

# Type 3360, 3361, AE3360, AE3361

Electromotive control valve



## Operating Instructions

We reserve the right to make technical changes without notice.  
Technische Änderungen vorbehalten.  
Sous réserve de modifications techniques.

© Bürkert Werke GmbH & Co. KG, 2016 – 2021

Operating Instructions 2101/05\_EUen\_00810490 / Original DE

## Electromotive control valve

### CONTENT

<b>1</b>	<b>OPERATING INSTRUCTIONS.....</b>	<b>8</b>
1.1	Symbols .....	8
1.2	Definition of terms.....	9
<b>2</b>	<b>INTENDED USE.....</b>	<b>10</b>
<b>3</b>	<b>BASIC SAFETY INSTRUCTIONS.....</b>	<b>11</b>
<b>4</b>	<b>GENERAL NOTES.....</b>	<b>13</b>
4.1	Contact address .....	13
4.2	Warranty.....	13
4.3	Information on the Internet.....	13
<b>5</b>	<b>PRODUCT DESCRIPTION.....</b>	<b>14</b>
5.1	General description .....	14
5.2	Properties .....	14
5.3	Variants.....	15
<b>6</b>	<b>STRUCTURE AND FUNCTION.....</b>	<b>17</b>
6.1	Representation – Structure of the electromotive control valve.....	18
6.2	Valve position after supply voltage failure.....	19
6.3	Safety position.....	19
6.4	Display of the device status .....	20
6.5	Factory settings .....	22
<b>7</b>	<b>CONTROL ELECTRONICS.....</b>	<b>23</b>
7.1	Functional diagram of the electromotive control valve.....	24
7.2	Functionality of the control electronics .....	25
7.3	Energy storage SAFEPOS energy-pack (option).....	28
<b>8</b>	<b>TECHNICAL DATA.....</b>	<b>29</b>
8.1	Conformity.....	29
8.2	Standards.....	29

8.3	Approvals .....	29
8.4	Type label .....	30
8.5	Operating conditions .....	31
8.6	General technical data .....	34
8.7	Electrical data .....	34
8.8	Flow rate values and flow rate characteristics for angle seat control valve (Type 3360).....	37
8.9	Flow rate values and flow rate characteristics for globe control valve (Type 3361).....	40
<b>9</b>	<b>INSTALLING THE VALVE.....</b>	<b>43</b>
9.1	Safety instructions .....	43
9.2	Installation of devices with threaded connection, flange connection or clamp connection .....	43
9.3	Installation of devices with welded connections.....	45
9.4	Disassembly of the actuator from the valve body .....	46
9.5	Installing actuator on valve body.....	49
9.6	Rotating the actuator .....	51
9.7	Holding device.....	52
<b>10</b>	<b>ELECTRICAL INSTALLATION .....</b>	<b>53</b>
10.1	Electrical installation with circular plug-in connector .....	53
10.2	Electrical connection Fieldbus gateway .....	57
10.3	Electrical installation with cable gland.....	58
<b>11</b>	<b>START-UP .....</b>	<b>65</b>
11.1	Safety instructions .....	65
11.2	Before start-up.....	65
11.3	Configuration options for start-up.....	65
11.4	Base settings .....	65
11.5	Set safety position .....	67
11.6	Adjustment of position controller – execute X.TUNE .....	68
11.7	Set standard signal for set-point position.....	70
11.8	Select physical unit for process control.....	71
11.9	Configure process values .....	72
11.10	Scaling the process control .....	73

11.11	Set dead band for process control .....	74
11.12	Setting up process control and executing P.LIN, P.TUNE.....	75
11.13	Set AUTOMATIC operating state.....	77
<b>12</b>	<b>OPERATION.....</b>	<b>78</b>
12.1	Overview: Availability of the operating elements .....	78
12.2	Display elements .....	79
12.3	Operating elements.....	81
12.4	büS service interface.....	82
12.5	SIM card – acquire and save data (option) .....	83
<b>13</b>	<b>DISPLAY OPERATION (OPTION).....</b>	<b>84</b>
13.1	User interface .....	84
13.2	Description of buttons.....	84
13.3	Display views.....	85
13.4	Description of symbols.....	89
13.5	Access rights and password protection.....	91
13.6	Screen saver.....	93
<b>14</b>	<b>BASIC FUNCTIONS.....</b>	<b>94</b>
14.1	Changing the operating state, AUTOMATIC, MANUAL .....	94
14.2	Enable – disable sealing function.....	97
14.3	Enabling – disabling correction characteristic .....	99
14.4	Change effective direction.....	102
14.5	Disabling process control .....	104
<b>15</b>	<b>MANUAL OVERRIDE OF VALVE.....</b>	<b>105</b>
15.1	Electrical override of valve on devices without a display module .....	105
15.2	Electrical override of valve on devices with a display module.....	107
15.3	Electrically actuating the valve using the Bürkert Communicator or display .....	108
15.4	Actuating the valve mechanically.....	109
<b>16</b>	<b>ADVANCED FUNCTIONS.....</b>	<b>114</b>

<b>17</b>	<b>OPERATING STRUCTURE AND FACTORY SETTING .....</b>	<b>115</b>
	17.1 Operating structure of the configuration area .....	115
	17.2 Context menu for operation on display .....	133
<b>18</b>	<b>INDUSTRIAL ETHERNET .....</b>	<b>135</b>
	18.1 Fieldbus gateway description .....	135
	18.2 Technical data Industrial Ethernet.....	137
	18.3 Projecting via fieldbus.....	138
	18.4 Web server.....	140
	18.5 Advanced functionalities.....	142
<b>19</b>	<b>CANopen.....</b>	<b>144</b>
	19.1 Projecting via fieldbus.....	144
	19.2 CANopen network configuration.....	144
<b>20</b>	<b>büS.....</b>	<b>145</b>
	20.1 Cabling of büS networks .....	145
	20.2 Configuration of büS networks .....	145
<b>21</b>	<b>MAINTENANCE .....</b>	<b>146</b>
	21.1 Safety instructions .....	146
	21.2 Actuator.....	146
	21.3 Wearing parts of the valve .....	146
	21.4 Visual inspection .....	147
	21.5 Maintenance notifications .....	147
<b>22</b>	<b>TROUBLESHOOTING AND MESSAGES .....</b>	<b>148</b>
	22.1 Error notifications .....	148
	22.2 Notifications on device status “Out of specification” .....	150
	22.3 Notifications on device status “Function check” .....	151
<b>23</b>	<b>CLEANING .....</b>	<b>151</b>

<b>24</b>	<b>ACCESSORIES, REPLACEMENT PARTS</b> .....	<b>152</b>
24.1	Communication software .....	153
24.2	Spare parts.....	154
24.3	Assembly tools.....	157
<b>25</b>	<b>DISASSEMBLY</b> .....	<b>158</b>
25.1	Safety instructions .....	158
<b>26</b>	<b>PACKAGING AND TRANSPORT</b> .....	<b>159</b>
<b>27</b>	<b>STORAGE</b> .....	<b>159</b>
<b>28</b>	<b>DISPOSAL</b> .....	<b>159</b>

MAN 1000274112 EN Version: G Status: RL (released | freigegeben) printed: 28.05.2021

# 1 OPERATING INSTRUCTIONS

The operating instructions describe the entire life cycle of the device. Keep these instructions in an easily accessible location for every user. The instructions must be available to each new owner of the device.

## Important safety information!

Carefully read through the operating instructions. Study in particular the chapters entitled *Basic safety instructions* and *Intended use*.

- ▶ The operating instructions must be read and understood.

## 1.1 Symbols



### DANGER!

**Warns of an immediate danger!**

- ▶ Failure to observe these instructions will result in death or serious injuries.



### WARNING!

**Warns of a potentially hazardous situation!**

- ▶ Failure to observe these instructions may result in serious injuries or death.



### CAUTION!

**Warns of a potential danger!**

- ▶ Failure to observe these instructions may result in moderate or minor injuries.

### NOTE!

**Warns of damage!**

- Failure to observe the warning may result in damage to the device or the equipment.



Indicates important additional information, tips and recommendations.



Refers to information in these operating instructions or in other documentation.

- ▶ Designates instructions to avoid danger.

→ Designates a procedure that you must carry out.



Designates a result.



Symbol for software interface texts.



## 1.2 Definition of terms

- **Device:** The term “Device” used in these instructions applies to the types described in these instructions:  
Type 3360, electromotive angle seat control valve  
Type 3361, electromotive globe control valve
- **Ex:** The abbreviation “Ex” used in these instructions stands for “potentially explosive”.
- The term “büS” (Bürkert system büS) used in this manual stands for the communication büS developed by Bürkert, based on the CANopen protocol.
- In these instructions, the unit bar stands for relative pressure. The absolute pressure is stated separately in bar(abs).

## 2 INTENDED USE

**Improper use of the electromotive Type 3360 and 3361 control valve may be dangerous for people, nearby equipment and the environment.**

**The electromotive control valve is designed to control the flow of liquid and gaseous media.**

- ▶ Standard devices must not be used in the potentially explosive area. They do not possess the separate “Ex” type label denoting the approval for use in potentially explosive environments.
- ▶ The use of alkaline cleaning agents is not permitted for cleaning the surface of the device.
- ▶ If the position of the valve has a bearing on safety concerns in the event of a power failure: Only use devices that have a SAFEPOS energy-pack (optional energy pack).
- ▶ When using the device, observe the authorised data, operating conditions and deployment conditions specified in the contract documents and in the operating instructions.
- ▶ Protect device from harmful environmental influences! (e.g. radiation, air humidity, fumes, etc.) For any matters requiring clarification, contact the relevant sales department.

### **Use the device**

- ▶ Use only in conjunction with third-party devices and components recommended or approved by Bürkert.
- ▶ only when in perfect condition and always ensure proper storage, transportation, installation and operation.
- ▶ only as intended.

### 3 BASIC SAFETY INSTRUCTIONS

These safety instructions do not take into account any unforeseen circumstances and events which occur during installation, operation and maintenance. The operator is responsible for observing the location-specific safety regulations, also with reference to personnel.



#### Risk of injury from high pressure.

- ▶ Before working on the system or device, switch off the pressure and vent or empty the lines.

#### Danger of burns and risk of fire.

Following an extended duty cycle or as a result of a hot medium, the surface of the device may become hot.

- ▶ Only touch the device when wearing protective gloves.
- ▶ Keep the device away from highly flammable substances and media.

#### Danger due to loud noises.

- ▶ Depending on the usage conditions, the device may generate loud noises. Detailed information on the probability of loud noises is available from the respective sales department.
- ▶ Wear hearing protection when in the vicinity of the device.

#### Discharge of medium if packing gland worn.

- ▶ Relief bore must be regularly inspected for any medium leakages.
- ▶ If medium is leaking from the relief bore, the packing gland must be replaced (see chapter "Maintenance").
- ▶ If the medium is hazardous, secure the area around the leakage to prevent risks.

#### Risk of crushing by mechanically powered parts.

- ▶ Installation work on the control cone, diaphragm and valve body must only be performed while electrically isolated. For devices with SAFEPOS energy-packs: Ensure that the SAFEPOS energy-pack is fully discharged. Wait until the LED ring is no longer lit and ensure that the LED status is not in "LED off" mode.
- ▶ Do not reach into the openings of the valve body.

#### Risk of uncontrolled process in the event of a power failure.

For devices without the optional SAFEPOS energy-pack, the valve will not stop in a defined position in the event of a power failure.

- ▶ If the position of the valve has a bearing on safety concerns in the event of a power failure: Only use devices that have a SAFEPOS energy-pack (optional energy pack).
- ▶ Select a valve position that is safe in respect of the process in the SAFEPOS menu.

**General hazardous situations.**

To prevent injury, ensure that:

- ▶ In potentially explosive environments the device must only be used in accordance with the specifications on the separate type label.
- ▶ The additional information and safety instructions relating to potentially explosive atmospheres enclosed with the device or the separate operating instructions relating to potentially explosive atmospheres must be heeded when using the device.
- ▶ In potentially explosive atmospheres, only use devices with a separate type label for use in such atmospheres.
- ▶ Feed only those media listed in chapter [“8 Technical data”](#) into the medium ports.
- ▶ Do not make any internal or external changes to the device and do not subject it to mechanical stress.
- ▶ Transport, install and dismantle a heavy device only with the aid of a second person and using suitable equipment.
- ▶ Secure the device against unintentional activation.
- ▶ Only trained technicians carry out installation and maintenance work.
- ▶ Following an interruption in the power supply, ensure that the process is restarted in a controlled manner. Observe the sequence.
  1. Connect supply voltage.
  2. Charge the device with medium.
- ▶ Observe general engineering standards & rules.
- ▶ The valves must be installed according to the regulations applicable in the country of use.

**NOTE!****Electrostatically sensitive components and assemblies.**

The device contains electronic components that are susceptible to the effects of electrostatic discharging (ESD). Components that come into contact with electrostatically charged persons or objects are at risk. In the worst-case scenario, they will be destroyed immediately or will fail after start-up.

- Observe the requirements for minimizing or avoiding the possibility of damage caused by sudden electrostatic discharge in accordance with EN 61340-5-1.
- Do not touch electronic components when the supply voltage is connected.

## 4 GENERAL NOTES

### 4.1 Contact address

#### Germany

Bürkert Fluid Control Systems  
Sales Center  
Christian-Bürkert-Str. 13-17  
D-74653 Ingelfingen  
Tel. + 49 (0) 7940 - 10-91 111  
Fax + 49 (0) 7940 - 10-91 448  
E-mail: [info@burkert.com](mailto:info@burkert.com)

#### International

The contact addresses can be found on the back pages of the printed operating instructions.

Also on the Internet at:

[country.burkert.com](http://country.burkert.com)

### 4.2 Warranty

A precondition for the warranty is that the device is used as intended and that the specified usage conditions are taken into account.

### 4.3 Information on the Internet

Operating instructions and data sheets for Types 3360 and 3361 can be found on the Internet at:

[country.burkert.com](http://country.burkert.com)

## 5 PRODUCT DESCRIPTION

### 5.1 General description

The electromotive control valve Type 3360 and 3361 is suitable for controlling the flow of liquid and gaseous media. This may be neutral gas, water, alcohol, oil, fuel, hydraulic fluid, salt solution, caustic soda, organic solvent or vapour.

The control valve has an electromotive linear actuator with actuation electronics assembly. The actuation electronics assembly for position control or process control is actuated either via standard signals (analogue) or a fieldbus (digital). The electromotive linear actuator is set up such that it is optimally effective. At the same time, when idling without power, it also keeps the valve sealed and in position even under the maximum specified operating pressure.

The device can also be equipped with the energy storage system (SAFEPOS energy-pack). In the event of a supply voltage failure, the energy storage system supplies the actuator with the energy required to move the valve to the position defined in the SAFEPOS menu.

The valve position can be manually changed in two ways.

1. Electrical manual override: used if supply voltage is present.
2. Mechanical manual override: must only be used if there is no supply voltage present.

The device can be set and operated either with 2 buttons and 4 DIP switches, or on a display with buttons for touch operation. It is also always possible to set the device with the büS service interface and by using the software Bürkert Communicator. The USB büS interface set, available as an accessory, is required for configuration with Bürkert Communicator.

One special characteristic of the Type 3361 globe control valve is the screwed-in valve seat, which can be replaced to reduce the seat size.

### 5.2 Properties

- High seal tightness due to self-adjusting packing gland.
- Devices with PTFE seal material are kept sealed without power.
- High flow rate values due to the stainless steel valve body that aids in flow.
- External, directly accessible display with buttons for touch operation.
- Mechanical position indicator shows the valve position even in the event of a supply voltage failure.
- 360° LED light ring for displaying device states, valve end positions and operating state.
- No electrical energy is required to hold the valve position even under maximum operating pressure, except for basic consumption for the control unit.
- Easy and quick replacement of the control cone.
- Valve actuator can rotate 360°.
- Integrated control unit for position control or process control.
- Contact-free, high-resolution and wear-free position sensor.
- The actuator housing consists of a robust and heat-dissipating aluminium body. The coating is resistant to common detergents. The plastics used for the actuator housing are also detergent-resistant.

### 5.2.1 Special characteristics of the 2-way globe control valve (Type 3361):

- Simple and quick replacement of the screwed-in valve seat.
- Large expansion space above the valve seat that prevents body erosion caused by cavitation.
- Optimal valve selection for the application.  
By default, 3 variants with different Kv values are available for each DN (5 variants of different Kv values for DN 1/2").

## 5.3 Variants

The following variants are described in these instructions:

#### Type 3360:

- Electromotive angle seat control valve with position control function
- Electromotive angle seat control valve with process control function

#### Type 3361:

- Electromotive globe control valve with position control function
- Electromotive globe control valve with process control function

### 5.3.1 Variants (valve sizes and actuator sizes)

#### Angle seat control valve Type 3360:

Available actuator size in nominal force [N]							
DN connection (valve body)		Seat size valve					
[DN]	[NPS]	15	20	25	32	40	50
15	1/2	1300	-	-	-	-	-
20	3/4	-	1300	-	-	-	-
25	1	-	-	1300	-	-	-
32	1 1/4	-	-	-	1300, 2500	-	-
40	1 1/2	-	-	-	-	1300, 2500	-
50	2	-	-	-	-	-	1300, 2500

Table 1: Angle seat control valve, Type 3360

**Globe control valve Type 3361:**

Available actuator size in nominal force [N]												
DN connection (valve body)		Seat size valve										
[DN]	[NPS]	3	4	6	8	10	15	20	25	32	40	50
10	3/8	1300	1300	1300	1300	1300	-	-	-	-	-	-
15	1/2	1300	1300	1300	1300	1300	1300	-	-	-	-	-
20	3/4		-	-	-	1300	1300	1300	-	-	-	-
25	1		-	-	-	-	1300	1300	1300	-	-	-
32	1 1/4		-	-	-	-	-	1300	1300	1300, 2500	-	-
40	1 1/2		-	-	-	-	-	-	1300	1300, 2500	1300, 2500	-
50	2		-	-	-	-	-	-	-	1300, 2500	1300, 2500	1300, 2500

Table 2: Globe control valve variants, Type 3361

### 5.3.2 Options

- Energy storage system (SAFEPOS energy-pack) for reaching safety position.  
The safety position that the valve is supposed to take in the event of a supply voltage failure is specified in the SAFEPOS menu.
- Various fieldbus systems for transmitting the control parameters.
- Display module, operated via touchscreen.
- SIM card for saving and transmitting device-specific values and settings.



## 6 STRUCTURE AND FUNCTION

The electromotive control valve consists of an electromotive linear actuator, a control cone and a 2-way globe valve body or a 2-way angle seat valve body.

The control electronics and "SAFEPOS energy-pack" are housed in the side of the linear actuator.

The control electronics consist of the microprocessor-controlled electronic mechanism and the position sensor.

The actuation electronics assembly for position control or process control is actuated either via standard signals (analogue) or a fieldbus (digital).

Standard devices are operated with 2 buttons and 4 DIP switches, while devices with a display module can be display-operated.

The electromotive linear actuator consists of a brushless direct current motor, a gear and a threaded spindle. The valve spindle connected to the threaded spindle transfers the force to the control cone.

- The linear actuator does not use any electrical energy when holding the valve position. This means that, when idling, only the control electronics require energy.
- The stainless steel valve body aids in flow and facilitates high flow rates.
- The self-adjusting packing gland guarantees a high degree of tightness.
- The control cone is connected to the actuator spindle via a spring-type straight pin, and can thus be quickly replaced.
- The actuator housing consists of a robust and heat-dissipating aluminium body with a detergent-resistant coating. The plastics used are also detergent-resistant.
- The flow direction is always below the valve seat.

### Valve seat:

- For a globe control valve, the valve seat is screwed-in.  
The seat size can easily be reduced by exchanging the screwed-in valve seat.
- For an angle seat control valve, the valve seat is integrated in the valve body. This means the seat size cannot be reduced.

The valve seat is always closed against the medium flow. The flow direction must thus be such that the flow reaches the valve below the seat.

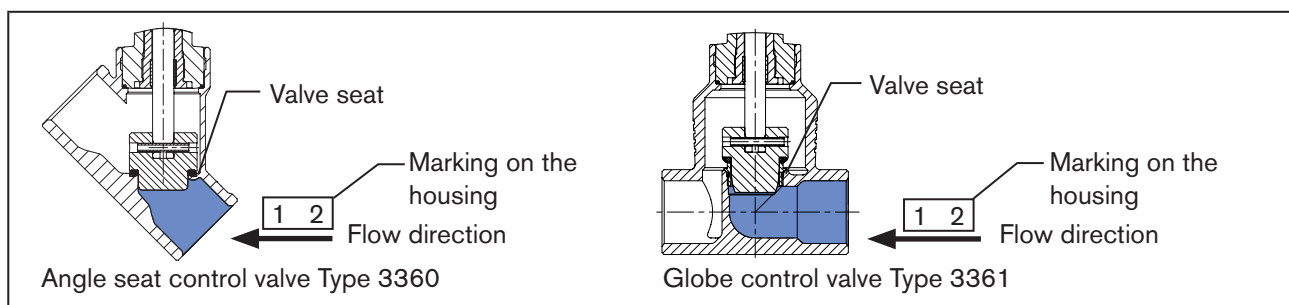

Image 1: Flow direction below seat, flow direction

### Fluidic connections:

- The threaded socket connection, welded connection or clamp connection are available for all valve bodies.
- The valve body with flange connection is also available for globe control valve Type 3361.

## 6.1 Representation – Structure of the electromotive control valve

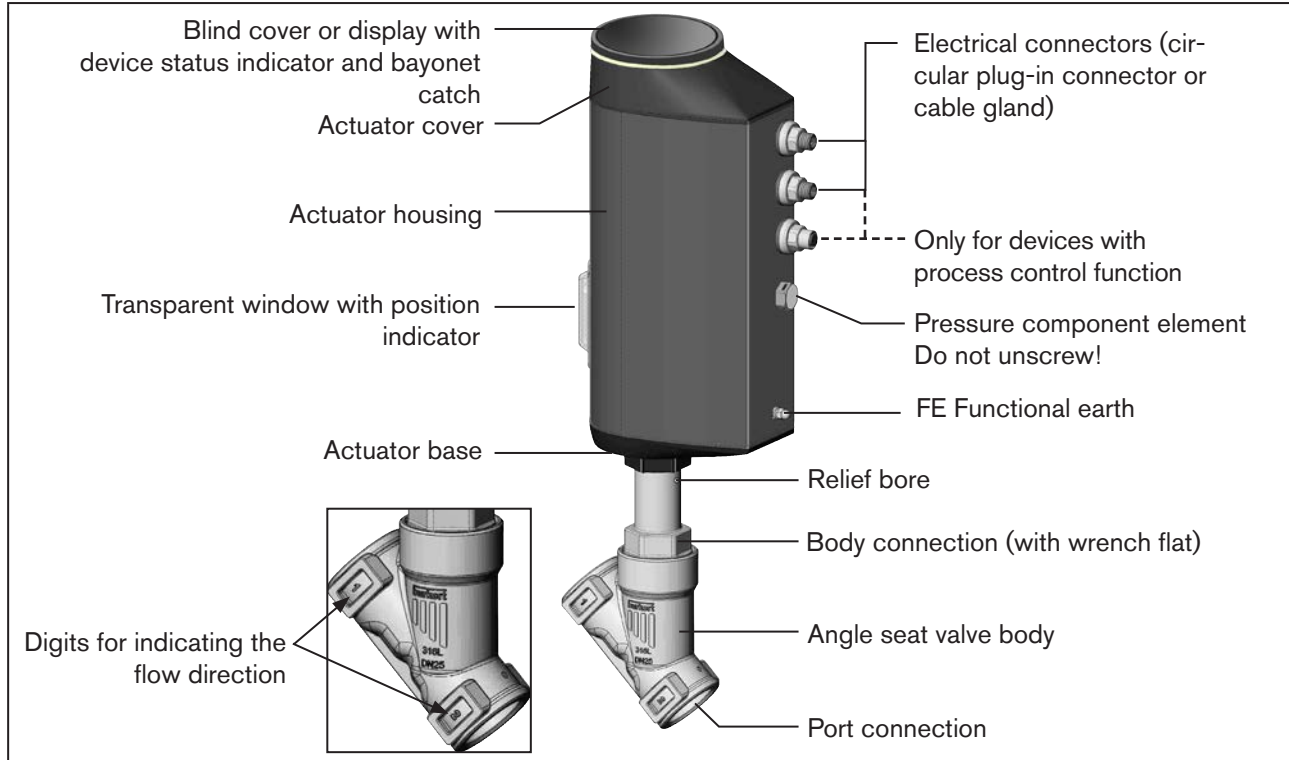

Image 2: Assembly, electromotive angle seat control valve Type 3360

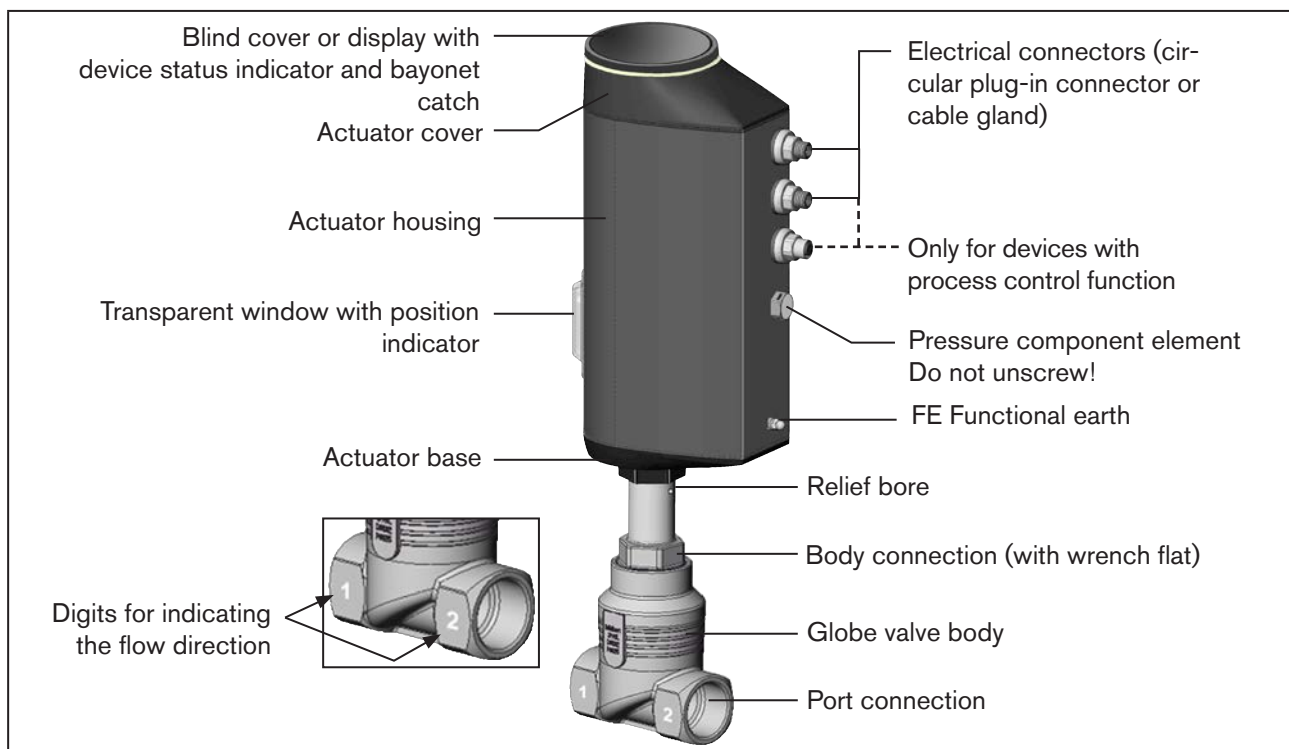

Image 3: Assembly, electromotive globe control valve Type 3361

## 6.2 Valve position after supply voltage failure

### Valve position for devices without the SAFEPOS energy-pack energy storage:

If the electromotive actuator idles upon a supply voltage failure, the valve remains in the last position that it was in.

If the supply voltage fails while the actuator is changing the valve position, the valve remains in an undefined position. The flywheel mass of the actuator and the operating pressure continue to influence the valve spindle until it finally idles.

### Valve position for devices with the SAFEPOS energy-pack energy storage:

The valve assumes the safety position defined in the SAFEPOS menu.



For a description of the SAFEPOS energy-pack energy storage system, see chapter [“7.3 Energy storage SAFEPOS energy-pack \(option\)”](#) on page 28

## 6.3 Safety position

The safety position that the valve assumes in the following scenarios is defined in the SAFEPOS menu:

- Internal error
- Cable break if parameterised accordingly
- Digital input if parameterised accordingly
- Supply voltage failure (optional)  
This function is only available in devices that have the optional SAFEPOS energy-pack energy storage accessory.

### The following safety positions are available to choose from in the SAFEPOS menu:

- Close = valve closed
- Open = valve opened
- User-Defined = freely defined safety position input by a per cent value (0% = closed, 100% = open).
- Inactive = valve remains in an undefined position in the event of a supply voltage failure.

## 6.4 Display of the device status

The device status is displayed on the LED light ring. Various LED modes may be configured to display the device's status and valve position:

- Valve mode
- Valve mode + warnings (factory pre-set)
- NAMUR operation mode



\* The description for setting the LED mode can be found in chapter [“12.2.2 Set LED operation mode”](#) on page 80.

### 6.4.1 Valve mode

The valve position and device status “Failure” are displayed in the valve mode.



Notifications on device statuses “Out of specification”, “Maintenance required” and “Function check” are not displayed in the valve mode.

The factory-set colours for displaying the valve positions “open” and “closed” can be switched. The described can be found in the software description for Types 3360, 3361 on our homepage [country.burkert.com](http://country.burkert.com)

#### Displays in valve mode:

If device status “Normal”: Continuously lit in the colour of the valve position.

For device status “Failure”: Alternating flashing between red and the valve position colour.

Valve position	Colour for valve position	Colour for device status “Failure”
open	yellow	red
in between	white	
closed	green	

Table 3: Display of device status in valve mode

### 6.4.2 Valve mode + warnings

In this operation mode, the valve position and device statuses “Failure”, “Out of specification”, “Maintenance required” and “Function check” are displayed.

If several device statuses exist simultaneously, the device status with the highest priority is displayed. The priority is based on the severity of the deviation from standard operation (red = failure = highest priority).

#### Displays in valve mode + warnings:

For device status “Normal”: Continuously lit in the colour of the valve position.

If device status is not “Normal”: Flashes alternately with the colours for the valve position and the device status.

Valve position	Colour for valve position	Colour for device status			
		Failure, error or fault	Function check	Outside of specification	Maintenance required
open	yellow	red	orange	yellow	Blue
in between	white				
closed	green				

Table 4: Display of device status in valve mode + warnings

### 6.4.3 NAMUR operation mode

In NAMUR mode the LED light ring lights up in the colour specified for the device status as per NAMUR NE 107.

If several device statuses exist simultaneously, the device status with the highest priority is displayed. The priority is based on the severity of the deviation from standard operation (red = failure = highest priority).

Indicators in NAMUR operation mode:

Status LED in line with NE 107, issue 2006-06-12			
Colour	Colour code	Description	Meaning
red	5	Failure, error or fault	Due to a malfunction in the device or its peripherals, closed-loop control mode is not possible.
orange	4	Function check	Work is being carried out on the device, which means that closed-loop control mode is temporarily not possible.
yellow	3	Outside of specification	The environment conditions or process conditions for the device are not within the specified range. Internal device diagnostics indicate problems within the device or with the process properties.
Blue	2	Maintenance required	The device is in closed-loop control mode, but function will soon be restricted. → Perform device maintenance.
green	1	Diagnostics active	Device is in error-free operation. Status changes are highlighted in colour. Messages are sent via any fieldbus that may be connected.
white	0	Diagnostics inactive	Device is switched on. Status changes are not displayed. Messages are not transferred via a fieldbus that may be connected.

Table 5: Indication of the device status in NAMUR operation mode



\* A detailed fault description can be found in chapter [“22 Troubleshooting and messages”](#) on page [148](#).

### 6.4.4 Flashing of the LED light ring

Flashing indicates that a connection with the software Bürkert Communicator has been established.

### 6.4.5 Notifications on device status

Notifications on device status are recorded in the logbook. Chapter [“21 Maintenance”](#) contains the most common notifications and the measures that they require.

#### Notifications on device status “Function check”

The notifications are presented when closed-loop control mode is interrupted by work on the device.

Notifications on device status "Function check"
MANUAL operating state active
X.TUNE active
P.TUNE active
P.LIN active
Process Simulation active
Signal generator active

Table 6: Notifications on device status "Function check"

## 6.5 Factory settings



**Operating state:**  
Devices in their factory default state have their operating state preset to MANUAL.

The pre-set factory settings for the individual menu options can be found in chapter ["17 Operating structure and factory setting"](#).

The factory settings are depicted in blue in the operating structure to the right of the menu.

## 7 CONTROL ELECTRONICS

- **Variants**  
Types 3360, 3361 with position control function  
Types 3360, 3361 with process control function
- **Position sensor**  
contact-free, high-resolution and wear-free.
- **Microprocessor-controlled electronics assembly**  
for signal processing, closed-loop control and motor control.
- **Electrical interfaces**  
(circular plug-in connector or cable gland)

### 7.5.1 Interfaces

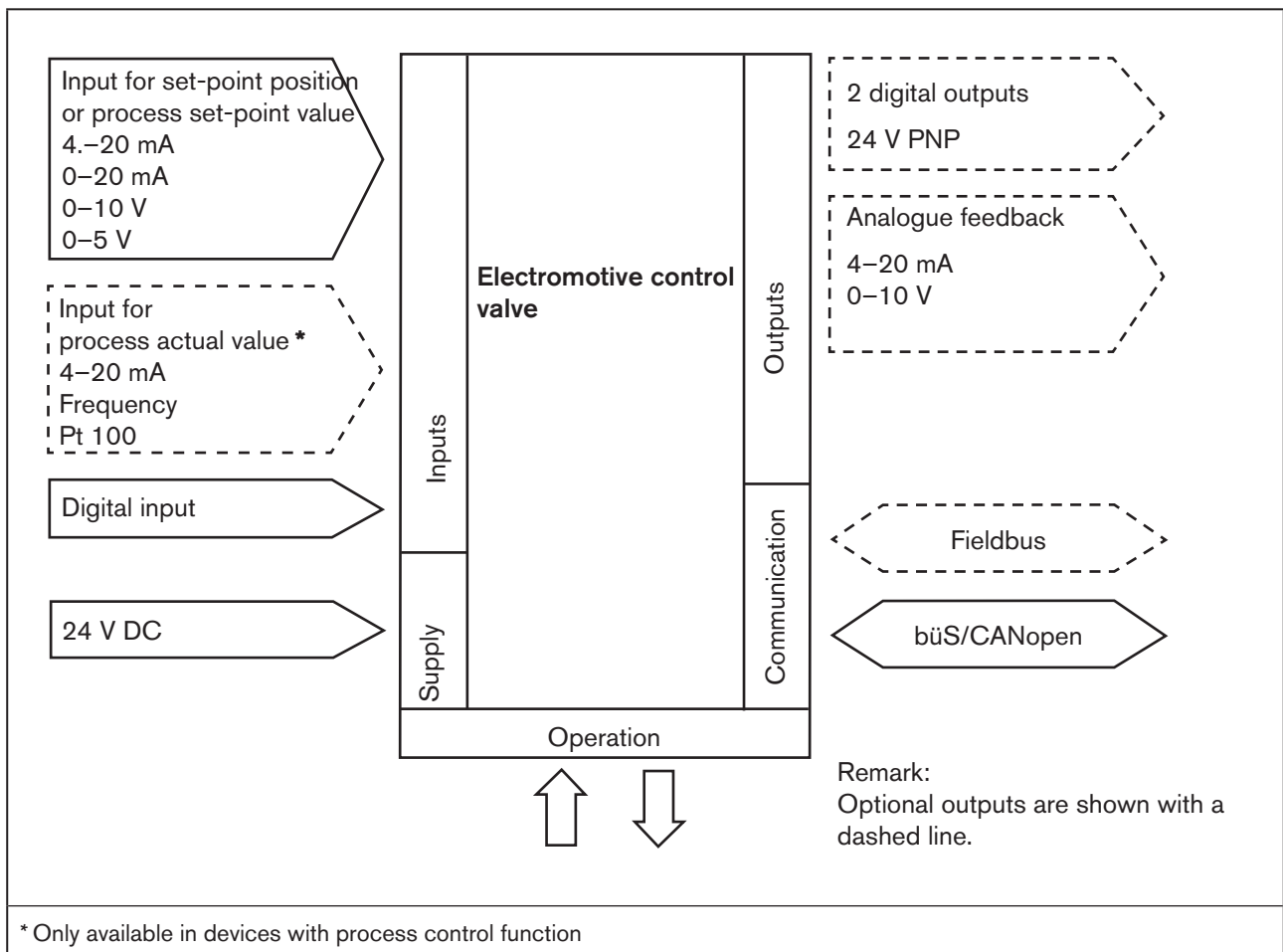

Image 4: Interfaces of the electromotive control valve



The electromotive control valve is designed with the three-wire technique, i.e. the electrical supply (24 V DC) is separate from the set-point signal.

## 7.1 Functional diagram of the electromotive control valve

The black parts of the image describe the position control function. The additional elements for the process control function (optional) are depicted in blue.

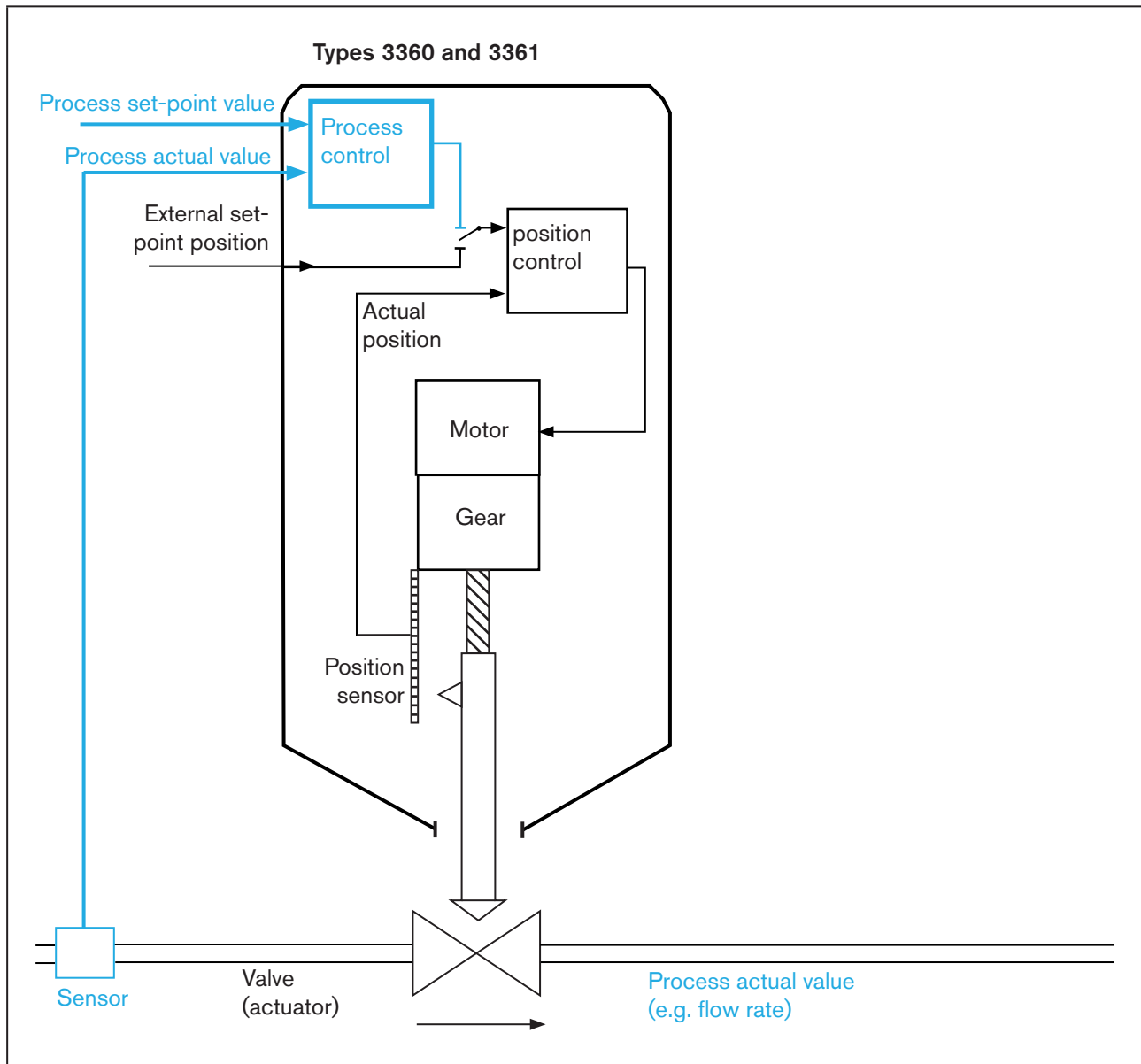

Image 5: Functional diagram, electromotive control valve



## 7.2 Functionality of the control electronics

The additionally implemented PID controller can, except for the position control, also be used to conduct a process control (e.g. level, pressure, flow rate, temperature) for purposes of cascade control.

The process control function is integrated in a control loop. The set-point position of the valve is derived from the process set-point value and the process actual value, with the control parameters (PID controller). The process set-point value can be specified by an external signal.

For process control, the position control becomes an auxiliary control loop, which in turn creates a cascade control. The process controller in the main control loop of the control valve has a PID function. The process set-point value (SP) is specified as the set-point value and compared with the actual value (PV) of the measured variable being controlled. The position sensor records the actual position (POS) of the electromotive linear actuator. The position control compares this actual position with the set-point value (CMD) of the process control. If there is a control difference ( $X_{d1}$ ), the actuating variable (CTRL) is used to change the actual position (POS) and thus the valve opening.

### Signal flow diagram

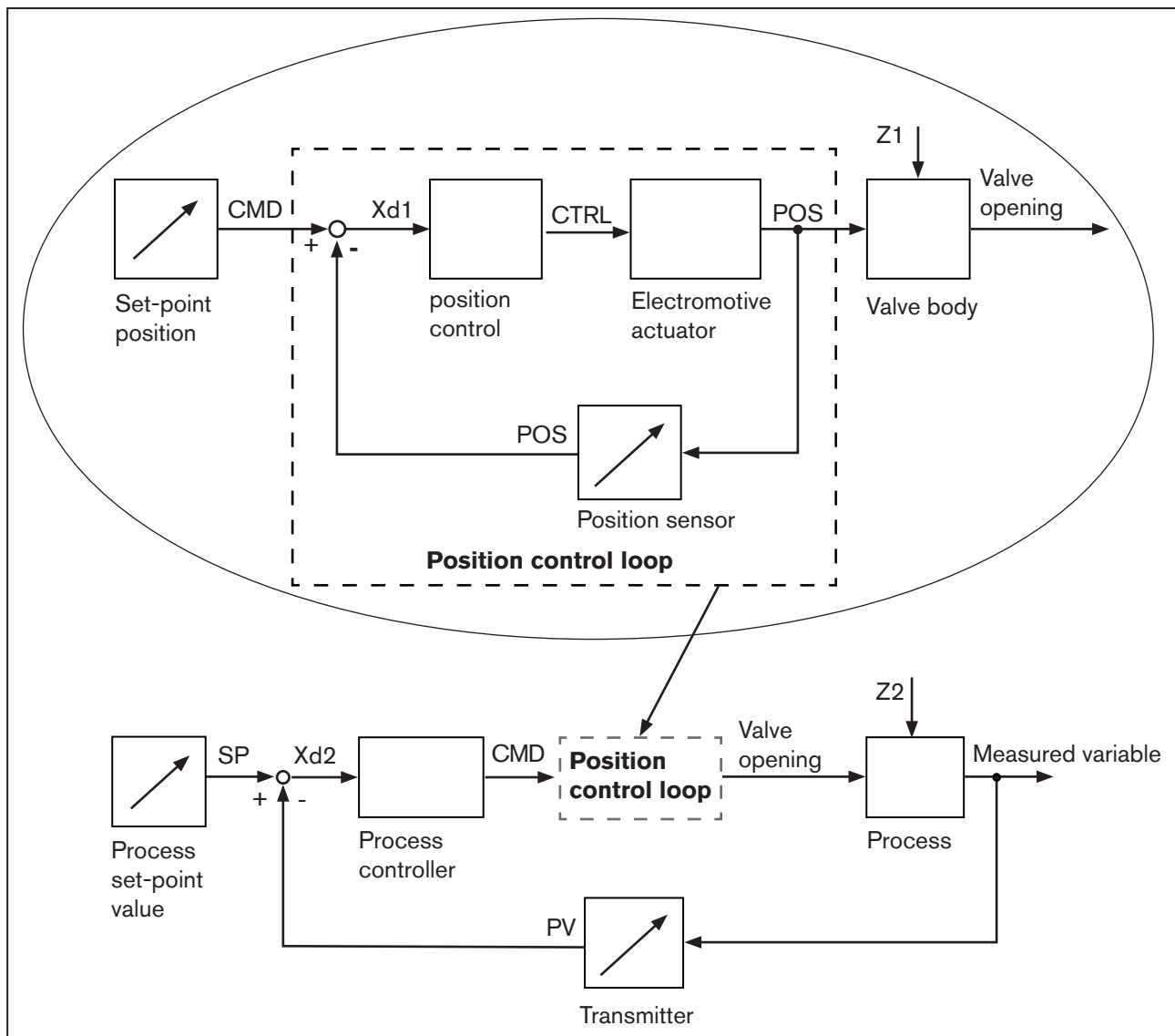

Image 6: Signal flow diagram

### 7.2.1 Schematic presentation of the position control

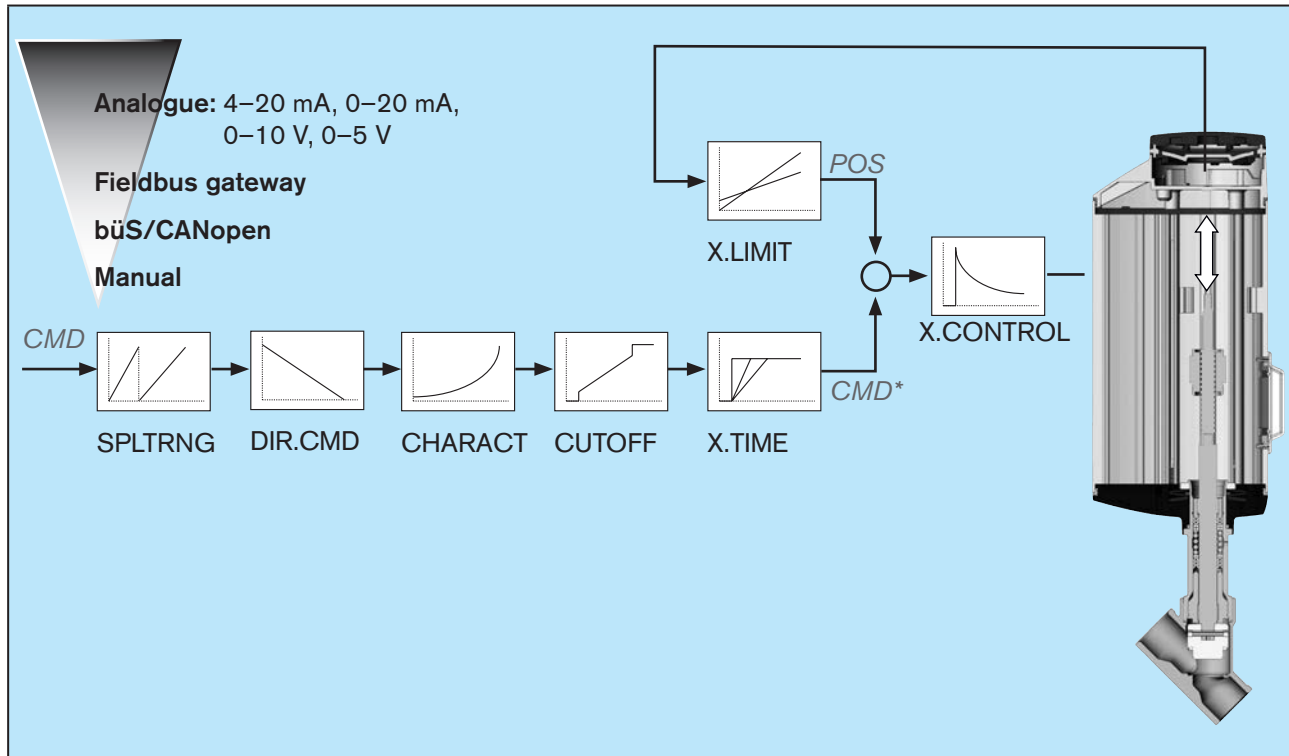

Image 7: Schematic presentation of the position control

#### Legend for the schematic representation of position control and process control:

Menu	Description
X.LIMIT	Mechanical stroke range limit
DIR.CMD	Set-point position direction
SPLTRNG	Signal split range
CHARACT	Transfer characteristic
CUTOFF (type X.CO) (type P.CO)	Sealing function (based on set-point position) (based on process set-point value)
X.TIME	Position control setting speed limit
X.CONTROL	Position control parameterisation
SP.scale	Scaling process set-point value
SP.SLOPE	Increase rate per seconde
SP.FILTER	Process set-point value filter
PV.scale	Scaling process actual value
PV FILTER	Process actual value filter
PID.PARAMETER	Process control parameterisation
P.CO. scale	Scaling process control

Table 7: Legend, position control and process control menu

MAN 1000274112 EN Version: G Status: RL (released | freigegeben) printed: 28.05.2021

Measured variables	Description
POS	Actual position
CMD	Set-point position
	Position controller function: Selection of the source for the input signal of the set-point position in the menu → <b>Inputs/outputs</b> → <b>CMD</b> → <b>CMD.source</b> . Process controller function: the set-point position is specified by the process controller.
CMD*	Set-point position processed by the controller
PV	Process actual value: Selection of the source for the input signal of the process actual value in the menu → <b>Inputs/outputs</b> → <b>PV</b> → <b>PV.source</b> .
PV*	Process actual value processed by the controller
SP	Process set-point value: Selection of the source for the input signal of the process set-point value in the menu → <b>Inputs/outputs</b> → <b>SP I CMD</b> → <b>SP.source</b> .
SP*	Process set-point value processed by the controller

Table 8: Legend, position control and process control measured variables

### 7.2.2 Schematic presentation of the process control

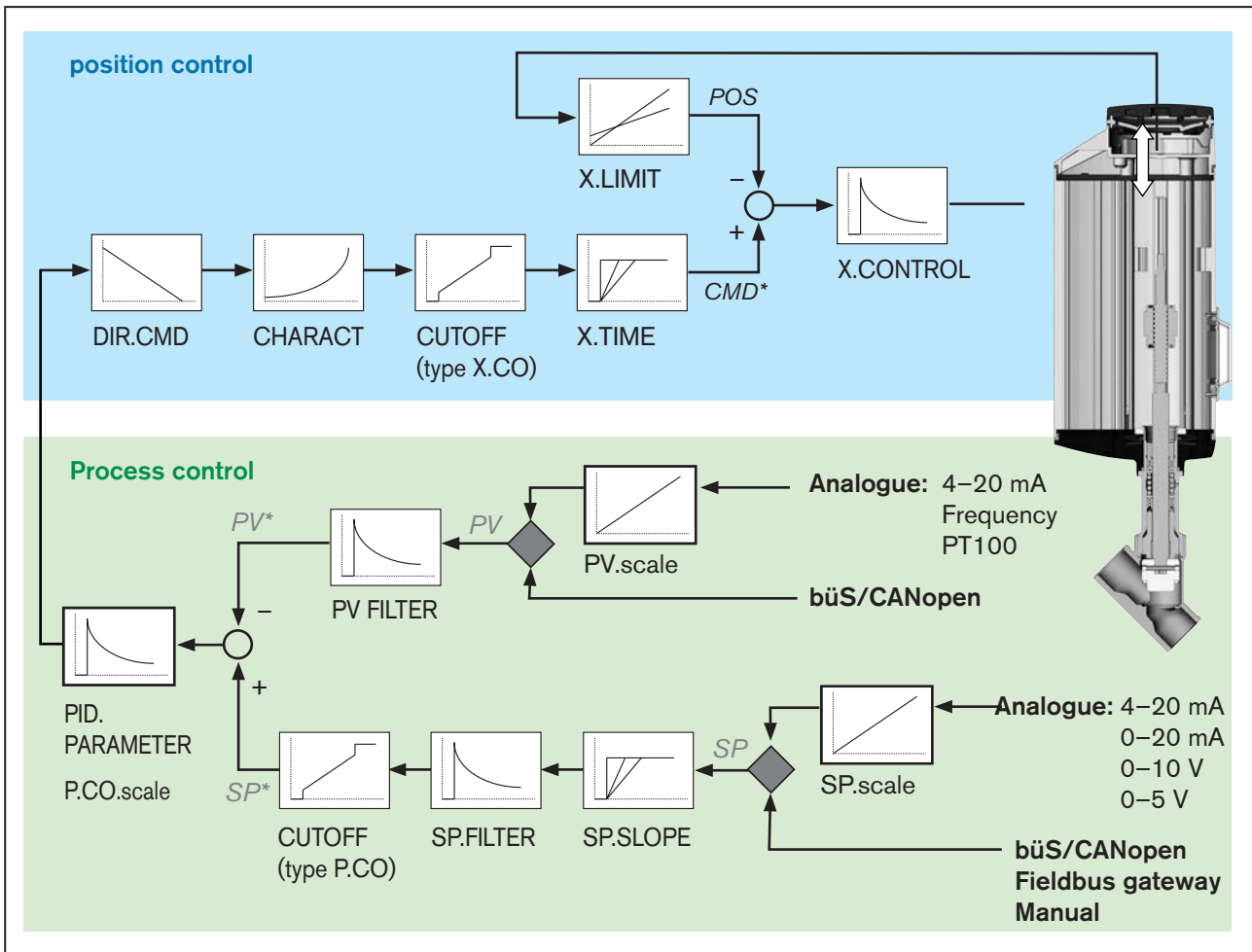

MAN 1000274112 EN Version: G Status: RL (released | freigegeben) printed: 28.05.2021

Image 8: Schematic presentation of the process control

## 7.3 Energy storage SAFEPOS energy-pack (option)

The device can also be equipped with the energy storage system (SAFEPOS energy-pack). In the event of a supply voltage failure, the energy storage system supplies the actuator with the energy required to move the valve to the position defined in the SAFEPOS menu. After a maximum of 100 seconds (depending on operating conditions), the energy storage is fully charged and ready for operation.

### 7.3.1 Service life

Service life: up to 10 years (depending on operating conditions).

The service life of 5 years was calculated based on the following conditions:

Ambient temperature	30 °C
Medium temperature	165 °C
Duty cycle	100%
Operating pressure	5 bar
DN	DN32

#### NOTE!

The energy storage system SAFEPOS energy-pack is a wearing part. The service life figures are approximate values that cannot be guaranteed.

### 7.3.2 Notifications on the state of the SAFEPOS energy-pack

#### The device issues a maintenance notification:

The remaining service life of the energy pack is around 25%! The energy pack needs to be replaced soon.

- ▶  The SAFEPOS energy-pack must be promptly replaced before the end of its service life.

#### The device issues an error alert and assumes the safety position:

The SAFEPOS energy-pack was not promptly replaced before issuance of the warning. The storage capacity is so low that assumption of the safety position can no longer be guaranteed.

## 8 TECHNICAL DATA



The following product-specific information is provided on the type label:

- Voltage [V] (tolerance  $\pm 10\%$ ) and current type
- Seal material of the valve body
- Fieldbus standard
- Flow capacity
- Actuator size
- Maximum permitted operating pressure
- Flow direction

### 8.1 Conformity

The electromotive control valve Type 3360, 3361 are compliant with the EU directives in relation to the EU Declaration of Conformity (if applicable).

### 8.2 Standards

The applied standards, which are used to demonstrate conformity with the directives, are listed in the EU type examination certificate and/or the EU Declaration of Conformity (if applicable).

### 8.3 Approvals

The product is cULus listed. Refer to chapter [“8.7 Electrical data”](#) for information on use in UL environments.

## 8.4 Type label

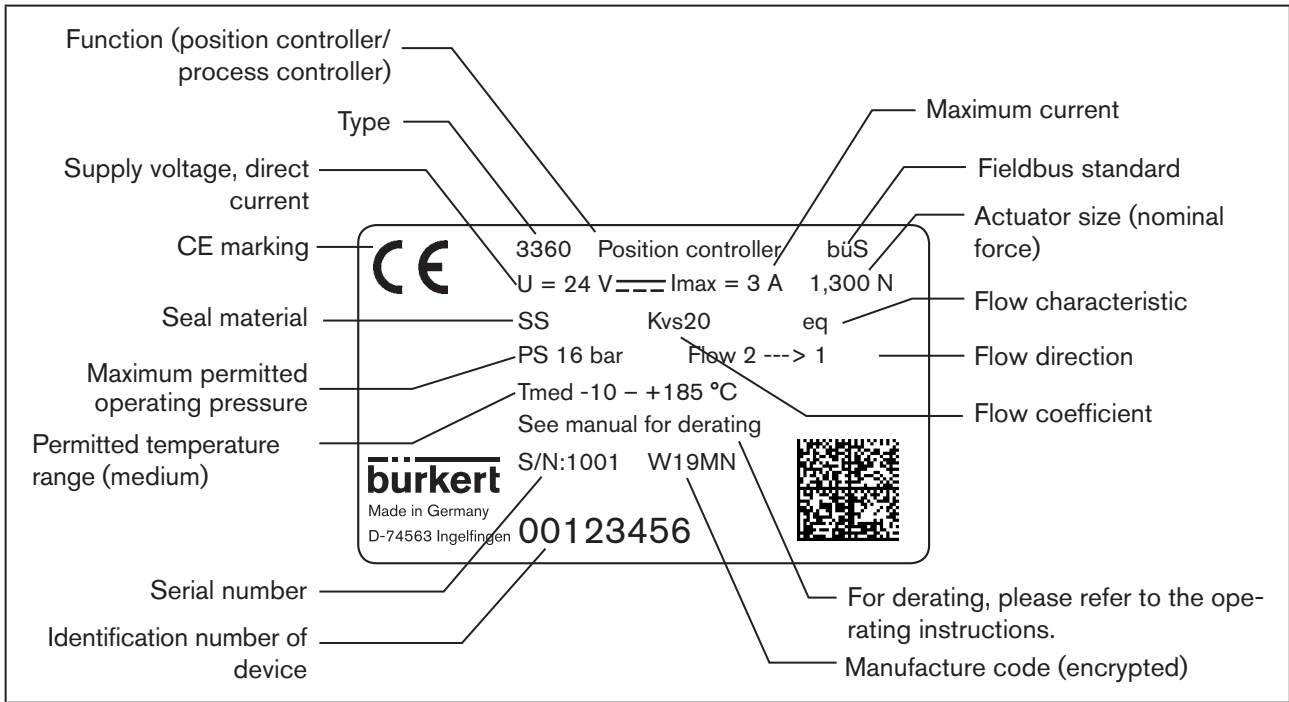

Image 9: Description of the type label (example)

### 8.4.1 UL additional label (example)

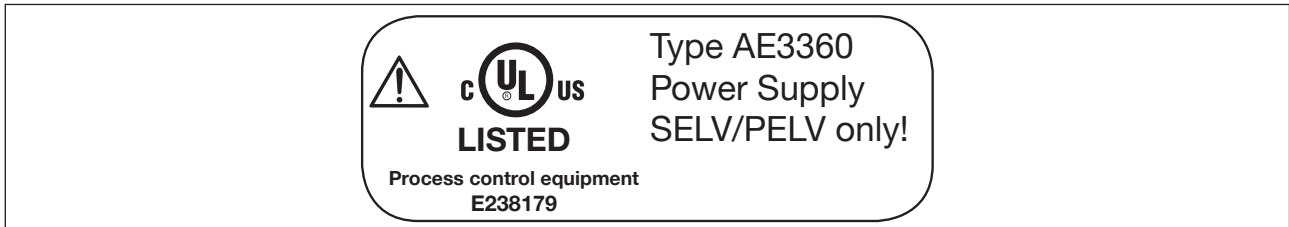

Image 10: UL additional label (example)

## 8.5 Operating conditions



The product-specific information on the type label must be heeded when operating the device.



### WARNING!

**Loss of function if operated below or above permitted temperature range.**

- ▶ Never expose the device to direct sunlight in outdoor areas.
- ▶ Do not operate above or below the permitted ambient temperature range.



### WARNING!

**Reduced sealing function if operating pressure too high.**

Because the valve seat is closed against the medium flow, an excessive operating pressure may cause the valve seat to not close tightly.

- ▶ The operating pressure must not exceed the maximum value specified on the type label.

Maximum permitted operating pressure: see type label, depending on usage limits of the armature  
(derating operating pressure)

Media: neutral gases and steam.  
Liquid media: Water, alcohol, oil, fuel, hydraulic fluid, salt solution, caustic soda, organic solvent.

Degree of protection: (verified by Bürkert/not evaluated by UL)  
IP65 in accordance with IEC 529, EN 60529, (IP67 on demand).  
NEMA 250 4x (not guaranteed for installation position: actuator facing downwards).

Flow direction: indicated on the type label with an arrow and the digits 1 and 2.  
The 1 and 2 are also on the valve body for identification.  
The flow direction is below the seat with flow from port 2 to port 1.

Altitude Up to 2000 m above sea level

### 8.5.1 Permitted temperature ranges

Minimum temperatures Environment: -25 °C  
Medium: -10 °C (-40 °C on request)

Maximum temperatures Environment: depends on the medium temperature, see subsequent temperature diagram.  
Medium: depends on the ambient temperature; see temperature diagram below, as well as usage limits of the valve (derating operating pressure).  
For devices with PTFE valve seat seal max. +130 °C.  
For devices with stainless steel or PEEK valve seat seal max. +185 °C (+230 °C on request).

**Temperature diagram**

The maximum permitted temperature for the environment and medium are dependent on one another. The permitted maximum temperatures of the device variants can be determined using the characteristics of the temperature diagram.

The values are calculated under the following maximum operating conditions: DN32 at 100% duty cycle with 16 bar operating pressure.

Individual reviews may be performed under different operating conditions. For this, please contact your Bürkert branch office.

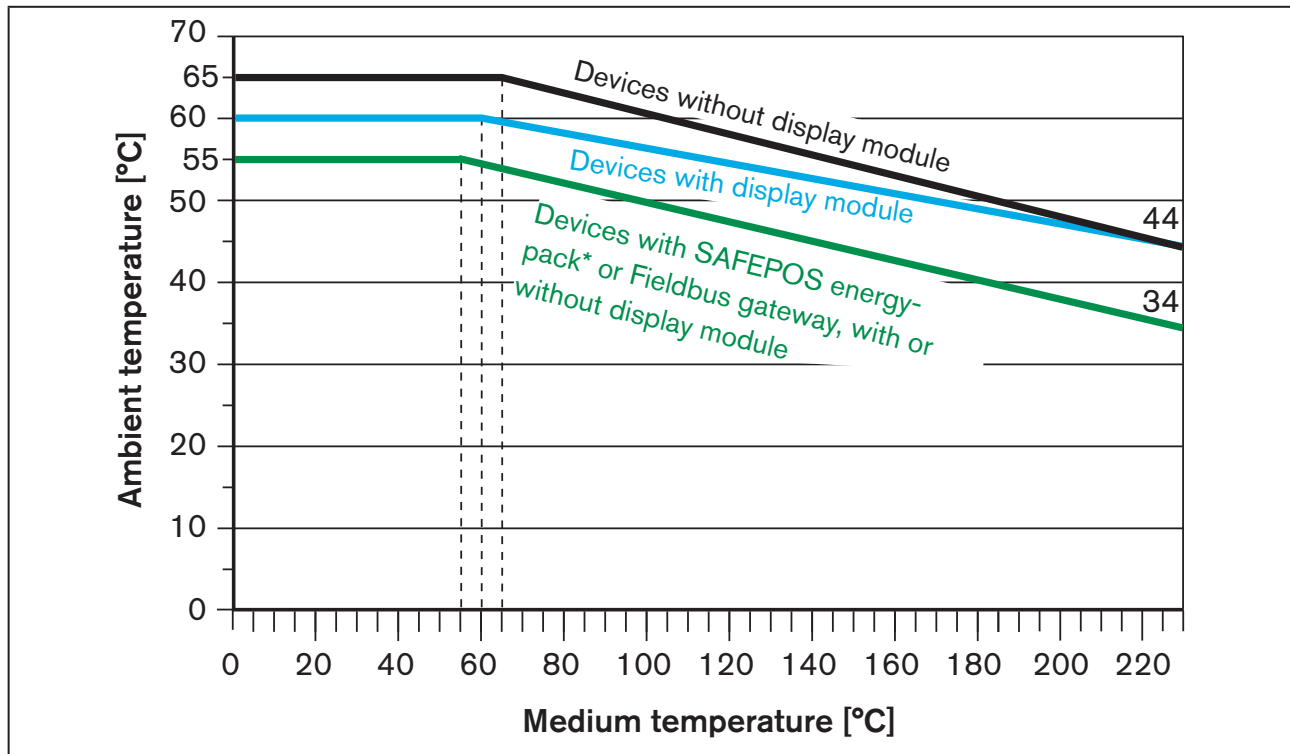

Image 11: Temperature diagram



\*The service life of the SAFEPOS energy-pack is dependent on the medium temperature and ambient temperature. For a description see [“7.3 Energy storage SAFEPOS energy-pack \(option\)”](#)



## Derating pressure and temperature ranges

Usage limits of the valve (derating operating pressure)

Medium temperature	Operating pressure
-10 – +50 °C	25 bar
100 °C	24.5 bar
150 °C	22.4 bar
200 °C	20.3 bar
230 °C	19 bar

Table 9: Derating the operating pressure as per DIN EN 12516-1/PN25

Medium temperature	Operating pressure
-29 – +38 °C	19 bar
50 °C	18.4 bar
100 °C	16.2 bar
150 °C	14.8 bar
200 °C	13.7 bar
230 °C	12.7 bar

Table 10: Derating the operating pressure as per ASME B16.5/ASME B16.34 Cl.150

Medium temperature	Operating pressure
-10 – +50 °C	14 bar
100 °C	14 bar
150 °C	13.4 bar
200 °C	12.4 bar
230 °C	11.7 bar

Table 11: Derating the operating pressure as per JIS B 2220 10K

## 8.6 General technical data

Dimensions:	see data sheet												
Weight:	see data sheet												
Materials:	<table> <tr> <td>Actuator:</td> <td>PPS and aluminium, powder-coated</td> </tr> <tr> <td>valve body:</td> <td>316L</td> </tr> <tr> <td>body connection:</td> <td>316L/1.4401</td> </tr> <tr> <td>spindle:</td> <td>1.4401/1.4404</td> </tr> <tr> <td>spindle guide:</td> <td>1.4401/1.4404/316L with carbon-filled PTFE</td> </tr> <tr> <td>packing gland</td> <td>PTFE V-rings with spring compensation (carbon-filled PTFE)</td> </tr> </table>	Actuator:	PPS and aluminium, powder-coated	valve body:	316L	body connection:	316L/1.4401	spindle:	1.4401/1.4404	spindle guide:	1.4401/1.4404/316L with carbon-filled PTFE	packing gland	PTFE V-rings with spring compensation (carbon-filled PTFE)
Actuator:	PPS and aluminium, powder-coated												
valve body:	316L												
body connection:	316L/1.4401												
spindle:	1.4401/1.4404												
spindle guide:	1.4401/1.4404/316L with carbon-filled PTFE												
packing gland	PTFE V-rings with spring compensation (carbon-filled PTFE)												
Seal material:	<table> <tr> <td>Actuator housing sealing element:</td> <td>EPDM</td> </tr> <tr> <td>valve seat seal:</td> <td>see type label</td> </tr> </table>	Actuator housing sealing element:	EPDM	valve seat seal:	see type label								
Actuator housing sealing element:	EPDM												
valve seat seal:	see type label												
Fluid connection:	<p>Possible connection types: Threaded socket connection G 1/2...G 2 (NPT, RC on request) Welded connection as per EN ISO 1127 (ISO 4200), DIN 11850 series 2</p> <p>Clamp connection as per ISO 2852, DIN 32676, ASME BPE, BS 4825</p> <p>Additionally for Type 3361 globe control valve: Flange connection as per DIN 2634, ANSI B16.5 class 150, JIS 10K</p> <p>Other connections on request</p>												
Electrical connection:	with terminal connectors or circular plug-in connectors												
Installation position:	any, preferably actuator face up												
Sound pressure level:	< 70 dB (A), may be higher depending on the operating conditions.												
Kv value:	see type label or chapters <a href="#">"8.8"</a> and <a href="#">"8.9"</a>												

## 8.7 Electrical data



### WARNING!

#### Electrical shock.

Protection class III is only guaranteed when using an SELV or PELV power supply unit.

Protection class	3 in accordance with DIN EN 61140
Electrical connections	<p>Devices with position control function: Terminal strip with cable gland, 2x M20 or 2 circular plug-in connectors M12, 5-pin und 8-pin</p> <p>Devices with process control function: Terminal strip with cable gland, 3x M20 or circular plug-in connectors 2x M12, 5-pin and 1x M12, 8-pin</p>

### NOTE!

Consider voltage drop through power supply cable.  
Example: With a cable cross-section of 0.34 mm<sup>2</sup> the copper cable must not be more than 8 metres in length.

Operating voltage	24 V $\pm$ 10%, max. residual ripple 10%
Operating current [A]*	max. 3 A (at 25 °C). including actuator at max. load and charging current of optional SAFEPOS energy-pack (charging current approx. 1 A) for design of power supply unit
Supply voltage transmitter	24 V $\pm$ 10% only for devices with process control function.
Supply current transmitter	max. 150 mA only for devices with process control function.
Standby consumption (electronics assembly without actuator) [W]*	
Standard consumption:	minimum 2 W Typically 3 W
Analogue & digital output option:	0.5 W
SAFEPOS energy-pack:	0.5 W
Fieldbus gateway:	1 W
Energy consumption of actuator for 1 cycle (closing against operating pressure, opening with operating pressure) [Ws]*	min. 36 Ws max. 140 Ws (depending on device variant and operating conditions)



The operating current can be reduced by the following measures, if necessary

1. For devices with the SAFEPOS energy-pack energy storage:  
Setting the function "Control if ready" reduces the max. operating pressure by 1 A.

Setting in the configuration area **Position controller** → **Parameter** → **SAFEPOS** → **ENERGY-PACK** → **FUNCTION** → **Control if ready**.

2. Reducing the control speed X.TIME.

Setting: Setting in the configuration area **Position controller** → **Parameter** → **ADD.FUNCTION** → Activate **X.TIME** → **X.TIME** → **Opening time** → **Closing time**.

Service life of energy storage	
SAFEPOS energy-pack	Charging time: maximum 100 seconds (depending on operating conditions) Service life: up to 10 years (depending on operating conditions). The service life of 5 years was calculated based on the following conditions:
	Ambient temperature 30 °C
	Medium temperature 165 °C
	Duty cycle 100%
	Operating pressure 5 bar
	Diameter nominal DN32

\* All values relate to a supply voltage of 24 V  $\pm$  10% at an ambient and medium temperature of 25 °C.

**Note:** At minimum ambient and medium temperatures, the operating current can be up to 5 A (incl. 1 A charging current for the optional SAFEPOS energy-pack).

**Analogue inputs:** (electrically isolated from the supply voltage and analogue output)

Input data for set-point value signal

0/4–20 mA:	Input resistance	60 Ω
	Resolution	12-bit
0–5/10 V:	Input resistance	22 kΩ
	Resolution	12-bit, resolution relates to 0–10 V

Input data for actual value signal (optional)

4–20 mA:	Input resistance	60 Ω
	Resolution	12-bit
Frequency:	Measuring range	0.2–6500 Hz
	Input resistance	> 30 kΩ
	Accuracy	0.1% from measured value
	Input signal	> 300 mV <sub>ss</sub>
	Signal form	Sine wave, square wave, triangle wave
Pt 100:	Measuring range	-20 – +220 °C
	Accuracy	0.01 °C
	Measuring current	1 mA

**Analogue output (optional):**

max. current	10 mA (for voltage output 0–5/10 V)
Load	0–800 Ω (for current output 0/4–20 mA)

**Digital outputs (optional):**

Current limit	100 mA
---------------	--------

**Digital inputs:**

0–5 V = log “0”, 10–30 V = log “1”  
inverted input inverted accordingly (input current < 6 mA)

**Communication interface with PC:**

büS service interface, connection is established using the USB büS interface

**Communication software for PC:**

“Bürkert Communicator”



The digital input, digital outputs and analogue output are not electrically isolated from the operating voltage. They relate to the GND potential of the operating voltage.

Current limit: Output voltage is reduced in the event of overload.

## 8.8 Flow rate values and flow rate characteristics for angle seat control valve (Type 3360)

The flow rate values and resulting characteristic depend on the valve seat size.

### 8.8.1 Flow rate values and flow rate characteristic for seat size 15

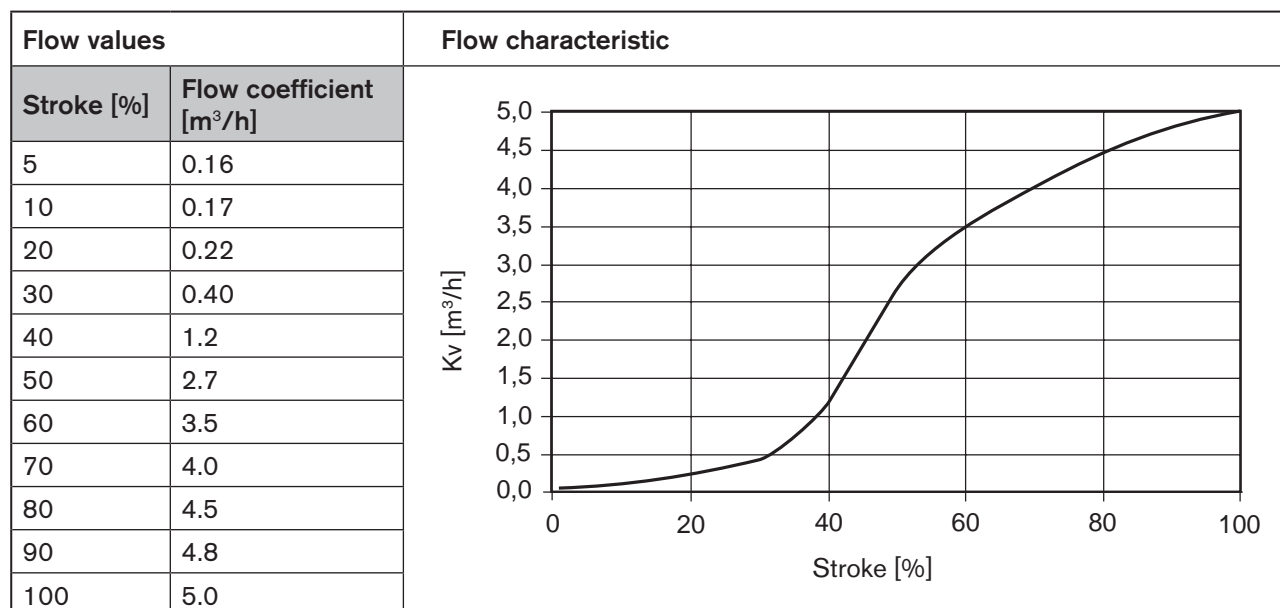

Table 12: Angle seat control valve, flow rate values and flow rate characteristic for seat size 15

### 8.8.2 Flow rate values and flow rate characteristic for seat size 20

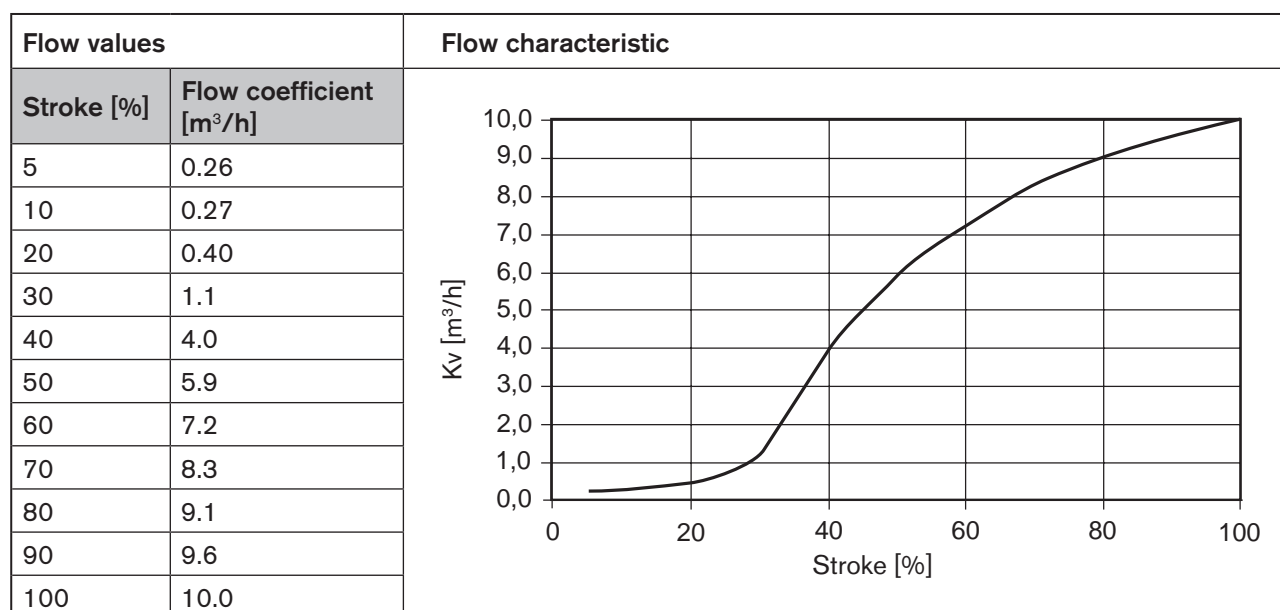

Table 13: Angle seat control valve, flow rate values and flow rate characteristic for seat size 20

### 8.8.3 Flow rate values and flow rate characteristic for seat size 25

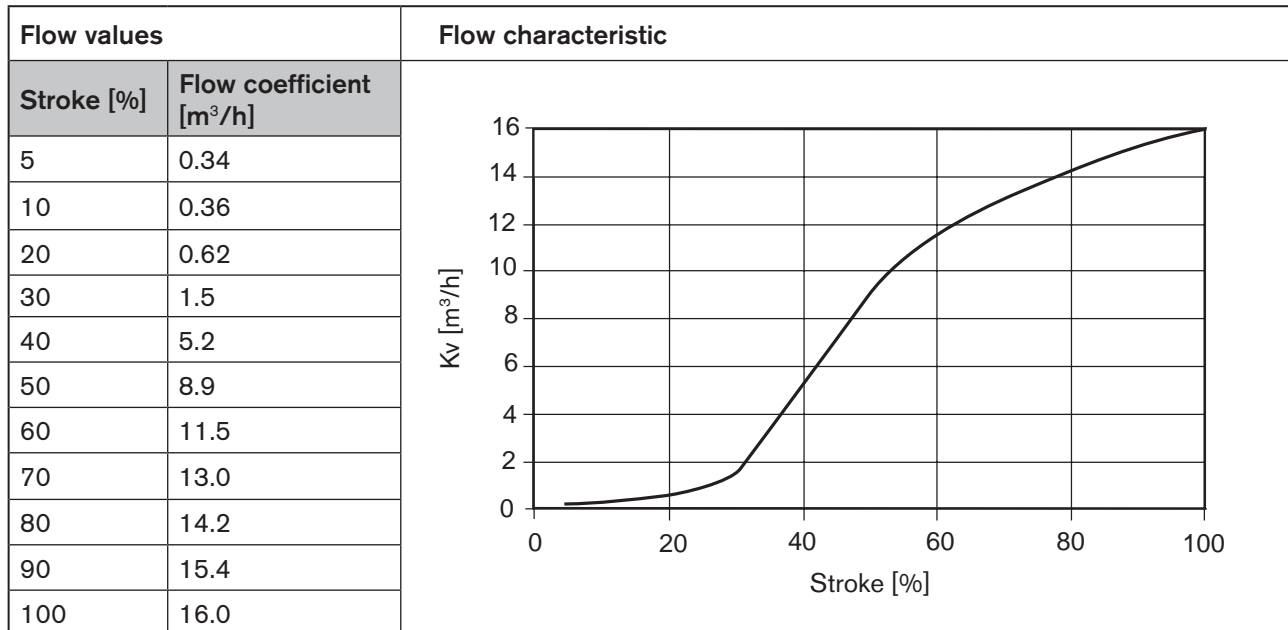

Table 14: Angle seat control valve, flow rate values and flow rate characteristic for seat size 25

### 8.8.4 Flow rate values and flow rate characteristic for seat size 32

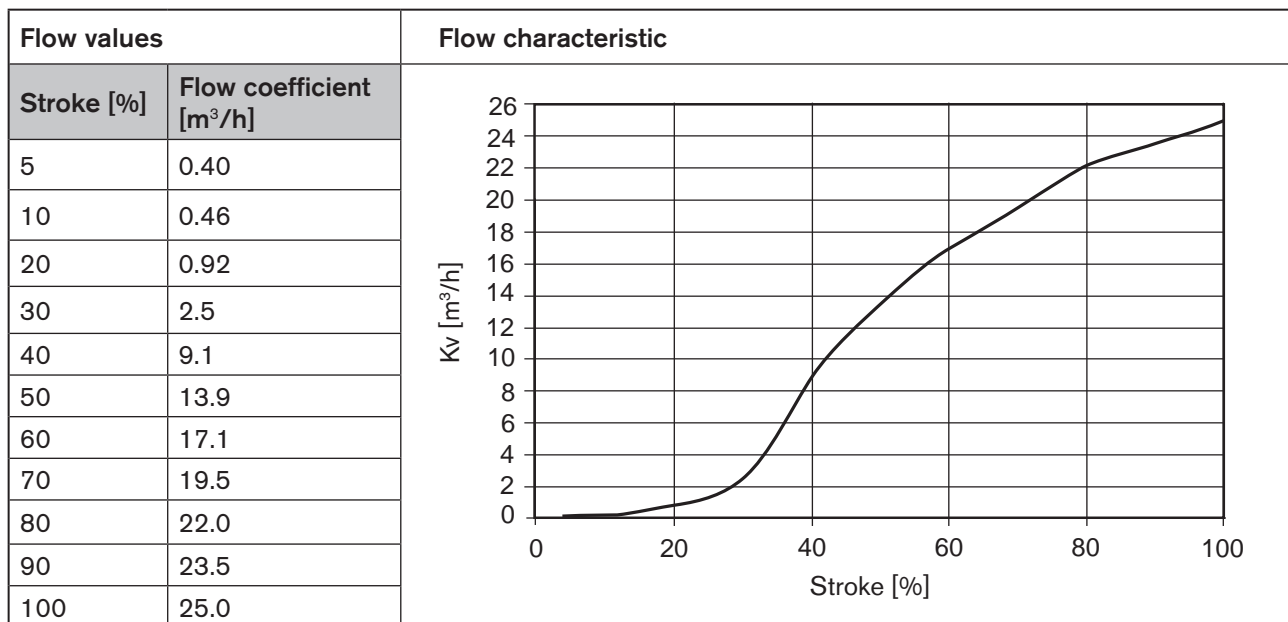

Table 15: Angle seat control valve, flow rate values and flow rate characteristic for seat size 32

### 8.8.5 Flow rate values and flow rate characteristic for seat size 40

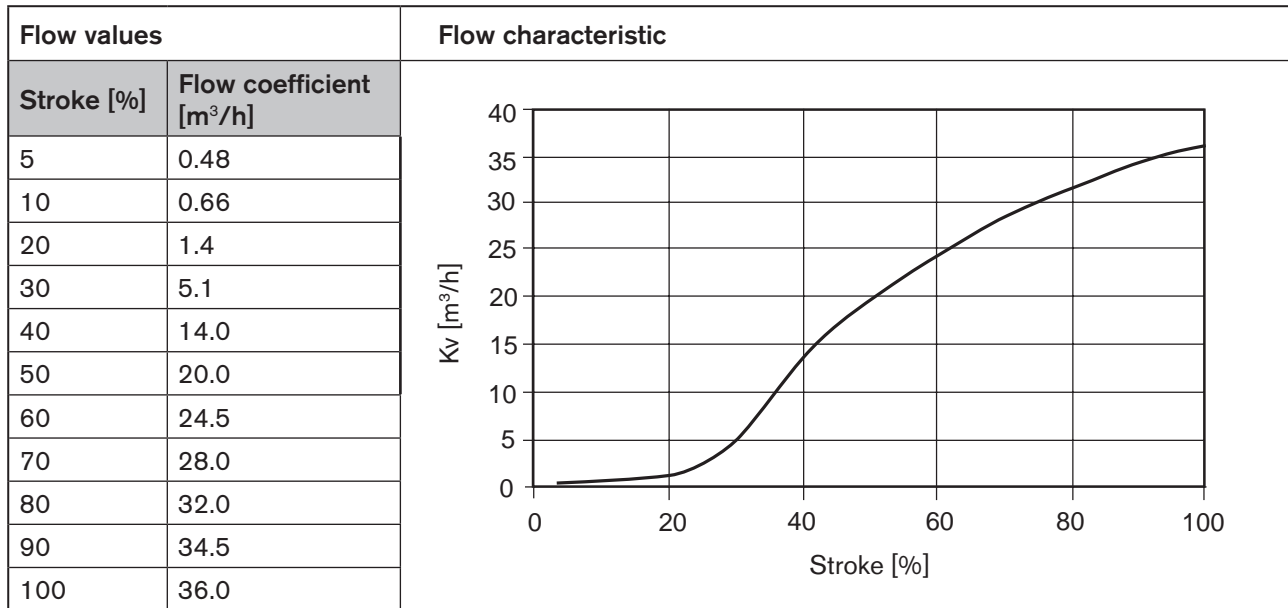

Table 16: Angle seat control valve, flow rate values and flow rate characteristic for seat size 40

### 8.8.6 Flow rate values and flow rate characteristic for seat size 50

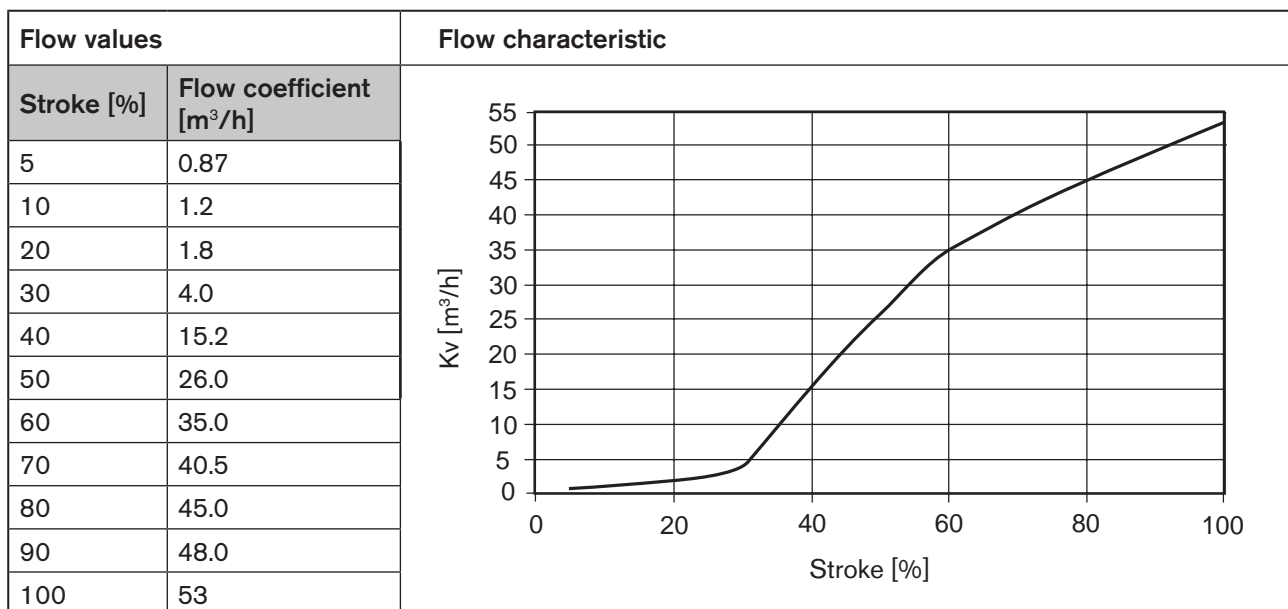

Table 17: Angle seat control valve, flow rate values and flow rate characteristic for seat size 50

## 8.9 Flow rate values and flow rate characteristics for globe control valve (Type 3361)

### 8.9.1 Flow rate characteristics

The globe control valve exhibits various characteristics depending on the valve seat size.

- Parabolic cone of equal per cent for valves with seat size 6–50
- Linear cone for valves with seat size 3–6
- Flow characteristic as per DIN EN 60534-2-4
- Theoretical rangeability ( $Kv_s: Kv_o$ )
 

Seat size 8–50:	50: 1
Seat size 6:	25: 1
Seat size 3–4:	10: 1
- $Kv_R$  value\* at 5% of the stroke for seat size > 10  
 $Kv$  value at 10% of the stroke for seat size ≤ 10

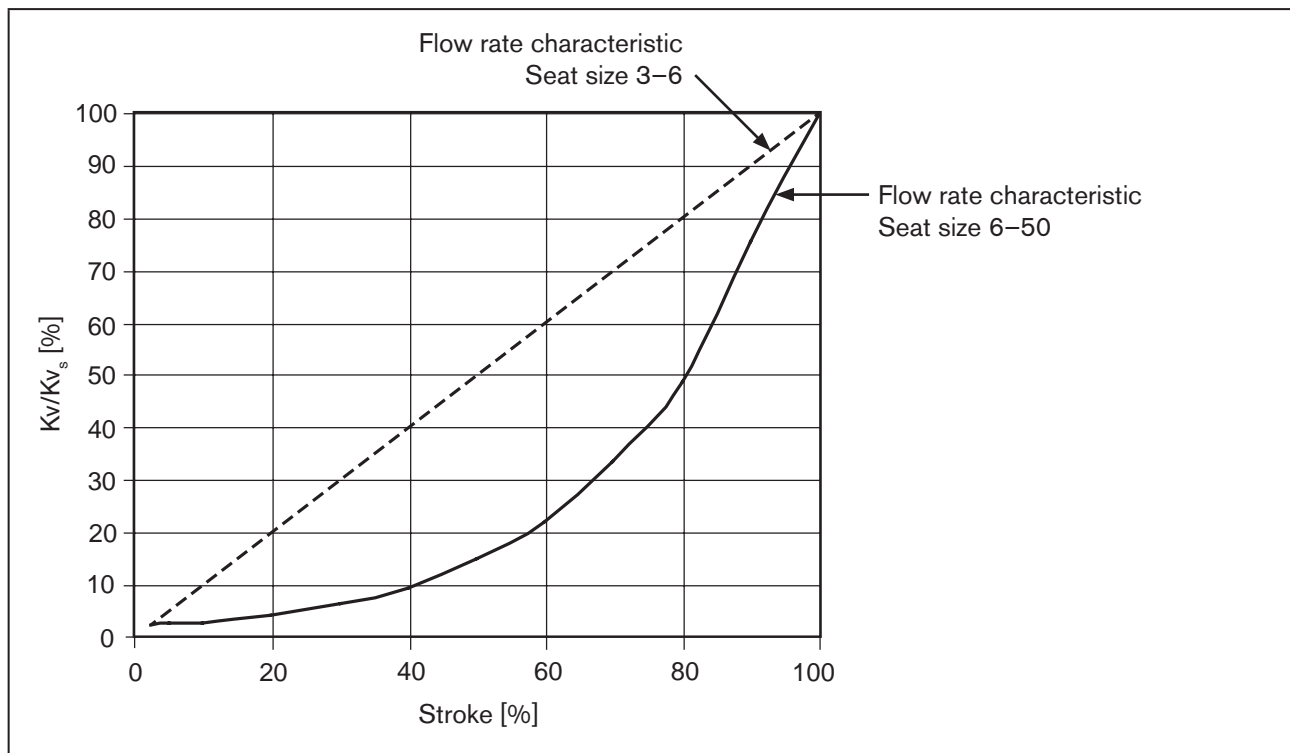

Image 12: Flow rate characteristic, globe control valves

\*  $Kv_R$  value = lowest  $Kv$  value at which the tilt tolerance as per DIN EN 60534-2-4 can still be observed.



## 8.9.2 Flow values

### Kv<sub>s</sub> values

DN connection (valve body)		Kv <sub>s</sub> values										
		Seat size valve										
DN	[NPS]	3	4	6	8	10	15	20	25	32	40	50
10	3/8	0.10	0.50	1.2	2.0	2.7	-	-	-	-	-	-
15	1/2	0.10	0.50	1.2	2.1	3.1	4.3	-	-	-	-	-
20	3/4		-	-	-	3.2	5.2	7.1	-	-	-	-
25	1		-	-	-	-	5.3	7.2	12.0	-	-	-
32	1 1/4		-	-	-	-	-	8.0	13.0	17.8	-	-
40	1 1/2		-	-	-	-	-	-	13.6	20.0	24.0	-
50	2		-	-	-	-	-	-	-	21.0	24.5	37.0

Table 18: Kv<sub>s</sub> values, globe control valves

### Kv values

DN connection (valve body)		Seat size valve	Kv values [m <sup>3</sup> /h]										
			Stroke [%]										
DN	[NPS]		5	10	20	30	40	50	60	70	80	90	100
10	3/8	3	-	0.003	0.007	0.015	0.025	0.037	0.052	0.065	0.078	0.090	0.10
		4	-	0.050	0.10	0.16	0.22	0.27	0.32	0.36	0.40	0.44	0.50
		6	-	0.12	0.32	0.48	0.62	0.76	0.88	0.98	1.1	1.1	1.2
		8	-	0.070	0.090	0.12	0.18	0.26	0.42	0.61	0.92	1.5	2.0
		10	-	0.11	0.13	0.19	0.30	0.48	0.73	1.00	1.6	2.3	2.7
15	1/2	3	-	0.003	0.007	0.015	0.025	0.037	0.052	0.065	0.078	0.090	0.10
		4	-	0.050	0.10	0.16	0.22	0.27	0.32	0.36	0.40	0.44	0.50
		6	-	0.12	0.32	0.48	0.62	0.76	0.88	0.98	1.1	1.1	1.2
		8	-	0.080	0.11	0.13	0.19	0.27	0.43	0.63	0.95	1.6	2.1
		10	-	0.11	0.15	0.19	0.31	0.49	0.75	1.1	1.7	2.5	3.1
20	3/4	15	0.14	0.17	0.22	0.35	0.52	0.80	1.2	1.8	2.7	3.7	4.3
		10	0.11	0.12	0.16	0.20	0.33	0.52	0.77	1.2	1.8	2.6	3.2
		15	0.14	0.17	0.22	0.35	0.52	0.80	1.2	1.8	2.9	4.0	5.2
25	1	20	0.20	0.25	0.30	0.45	0.70	1.1	1.6	2.4	3.5	5.2	7.1
		15	0.14	0.17	0.22	0.35	0.52	0.80	1.2	1.8	2.9	4.1	5.3
		20	0.20	0.25	0.31	0.47	0.70	1.1	1.6	2.5	3.8	5.4	7.2
32	1 1/4	25	0.35	0.38	0.65	1.00	1.5	2.2	3.4	5.1	7.0	9.4	12.0
		20	0.22	0.25	0.35	0.50	0.75	1.1	1.6	2.5	3.8	5.8	8.0
		25	0.40	0.47	0.73	1.1	1.6	2.5	3.7	5.4	7.5	10.3	13.0
		32	0.48	0.60	0.85	1.3	2.1	3.1	4.5	6.8	10.2	14.0	17.8

Table 19: Kv values, DN10 to DN32, globe control valves

DN connection (valve body)		Seat size valve	Kv values [m <sup>3</sup> /h]										
			Stroke [%]										
DN	[NPS]		5	10	20	30	40	50	60	70	80	90	100
40	1 1/2	25	0.40	0.50	0.75	1.1	1.7	2.6	3.8	5.6	8.0	10.7	13.6
		32	0.48	0.60	0.85	1.3	2.1	3.2	4.6	6.9	11.0	15.0	20.0
		40	0.60	0.70	1.1	1.7	2.7	4.0	6.0	9.2	13.8	18.2	24.0
50	2	32	0.48	0.60	0.90	1.3	2.1	3.2	4.6	6.9	11.6	16.0	21.0
		40	0.60	0.70	1.00	1.7	2.6	4.0	5.9	9.2	14.0	18.9	24.5
		50	0.90	1.1	1.9	2.9	4.5	6.8	10.5	15.5	22.0	29.0	37.0

Table 20: *Kv values, DN40 to DN50, globe control valves*

## 9 INSTALLING THE VALVE

### 9.1 Safety instructions



#### WARNING!

##### Risk of injury due to improper installation.

- ▶ Installation may be carried out by trained technicians only with the appropriate tools.
- ▶ Secure the system against unintentional activation.
- ▶ After installation, ensure that the process is restarted in a controlled manner. Observe the sequence!
  1. Connect supply voltage.
  2. Charge the device with medium.



#### CAUTION!

##### Risk of injury due to heavy device.

During transportation or installation work, the device may fall down and cause injuries.

- ▶ Transport, install and remove heavy device with the aid of a second person only.
- ▶ Use suitable tools.

### 9.2 Installation of devices with threaded connection, flange connection or clamp connection

#### NOTE!

##### Damage to valve body, valve seat seal or diaphragm.

- ▶ To prevent damage, the device must be in MANUAL operating state during installation.

Devices in their factory default state already have their operating state set to MANUAL.

#### 9.2.1 Required work steps

1. If not already preset, set MANUAL operating state, chapter [“14.1” on page 94](#).
2. If the device is already electrically connected, shut off supply voltage. Wait until LED illuminated ring goes out.
3. Install device in pipeline, chapter [“9.2.3” on page 44](#).
4. Electrical installation, chapter [“10” on page 53](#).
5. Connect supply voltage.
6. Set AUTOMATIC mode, chapter [“14.1” on page 94](#).

## 9.2.2 Mounting conditions

**Installation position:** arbitrary, ideally with actuator facing upwards.

**Flow direction:** indicated on the type label with an arrow and the digits 1 and 2.  
The 1 and 2 are also on the valve body for identification.  
The flow direction is below the seat with flow from port 2 to port 1.

**Pipelines:** ensure that pipelines are in alignment.

**Filter:** required for devices with approval as per EN 161.  
According to EN 161 "Automatic shut-off valves for gas burners and gas appliances", a dirt trap, which prevents the penetration of a 1 mm test pin, must be installed upstream of the valve in the pipeline.

**Preparation:** Clear impurities from pipelines (seal material, metal chips, etc.).

## 9.2.3 Install device in the pipeline

**Precondition:** MANUAL operating state.

### NOTE!

The following must be heeded when installing the device in the system.

The device and relief bore must be accessible for inspections and maintenance work.



### DANGER!

**Risk of injury from high pressure.**

- ▶ Before working on the system, switch off the pressure and vent or empty the lines.



### WARNING!

**Risk of crushing by mechanically powered parts.**

- ▶ Do not reach into the openings of the valve body.

→ Connect valve body to pipeline.



Ensure that there is no voltage present and minimal vibration during installation.



### Holding device

To protect the valve actuator from damage resulting from forces and vibrations, a holding device is recommended. This is available as an accessory. See chapter "[24 Accessories, replacement parts](#)".

### Next steps:

- Electrical installation, chapter "[10](#)" on page 53.
- Connect supply voltage.
- Set AUTOMATIC mode, chapter "[14.1](#)" on page 94.

## 9.3 Installation of devices with welded connections

### NOTE!

#### Damage to valve body, valve seat seal or diaphragm.

- ▶ To avoid damage, the valve should only be mounted in the opened valve position and in the MANUAL operating state.

Devices in their factory default state already have their operating state set to MANUAL.

### NOTE!

#### The following must be heeded when installing the device in the system.

The device and relief bore must be accessible for inspections and maintenance work.

### 9.3.1 Required work steps

The device must not be welded into the pipeline while the actuator is still installed. The installation is divided into the following steps:

1. If not already preset, set MANUAL operating state, chapter [“14.1” on page 94](#).
2. If the valve is in the closed position, switch the valve to the open position, chapter [“15” on page 105](#).
3. If the device is already electrically connected, shut off supply voltage. Wait until LED illuminated ring goes out.
4. Remove actuator from the valve body, chapter [“9.4” on page 46](#).
5. Weld the valve body into the pipeline, chapter [“9.3.4” on page 46](#).
6. Mount actuator on the valve body, chapter [“9.5” on page 49](#).
7. Electrical connection of the device, chapter [“10” on page 53](#).
8. Connect supply voltage.
9. To adjust the position control, execute the X.TUNE function, chapter [“11.6” on page 68](#).
10. Set AUTOMATIC mode, chapter [“14.1” on page 94](#).

### 9.3.2 Required tool

- Allen key, width across flats 3 mm  
Required when no supply voltage is applied to the device in order to move the valve into the open position.
- Open-end wrench

### 9.3.3 Mounting conditions

**Installation position:** any

**Flow direction:** indicated on the type label with an arrow and the digits 1 and 2.  
The 1 and 2 are also on the valve body for identification.  
The flow direction is below the seat with flow from port 2 to port 1.

**Pipelines:** ensure that pipelines are in alignment.

**Filter:** required for devices with approval as per EN 161.  
According to EN 161 “Automatic shut-off valves for gas burners and gas appliances”, a dirt trap, which prevents the penetration of a 1 mm test pin, must be installed upstream of the valve in the pipeline.

**Preparation:** Clear impurities from pipelines (seal material, metal chips, etc.).

### 9.3.4 Weld the valve body into the pipeline

#### **DANGER!**

**Risk of injury from high pressure.**

- ▶ Before working on the system, switch off the pressure and vent or empty the lines.

#### **NOTE!**

**The electronics assembly in the actuator will be damaged by the effects of heat.**

- The actuator must be removed before the valve body is welded in.

→ Weld the valve body into the pipeline.

-  Ensure that there is no voltage present and minimal vibration during installation.



#### **Holding device**

To protect the valve actuator from damage resulting from forces and vibrations, a holding device is recommended. This is available as an accessory. See chapter [“24 Accessories, replacement parts”](#).

#### **Next steps:**

- Mount actuator on the valve body, chapter [“9.5” on page 49](#).
- Electrical connection of the device, chapter [“10” on page 53](#).
- Connect supply voltage.
- To adjust the position control, execute the X.TUNE function, chapter [“11.6” on page 68](#).

#### **NOTE!**

**Damage to valve body, valve seat seal or diaphragm.**

- ▶ To prevent damage, execute the X.TUNE function first after establishing the electrical connection. Only then should the operating state be set to AUTOMATIC.

- Set AUTOMATIC mode, chapter [“14.1” on page 94](#).

## 9.4 Disassembly of the actuator from the valve body

#### **DANGER!**

**Risk of injury from high pressure.**

- ▶ Before working on the system or device, switch off the pressure and vent or empty the lines.

#### **WARNING!**

**Risk of injury due to improper installation work.**

- ▶ The actuator may be removed only by trained technicians and with the appropriate tools.

### 9.4.1 Required work steps

1. Set MANUAL operating state, chapter [“14.1”](#) on page 94.
2. Move valve into open position, chapter [“15”](#) on page 105.
3. Switch off the supply voltage. Wait until LED illuminated ring goes out.
4. Remove actuator from the valve body, chapter [“9.4.3”](#) on page 47.

### 9.4.2 Required tool

- Allen key, width across flats 3 mm  
Only required when no supply voltage is applied to the device in order to move the valve into the open position.
- Open-end wrench

### 9.4.3 Remove the actuator from the valve body

**Preconditions:**

MANUAL operating state, valve position at least 1/3 open, supply voltage switched off.

**WARNING!**

Risk of injury due to electric shock.

Risk of crushing by mechanically powered parts.

- ▶ Switch off the supply voltage.
- ▶ For devices with SAFEPOS energy-packs: Ensure that the SAFEPOS energy-pack is fully discharged. Wait until the LED ring is no longer lit and ensure that the LED status indicator is not in **“LED off”** mode.

**NOTE!**

Damage to valve body or valve seat seal.

To avoid damage, the valve must be open when the actuator is disassembled.

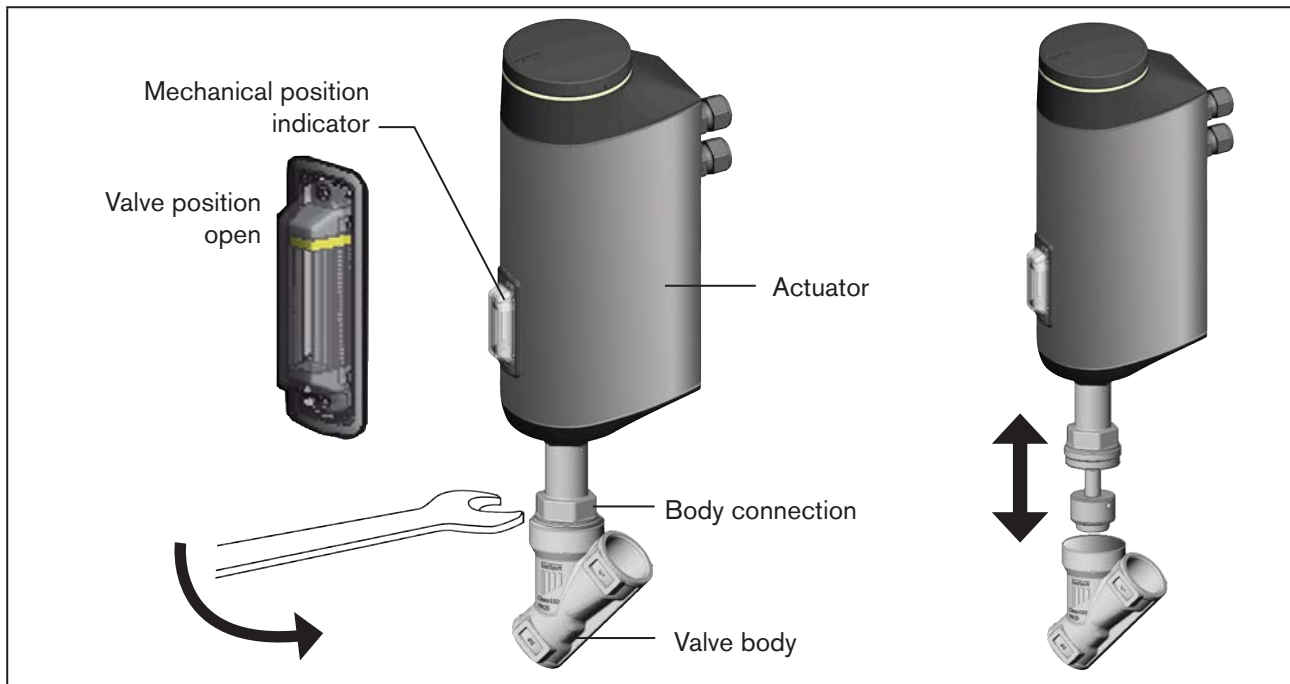

Image 13: Actuator disassembly (with angle seat control valve as an example)

- Clamp valve body into a holding device.
- Place on the body connection with a suitable open-end wrench.  
⚠ Do not use any tools for unscrewing which could damage the body connection.
- Unscrew actuator from the valve body.



## 9.5 Installing actuator on valve body

### Preconditions:

**MANUAL** operating state, valve position at least 1/3 open, supply voltage switched off.

→ ⚠ Before installing the actuator, check whether the graphite seal for the valve body is present and undamaged.

→ Replace damaged or missing graphite seal.

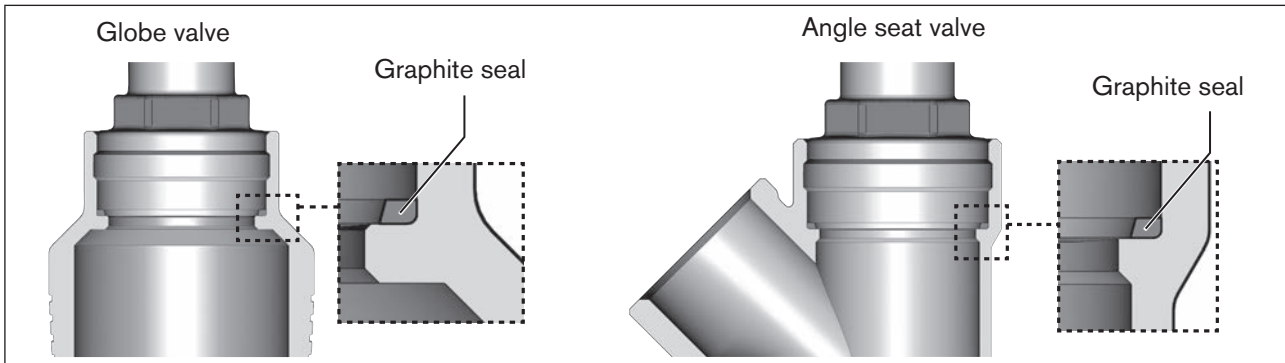

Image 14: Graphite seal

### NOTE!

**Damage to valve body or valve seat seal.**

To avoid damage, the valve must be in an open position when the actuator is disassembled.



### WARNING!

**Danger due to unsuitable lubricants.**

Unsuitable lubricant may contaminate the medium. There is a risk of explosion in oxygen applications.

► For specific applications, e.g. oxygen or analysis applications, use approved lubricants only.

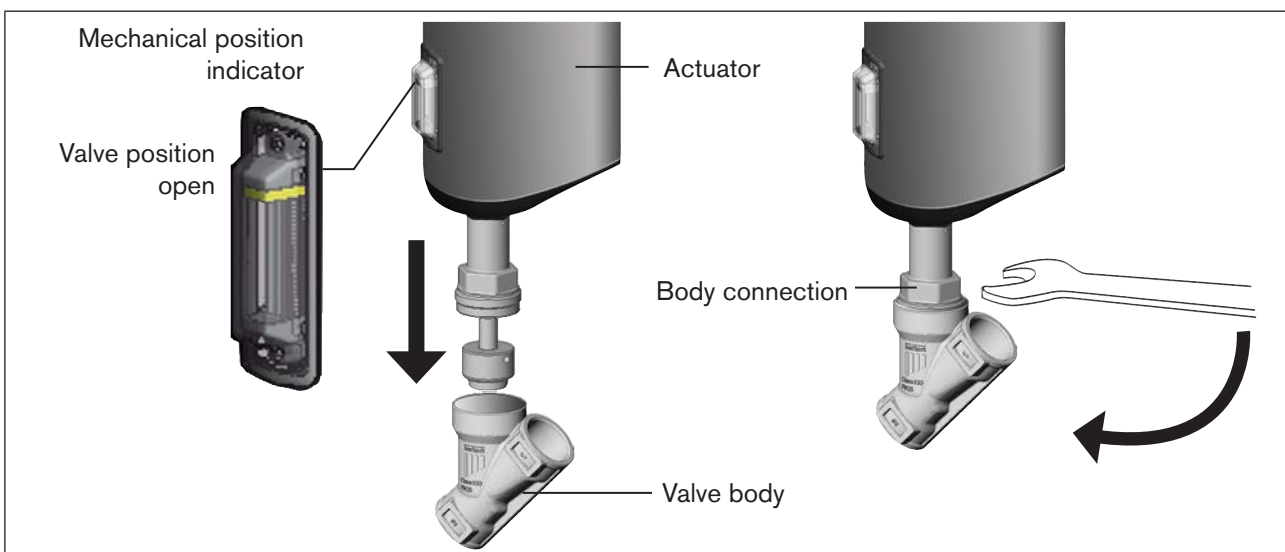

Image 15: Installing actuator on valve body

- Before re-installation, grease the external thread of the body connection (e.g. with Klüberpaste UH1 96-402 from Klüber).
- Position the external thread of the valve body on the internal thread of the body connection.
- Place on the body connection with a suitable open-end wrench.
- ⚠ Do not use any tools for unscrewing, which could damage the body connection.



**WARNING!**

**Risk of injury when failing to observe tightening torque value!**

Failure to observe the tightening torque value is dangerous due to the risk of damage to the device.

- ▶ Observe the tightening torque value.

- Screw actuator onto valve body.
- ⚠ Observe tightening torque (see "Table 21").

DN connection (valve body) [DN]	Tightening torque for body connection [Nm]
10/15	45 ± 3
20	50 ± 3
25	60 ± 3
32	65 ± 3
40	
50	70 ± 3
65	100 ± 3
80	120 ± 5
100	150 ± 5

Table 21: Tightening torque for body connection

**Next steps:**

- Electrical connection of the device, chapter "10" on page 53.  
The position of the ports can be changed by turning the actuator through 360°. For a description see chapter "9.6 Rotating the actuator".
- Connect supply voltage.
- To adjust the position control, execute the X.TUNE function, chapter "11.6" on page 68.

**NOTE!**

**Damage to valve body, valve seat seal or diaphragm.**

- ▶ To prevent damage, execute the X.TUNE function first after establishing the electrical connection. Only then should the operating state be set to AUTOMATIC.

- Set AUTOMATIC mode, chapter "14.1" on page 94.

## 9.6 Rotating the actuator

The position of the ports can be changed by turning the actuator through 360°.

### NOTE!

#### Damage to the valve seat seal and valve seat contour when valve closed.

If the valve is closed when the actuator is turned, the valve seat seal and the valve seat contour can be damaged.

- If the valve is closed: Before turning the actuator, open the valve with the mechanical manual override. For a description see [“15.4 Actuating the valve mechanically”](#).

→ For devices that have not been installed, clamp the valve body in a holding device.

→ Place a suitable open-end wrench (width across flats M41) on the hexagon head of the actuator.

→ Move the actuator into the desired position preferably by turning it clockwise.

If only turning counterclockwise is technically possible for installation, observe the following safety warning:



### WARNING!

#### Risk of injury from discharge of pressure and escaping medium.

If the actuator is turned counterclockwise, the body connection can loosen.

- ▶ When turning counterclockwise, hold a second open-end wrench against the hexagon of the body connection.

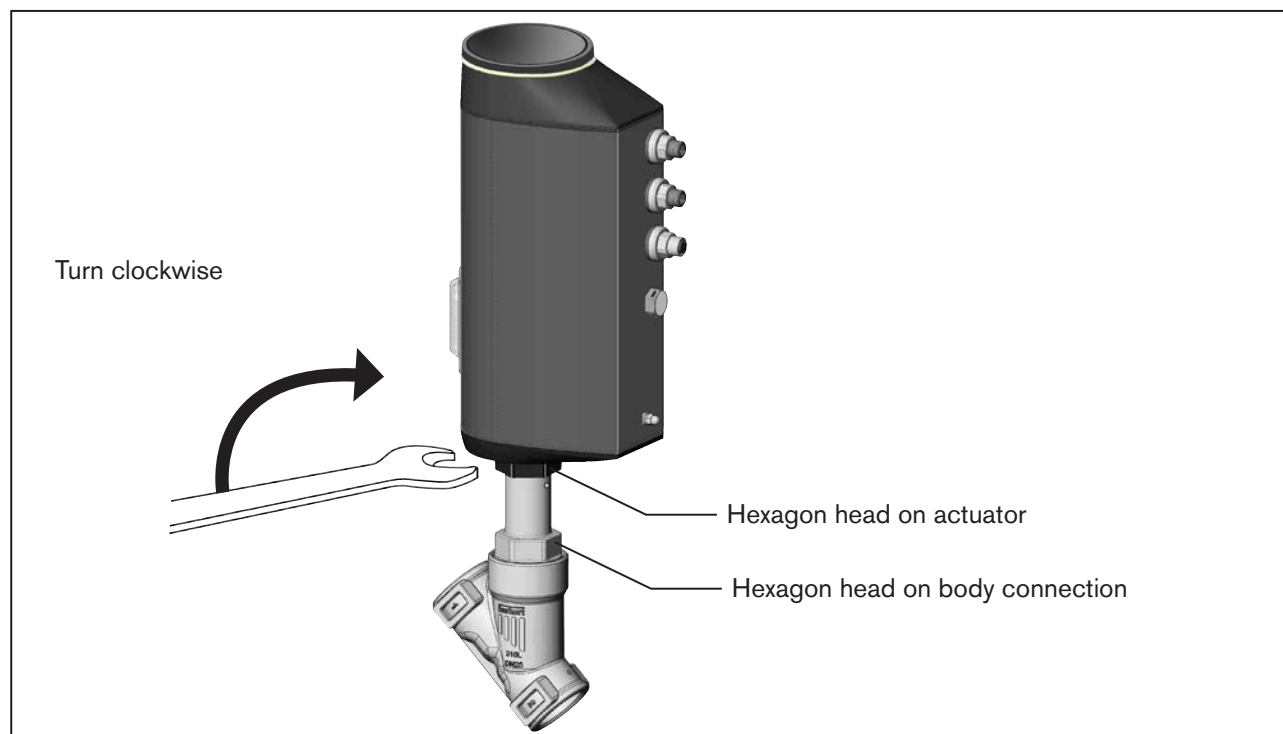

Image 16: Turning actuator

## 9.7 Holding device

The holding device protects the valve actuator from damage resulting from forces and vibrations. The holding device is available as an accessory in 2 sizes. See chapter [“24 Accessories, replacement parts”](#) on page 152.

### 9.7.1 Mounting the holding device

→ Attach the holding device to the pipe between the valve body and the actuator as shown in the picture.

In case of existing relief bore:

#### **NOTE!**

Make sure that the relief bore, which is used to detect leaks, is not covered.

→ Fix the holding device in place by suitable means.

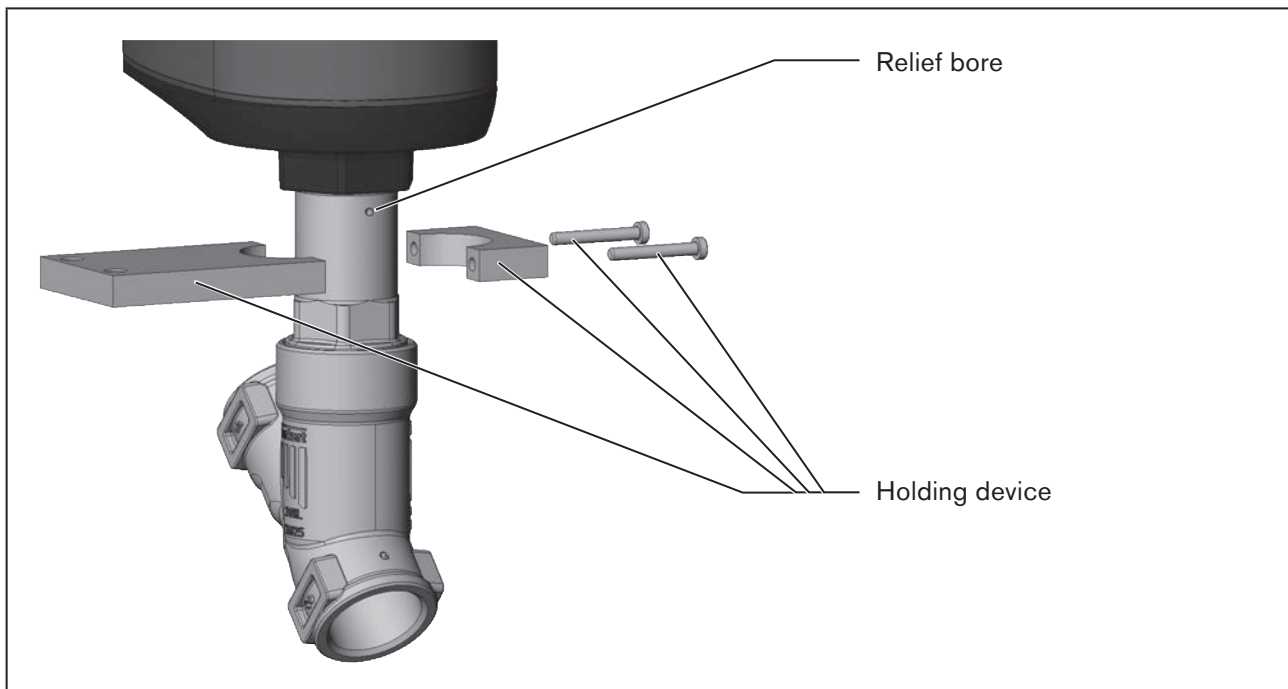

Image 17: Mounting the holding device

## 10 ELECTRICAL INSTALLATION

The electromotive control valve is available with two connector options:

- With a circular plug-in connector (multi-pin variant)
- Cable gland with connection terminals

### Signal values

Operating voltage:	24 V 
Set-point value:	0–20 mA; 4–20 mA 0–5 V; 0–10 V

### 10.1 Electrical installation with circular plug-in connector

#### 10.1.1 Safety instructions

#### **WARNING!**

##### Risk of injury due to improper installation.

- ▶ Installation may be carried out by authorised technicians only and with the appropriate tools.
- ▶ Observe general engineering standards & rules during installation.

##### Risk of injury due to unintentional activation of the system and uncontrolled restart.

- ▶ Secure the system against unintentional activation.
- ▶ Following installation, ensure a controlled restart.

#### **NOTE!**

To ensure electromagnetic compatibility (EMC) the functional earth must be connected to earth with a short line (max. 1 m). The functional earth must have a cross-section of at least 1.5 mm<sup>2</sup>.

#### **Use of set-point input 4–20 mA**

If several Type 3360 or 3361 devices are connected in series and the electrical power supply for a device in this connected series fails, the input of the failed device becomes highly resistive. As a result, the 4–20 mA standard signal fails.

##### **Choice of connection line:**

When choosing the length and cross-section of the individual wires, take into account the voltage drop in relation to the maximum supply current.

→ Connect the device in accordance with the tables.

→ Perform the necessary basic configuration and adjustments for the electromotive control valve after the operating voltage has been established. For a description see chapter "[11 Start-up](#)".

### 10.1.2 Description of circular plug-in connectors

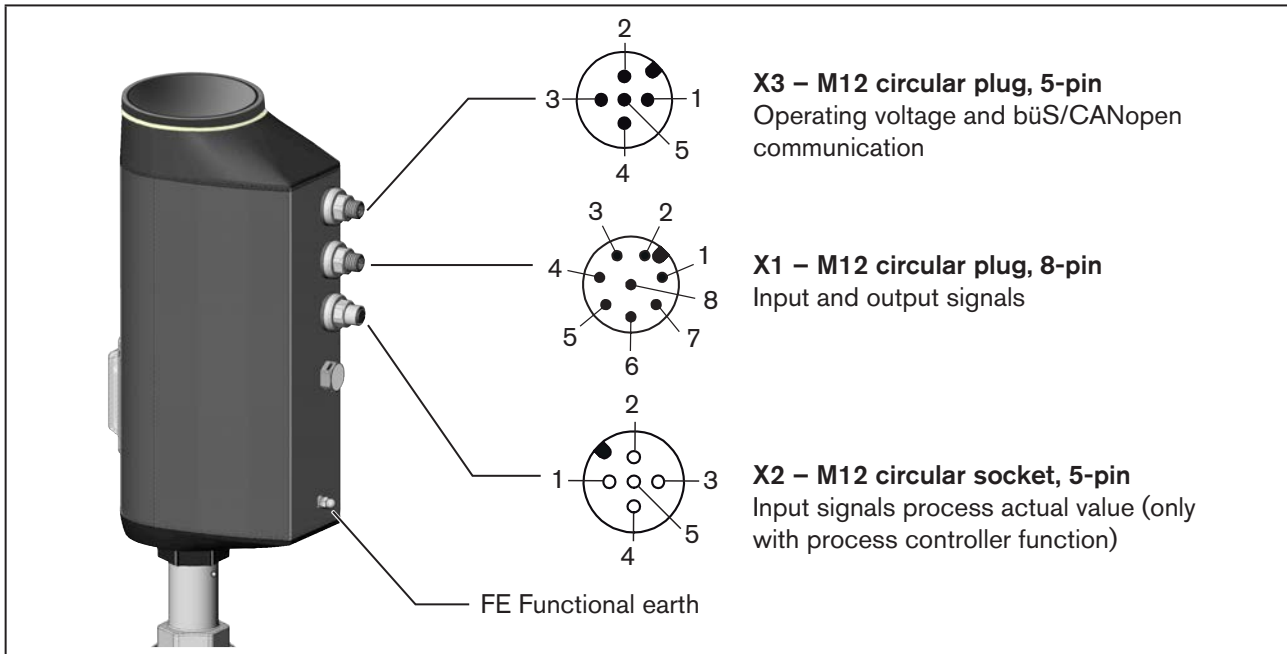

Image 18: Description of circular plug-in connectors

### 10.1.3 X1 – M12 circular plug, 8-pin, Input and output signals

Pin	Wire colour*	Assignment (device side)
<b>Input signals from control centre (e.g. PLC)</b>		
8	red	Set-point value + (0/4–20 mA or 0–5/10 V) for operating voltage electrically isolated
7	Blue	Set-point value –
1	white	Digital input + $\begin{cases} 0...5 \text{ V (log. 0)} \\ 10...30 \text{ V (log. 1)} \end{cases}$
<b>Output signals to control centre (e.g. PLC) only required with analogue output and/or digital output option</b>		
6	Pink	Analogue output+ (0/4–20 mA or 0–5/10 V)
5	grey	Analogue output –
4	yellow	Digital output 1 (24 V / 0 V)
3	green	Digital output 2 (24 V / 0 V)
2	brown	Digital inputs and digital outputs GND
* The specified wire colours refer to the connection cable, which is available as an accessory with ID no. 919061.		

Table 22: X1 – M12 circular plug, 8-pin

### 10.1.4 X2 – M12 circular socket, 5-pin input signals process actual value (only with process control function)

Signal type*	Pin	Wire colour**	Assignment	Device end	External circuit
4–20 mA – internally supplied	1 2 3 4 5	brown white Blue Black grey	+24 V supply transmitter PV1: not used GND (identical to GND operating voltage) PV2: output from transmitter PV3: Bridge to GND (GND from 3-wire transmitter)	1 2 3 4 5	
4–20 mA – externally supplied	1 2 3 4 5	brown white Blue Black grey	not used not used not used PV2: Process actual + PV3: Process actual -	4 5	
Frequency – internally supplied	1 2 3 4 5	brown white Blue Black grey	+24 V supply sensor PV1: Cycle input + GND PV2: not used PV3: Bridge to GND (GND from 3-wire transmitter)	1 2 3 5	
Frequency – externally supplied	1 2 3 4 5	brown white Blue Black grey	not used PV1: Cycle input + not used PV2: not used PV3: Cycle input -	2 5	
Pt 100 (see note below)	1 2 3 4 5	brown white Blue Black grey	not used PV1: Process actual 1 (power supply) not used PV2: Process actual 2 (compensation) PV3: Process actual 3 GND	2 4 5	
<p>*Configurable in the software:  <b>Inputs/outputs</b> → PV → ANALOG.type (signal source: PV.source → Analogue).</p> <p>** The specified wire colours relate to the 5-pin M12 connection cable, which is available as an accessory with ID no. 559177.</p>					

Table 23: X2 – M12 socket, 5-pin, input signals process actual value (only on devices with process control function)



#### NOTE!

The Pt 100 sensor must be connected via three lines to compensate for line resistance.  
 Pin 4 and Pin 5 must be bridged at the sensor.  
 Connection cables must not exceed 20 m in length.

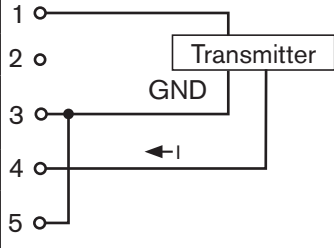
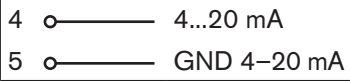
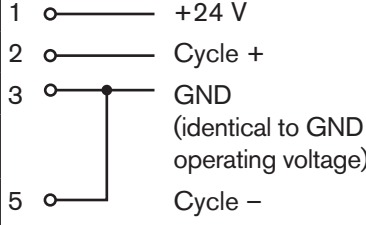
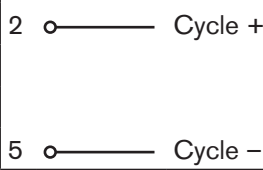
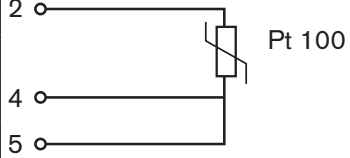
### 10.1.5 X3 – M12 circular plug, 4-pin or 5-pin, operating voltage and büS/CANopen communication

Pin	Wire colour		Assignment (device side)
	without büS/CANopen network 4-pin connection*	with büS/CANopen network**	
1	- (connection not required)	CAN Shield	
2	white	red	+24 V $\pm 10\%$ max. residual ripple 10 %
3	blue	black	GND / CAN_GND
4	- (connection not required)	white	CAN_H
5	- (not available with 4-pin socket)	blue	CAN_L

\* The specified wire colours relate to the 4-pin M12 connection cable, which is available as an accessory with ID no. 918038.

\*\* The specified wire colours relate to the büS cable, which is available as an accessory. See „Cabling Guide for büS/EDIP“ at [country.burkert.com](http://country.burkert.com)

Table 24: X3 – M12 circular plug, 5-pin, operating voltage and büS/CANopen communication



**Electrical installation with or without büS/CANopen network:**

To use the büS/CANopen network (CAN interface), a shielded 5-wire cable with a 5-pin socket must be used.

If the büS/CANopen network is not used, only the operating voltage must be connected and a 4-wire cable with a 4-pin socket can be used



Additional information about cabling for büS networks is available at manual „Cabling Guide for büS/EDIP“ at [country.burkert.com](http://country.burkert.com)

→ Perform the necessary basic setting and adjustments for the electromotive control valve after the operating voltage has been established. For description see chapter “11.4 Base settings”.



## 10.2 Electrical connection Fieldbus gateway



Image 19: Electrical connection Fieldbus gateway

The fieldbus connection is made with a circular plug-in connector M12, 4-pin.

Connection diagram Socket (device side)	Pin	Assignment (device side)
	1	Transmit +
	2	Receive +
	3	Transmit -
	4	Receive -

Table 25: Electrical assignment of fieldbus gateway

### NOTE!

To ensure electromagnetic compatibility (EMC), a shielded Ethernet cable must be used. Connect the cable shielding on both sides to earth (i.e. on each of the connected devices).

The metal housing of the M12 circular plug-in connector is connected to the actuator housing, which is why the functional earth must be connected to earth on the actuator housing. Use a short line (max. 1 m) with a cross-section of at least 1.5 mm<sup>2</sup> for connecting to earth.

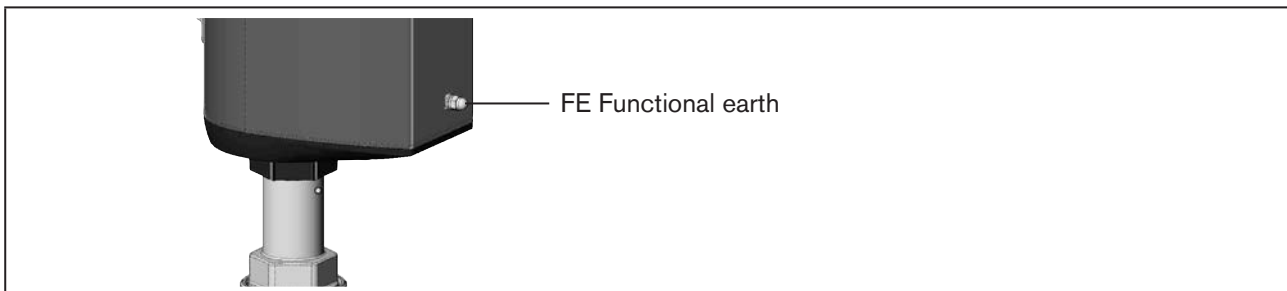

Image 20: Functional earth

## 10.3 Electrical installation with cable gland

### 10.3.1 Safety instructions



#### **WARNING!**

##### **Risk of injury due to improper installation.**

- ▶ Installation may be carried out by authorised technicians only and with the appropriate tools.
- ▶ Observe general engineering standards & rules during installation.

##### **Risk of injury due to unintentional activation of the system and uncontrolled restart.**

- ▶ Secure the system against unintentional activation.
- ▶ Following installation, ensure a controlled restart.



#### **Use of set-point input 4–20 mA**

If several Type 3360 or 3361 devices are connected in series and the electrical power supply for a device in this connected series fails, the input of the failed device becomes highly resistive. As a result, the 4–20 mA standard signal fails.

#### **NOTE!**

To ensure electromagnetic compatibility (EMC) the functional earth must be connected to earth with a short line (max. 1 m). The functional earth must have a cross-section of at least 1.5 mm<sup>2</sup>.

### 10.3.2 Access to connection terminals



#### **Devices with ATEX approval or IECEx approval are secured with a magnetic lock.**

The removal of the cover is described in the supplementary instructions for the electromotive control valves with ATEX approval and IECEx approval.

To access the terminals, open the actuator housing as described below.

#### **1. Remove display module or blind cover:**

#### **NOTE!**

Carefully remove the display module so that the connection cable and HMI interface are not damaged.



Image 21: Remove blind cover or display module

→ To unlock, turn the display module or the blind cover counterclockwise and remove.

**NOTE!** For devices with display module, take note of the connection cable to the HMI interface.

→ For devices with display module, disconnect the connection cable from the HMI interface.

## 2. Remove the LED and storage module:

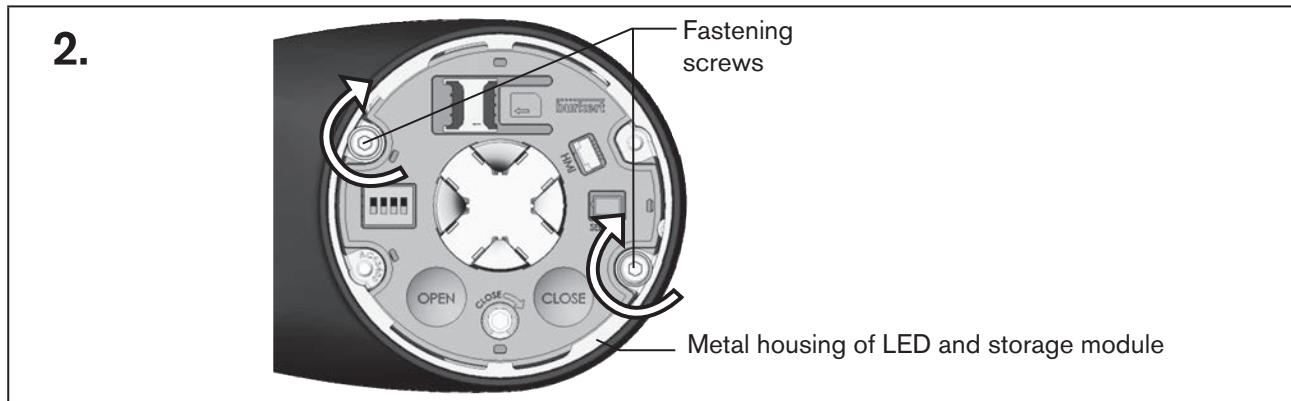

Image 22: Remove the LED and storage module

→ Remove 2 fastening screws (hexalobular-internal screws T20).

→ Grab the LED and storage module by both sides of the metal housing and lift it out.

## 3. Remove the actuator cover:

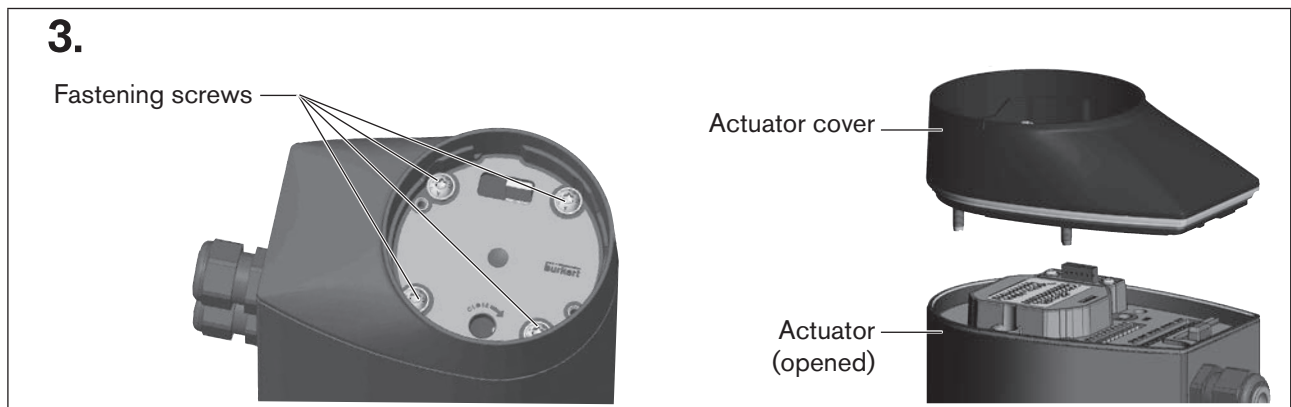

Image 23: Removing actuator cover

→ Remove 4 fastening screws (hexalobular-internal screws T25).

The screws are integrated securely in the actuator cover.

→ Remove the actuator cover.

The connection terminals are now accessible.

### 10.3.3 Connecting the cable

→ Push the cable through the cable gland.

#### NOTE!

**Take note for connection to spring-loaded terminals.**

- ▶ Minimum length of wire ferrules: 8 mm
- ▶ Maximum cross-section of wire ferrules: 1.5 mm<sup>2</sup> (uncollared), 0.75 mm<sup>2</sup> (collared)

→ Strip at least 8 mm of insulation from the wires and crimp ferrules on.

→ Attach the wires to the terminals. The terminal layout is provided in the tables below from [Page 61](#).

→ Tighten union nut of cable gland (tightening torque approx. 1.5 Nm).

#### NOTE!

**The ingress of dirt or moisture may cause damage or malfunction.**

To preserve IP65 and IP67 protection, ensure the following:

- ▶ Unused cable glands must be sealed using dummy plugs.
- ▶ The union nuts of cable glands must be tightened. Tightening torque, dependent on the cable size or dummy plugs, approx. 1.5 Nm.

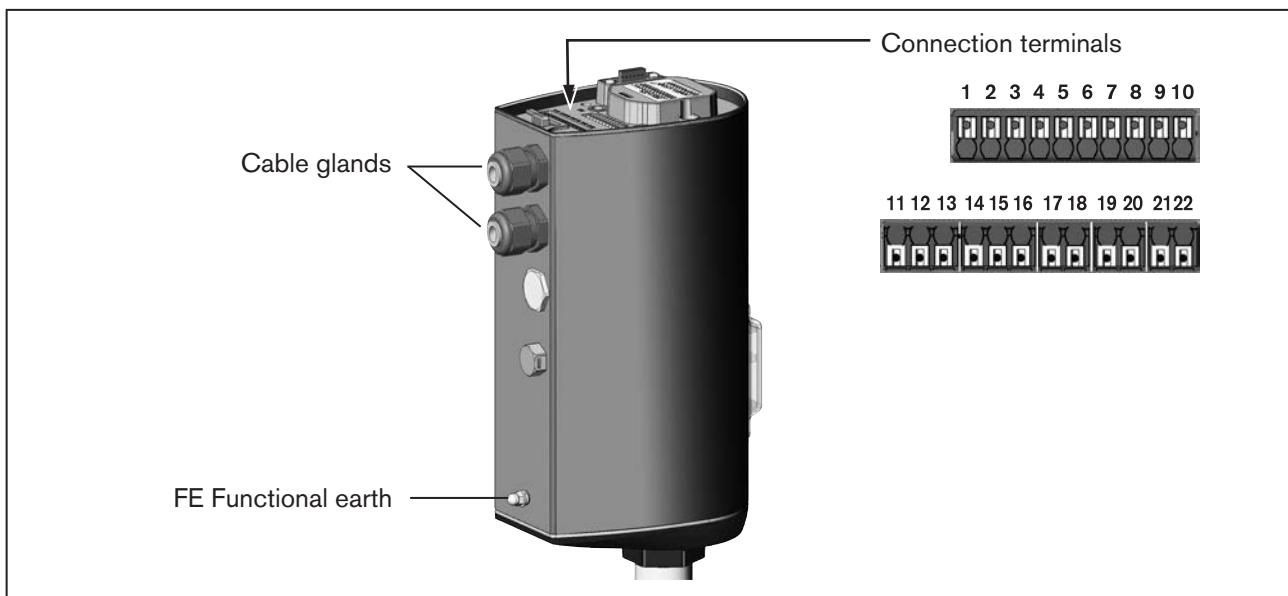

Image 24: Connecting the cable

→ Connect the device in accordance with the tables.

### 10.3.4 Terminal layout – input signal from control centre (e.g. PLC)

Clip	Assignment
8	Set-point value + (0/4–20 mA or 0–5/10 V) for operating voltage electrically isolated
7	Set-point value –
5	Digital input + 
4	Digital input GND relates to GND operating voltage (GND Clip)

Table 26: Terminal layout – input signal from control centre (e.g. PLC)

### 10.3.5 Terminal layout – output signals to control centre (e.g. PLC) – only required with analogue output and/or digital output option

Clip	Assignment
19	Analogue output + (0/4–20 mA or 0–5/10 V)
20	Analogue output –
18	Digital output 1 (24 V / 0 V)
17	Digital output 2 (24 V / 0 V)
16	Digital output GND

Table 27: Terminal layout – output signal to control centre (e.g. PLC)

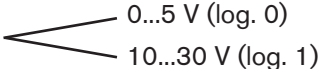
### 10.3.6 Terminal layout – operating voltage and bÜS network



Clip	Assignment
	CAN shield
10	24 V  ± 10% max. residual ripple 10%
9	GND
1*	CAN_GND  Only connect when a separate line is used for CAN.
2*	CAN_H
3*	CAN_L

Table 28: Terminal layout – operating voltage and bÜS network



\* Electrical installation of the bÜS network:

Terminals 1, 2 and 3 (CAN interface) are for the bÜS network connection.

Terminal 1 is bridged internally with terminal 9, however it is not designed for the operating voltage.

### 10.3.7 Terminal layout – process actual value input (only with process control function)

Signal type*	Clip	Assignment	Device end	External circuit
4–20 mA – internally supplied	22 15 21 14 13	+24 V supply transmitter PV1: not used GND (identical to GND operating voltage) PV2: output from transmitter PV3: Bridge to GND (GND from 3-wire transmitter)	22 15 21 14 13	
4–20 mA – externally supplied	22 15 21 14 13	not used not used not used PV2: Process actual + PV3: Process actual -	14 13	4...20 mA GND 4–20 mA
Frequency – internally supplied	22 15 21 14 13	+24 V supply sensor PV1: Cycle input + GND PV2: not used PV3: Bridge to GND (GND from 3-wire transmitter)	22 15 21 13	+24 V Cycle + GND (identical to GND operating voltage) Cycle -
Frequency – externally supplied	22 15 21 14 13	not used PV1: Cycle input + not used PV2: not used PV3: Cycle input -	15 13	Cycle + Cycle -
Pt 100 (see note below)	22 15 21 14 13	not used PV1: Process actual 1 (power supply) not used PV2: Process actual 2 (compensation) PV3: Process actual 3 GND	15 14 13	
*Configurable in the software: <b>Inputs/outputs</b> → PV → ANALOG.type (signal source: PV.source → Analogue).				

Table 29: Terminal layout – process actual value input (only on devices with process control function)



**NOTE!**

The Pt 100 sensor must be connected via three lines to compensate for line resistance. Clip 14 and clip 13 must be bridged at the sensor.

Connection cables must not exceed 20 m in length.

### 10.3.8 Close device

#### NOTE!

The ingress of dirt or moisture may cause damage or malfunction.

To preserve IP65 and IP67 protection, ensure the following before closing the device:

- ▶ The seal in the actuator housing/actuator cover must be inserted and undamaged.
- ▶ The seal surfaces must be clean and dry.

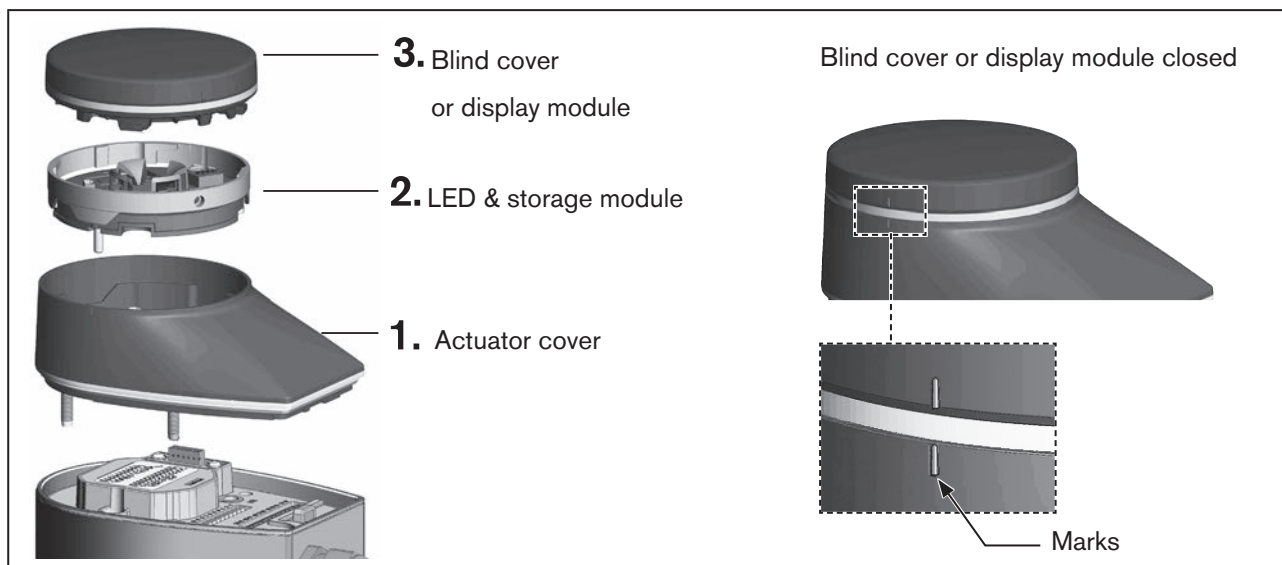

Image 25: Close device

#### 1. Mounting actuator cover

→ Place actuator cover on the actuator housing.

→ First screw in the four fastening screws (hexalobular-internal screws T25) by hand lightly, then tighten them (tightening torque: 5.0 Nm).

## 2. Mount LED and storage module:

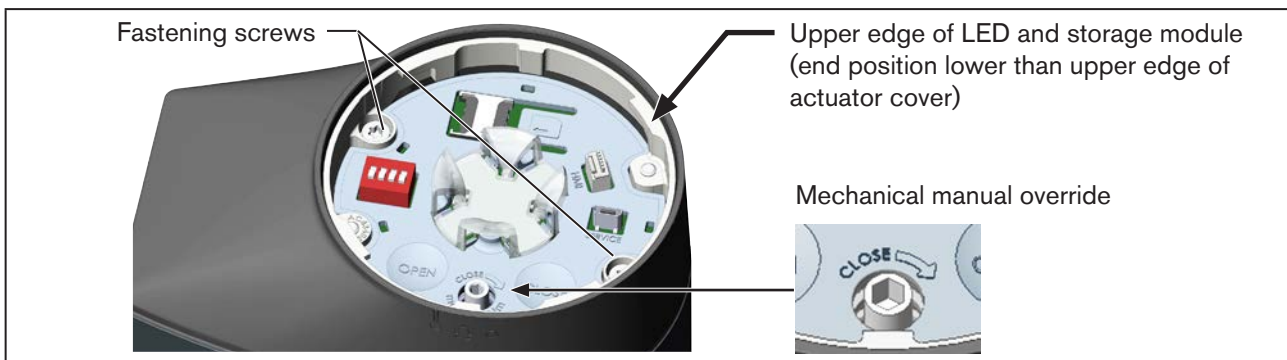

Image 26: Mount LED and storage module:

- Place the LED and storage module onto the actuator cover.  
Align the recess for the manual override in the centre, paying attention to the correct alignment of the electrical plug connection.
- Carefully press down the LED and storage module by hand.  
The end position is reached if the upper edge of the module is fully and evenly recessed in the actuator cover.

### NOTE!

**The plug connection will be damaged if the LED and storage module is not correctly inserted.**

- ▶ Before the fastening screws are tightened, the LED and storage module must be fully recessed in the actuator cover.

- Tighten 2 fastening screws (hexalobular-internal screws T20).  
Observe the tightening torque of 1.1 Nm!

## 3. Close device with blind cover or display module

For devices with display module:

- Connect the connection cable to the HMI interface.
- Fit the display module and turn clockwise until the marking at the edge is directly over the marking for the actuator cover.

For devices with blind covers:

Fit the blind cover and turn clockwise until the marking at the edge is directly over the marking for the actuator cover.

Perform the necessary basic configuration and adjustments for the electromotive control valve after the operating voltage has been established. For a description see chapter [“11.4 Base settings”](#).



# 11 START-UP

## 11.1 Safety instructions



### WARNING!

#### Risk of injury due to improper operation.

Improper operation may result in injuries as well as damage to the device and the surrounding area.

- ▶ The operating personnel must know and understand the contents of the operating instructions.
- ▶ The safety instructions and the intended use must be observed.
- ▶ Only adequately trained personnel may start up the system/device.

## 11.2 Before start-up

### NOTE!

#### Consider for devices requiring disassembly for installation.

If the actuator is disassembled, X.TUNE function must be carried out again before start-up. See chapter [“11.6 Adjustment of position controller – execute X.TUNE”](#).

## 11.3 Configuration options for start-up

- **Configuration with the Bürkert Communicator software on PC**  
This type of configuration is possible for all device types and device variants.



The Bürkert Communicator software can be downloaded free of charge from the Bürkert website.

It requires the USB büS interface set available as an accessory.  
Communication is performed via the device's büS service interface.

- **Configuration on display of device (optional)**  
Only possible on devices with display module.
- **Use two capacitive buttons in device to adjust position control (X.TUNE function)**  
Only possible on devices without display module.

## 11.4 Base settings



A start-up wizard that provides step-by-step guidance through the base settings is available for Bürkert Communicator and the display.

(Configuration area → **Position controller** or  
**Process controller** → **START-UP**)

### 11.4.1 Base settings for position control



Before delivery, the base settings for the position control have already been input by the manufacturer. See diagrams below.

Type of base setting (observe sequence)		Factory default setting
1.	Set safety position	Close/open (dependent on device variant)
2.	Adjustment of position control (X.TUNE function)	Factory setting <b>NOTE:</b> If the actuator is disassembled, X.TUNE function must be carried out again before start-up.
3.	Set standard signal for set-point position	Signal type analogue: 4...20 mA
		Gateway: Specified by Fieldbus
4.	Set AUTOMATIC operating state	MANUAL

Table 30: Overview: Base settings for position control

### 11.4.2 Base settings for process control



Before delivery, important base settings for the process control have already been input by the manufacturer. See diagrams below.

Type of base setting (observe sequence)		Factory default setting	
1.	Set safety position	Close/open (dependent on device variant)	
2.	Adjustment of position control (X.TUNE function)	Factory setting <b>NOTE:</b> If the actuator is disassembled, X.TUNE function must be carried out again before start-up.	
3.	Select physical unit for process control	Per cent	
4.	Configure process values		
	a)	Select standard signal for process set-point value	Signal type analogue: 4...20 mA Gateway: Specified by Fieldbus
	b)	Scale process set-point value	Minimum 0%, maximum 100%
	c)	Select standard signal for process actual value	4–20 mA
	d)	Scale process actual value	Minimum 0%, maximum 100%
5.	Scaling the process control	Minimum 0%, maximum 100%	
6.	Set dead band for process control	1%	
7.	Set up process control		
		Linearising process characteristic* (function P.LIN)	
	a)	In addition for devices without a display: Set DIP switch 2 to ON to activate the correction characteristic.	-
	b)	Adjust process control ** (P.TUNE function)	-
8.	Set AUTOMATIC operating state	MANUAL	

Table 31: Overview: Base settings for position control

\* Only necessary if process characteristic varies substantially from linearity. Linearisation using the function P.LIN can take a lot of time with slow processes.

\*\*The P.TUNE function supports process control set-up by independently optimising process parameters. The process of fine-tuning process parameters is described in the Type 3360, 3361 software description.

## 11.5 Set safety position



### Setting option:

Using the Bürkert Communicator software or the display of the device (optional).

Settings are created on the PC using the büS service interface and the Bürkert Communicator software. It requires the USB büS interface set available as an accessory.

Display operation: Button functions

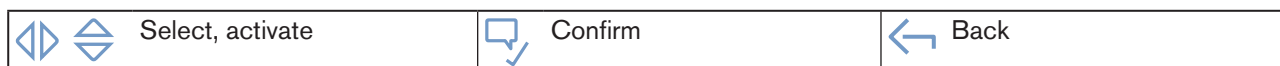

To adjust the safety position, switch to the “Parameters” detailed view for position controllers.

### How to switch to detailed view:

→ When using Bürkert Communicator for the configuration, select **Position Controller** in the navigation area.

→ When using the display for the configuration, switch to **CONFIGURATION** on the home screen and select **Position Controller**.

✓ You are now in the “Parameter” detailed view.

### How to configure the safety position:

→ **Select SAFEPOS.**

→ Select **FUNCTION.**

The following safety positions are available to choose from:

**Close** Valve tightly closed.

**Open** Valve opened.

**User-defined** User-defined safety position.  
The entry of the position in this menu is described below.

**Inactive** Valve remains in an undefined position.

→ Set safety position.

### Entry of user-defined safety position (only if **user-defined** safety position is selected).

→ **Select** position.

→ Enter safety position  
(0% = closed, 100% = open).

✓ The safety position is now configured.

## 11.6 Adjustment of position controller – execute X.TUNE

When executing the X.TUNE function, the position control is adjusted at the physical stroke of the actuator in use.

**Devices come with the X.TUNE function performed by the manufacturer.**

### NOTE!

**Only perform X.TUNE if required!**

The X.TUNE function only has to be executed again if the actuator has been dismantled or the valve body has been replaced.



### WARNING!

**Danger due to uncontrolled process after executing the X.TUNE function.**

Executing X.TUNE under operating pressure will cause an adjuster error. The result is an uncontrolled process.

- ▶ Never perform X.TUNE under operating pressure.
- ▶ Secure the system against unintentional activation!

### 11.6.1 Adjustment of position controller with buttons in device

The two buttons for triggering X.TUNE are located beneath the blind cover.

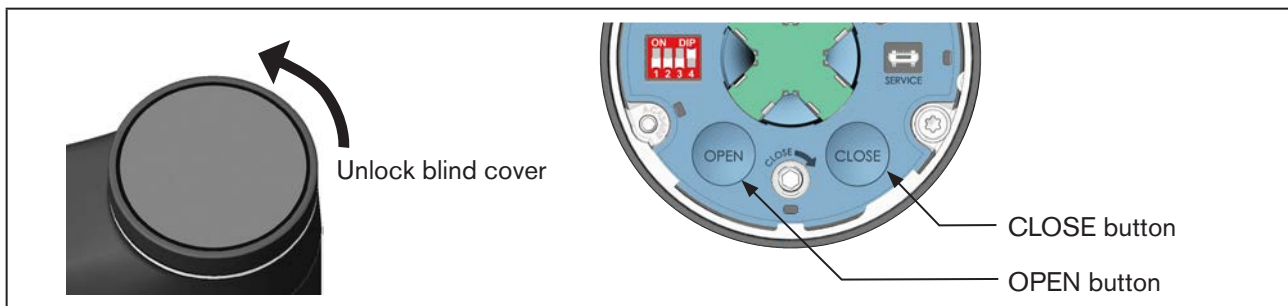

Image 27: Adjustment of position controller with buttons in device

#### Remove the blind cover:



**Devices with ATEX approval or IECEx approval are secured with a magnetic lock.**

The removal of the cover is described in the supplementary instructions for the electromotive control valves with ATEX approval and IECEx approval.

→ To unlock the blind cover, turn it counterclockwise and remove

#### Trigger the X.TUNE function:

⚠ Make sure that there is no operating pressure!  
Only perform X.TUNE when necessary.

→ Hold down the OPEN and CLOSE buttons together at the same time for 5 seconds.

The LED illuminated ring will light up orange while the X.TUNE is executed.  
When X.TUNE is finished, the LED illuminated ring returns to its previous status.

## 11.6.2 Adjustment of position control on PC or device display



Settings are created on the PC using the büS service interface and the Bürkert Communicator software. It requires the USB büS interface set available as an accessory.

Display operation: Button functions

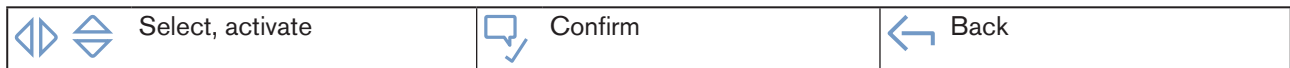

To trigger the X.TUNE function, you must switch to the “Maintenance” detailed view for position controllers.

### How to switch to detailed view:

→ When using Bürkert Communicator for the configuration, select **Position Controller** in the navigation area and switch to **MAINTENANCE**.

→ When using the display for the configuration, switch to **CONFIGURATION** on the home screen, select **Position Controller** and switch to **MAINTENANCE**.

✓ You are now in the “Maintenance” detailed view.

How to trigger the X.TUNE function:

⚠ Make sure that there is no operating pressure!

→ **Select CALIBRATION.**

→ Select **X.TUNE**.

The following text appears: “Select seal material (see type label)!”

→ Select seal material.

The following question appears: “Do you really want to start X.TUNE?”

⚠ Only start X.TUNE if absolutely necessary.

→ Start X.TUNE.

✓ This will execute the X.TUNE function.



If X.TUNE is aborted due to an error, a message will appear (see subsequent table).

Possible messages when X.TUNE is aborted	Description
Device error present.	There is an error present that makes it impossible to execute X.TUNE.
Timeout.	X.TUNE could not be executed within the time limit due to an error.
The motor current is too great.	The motor current is too great for the X.TUNE function.
The lower end position of the valve is not recognised.	The lower end position of the valve cannot be recognised by the position sensor.

Table 32: Possible error messages after abort of the X.TUNE function

## 11.7 Set standard signal for set-point position





### Setting option:

Using the Bürkert Communicator software or the display of the device (optional).

Settings are created on the PC using the bÜS service interface and the Bürkert Communicator software. It requires the USB bÜS interface set available as an accessory.

Display operation: Button functions

 Select, activate	 Confirm	 Back
--	---	--

To set the standard signal, switch to the “Parameters” detailed view for inputs/outputs.

### How to switch to detailed view:

- When using Bürkert Communicator for the configuration, select **Inputs/Outputs** in the navigation area.
- When using the display for the configuration, switch to **CONFIGURATION** on the home screen and select **Inputs/Outputs**.
- ✓ You are now in the “Parameter” detailed view.

How to configure the standard signal:

- **Select CMD.**
- Select **ANALOG.type.**
- Select standard signal.
- ✓ The standard signal is now configured.

## 11.8 Select physical unit for process control





### Setting option:

Using the Bürkert Communicator software or the display of the device (optional).

Settings are created on the PC using the büS service interface and the Bürkert Communicator software. It requires the USB büS interface set available as an accessory.

Display operation: Button functions

 Select, activate	 Confirm	 Back
--	---	--

To select the physical unit, switch to the “Parameters” detailed view for process controllers.

### How to switch to detailed view:

→ When using Bürkert Communicator for the configuration, select **Process Controller** in the navigation area.

→ When using the display for the configuration, switch to **CONFIGURATION** on the home screen and select **Process Controller**.

✓ You are now in the “Parameter” detailed view.

### How to select the physical unit for process control:

→ **Select UNIT.**

→ Select physical unit.

✓ The physical unit is now selected.

## 11.9 Configure process values







### Setting option:

Using the Bürkert Communicator software or the display of the device (optional).

Settings are created on the PC using the büS service interface and the Bürkert Communicator software. It requires the USB büS interface set available as an accessory.

Display operation: Button functions

  Select, activate	 Confirm	 Back
--	---	--

To configure process values, you must go to the “Parameters” detailed view for inputs/outputs.

### How to switch to detailed view:

- When using Bürkert Communicator for the configuration, select **Inputs/Outputs** in the navigation area.
- When using the display for the configuration, switch to **CONFIGURATION** on the home screen and select **Inputs/Outputs**.

✔ You are now in the “Parameter” detailed view.

### 11.9.1 Selecting and scaling standard signal for process set-point value

How to select the standard signal for the process set-point value:

- **Select SP/CMD.**
- Select **ANALOG.type.**
- Select standard signal.
- ✔ The standard signal for the process set-point value is now selected.

How to scale the process set-point value:

- **Select SP.scale.**
- Enter the minimum and maximum values.
- ✔ The process set-point value is now configured.

### 11.9.2 Selecting and scaling standard signal for process actual value

How to select the standard signal for the process actual value:

- **Select PV.**
- Select **ANALOG.type.**
- Select standard signal.
- ✔ The standard signal for the process actual value is now selected.

How to scale the process actual value:

- **Select PV.scale.**



→ Enter the minimum and maximum values.

✔ The process actual value is now configured.

## 11.10 Scaling the process control

Scaling process control affects the following functions:

- Dead band for process control
- Sealing function (CUTOFF), if process control (P.CO) is selected in menu CUTOFF → CUTOFF.type.







### Setting option:

Using the Bürkert Communicator software or the display of the device (optional).

Settings are created on the PC using the bÜS service interface and the Bürkert Communicator software. It requires the USB bÜS interface set available as an accessory.

Display operation: Button functions

 	Select, activate		Confirm		Back
---	------------------	---	---------	---	------

To scale process control, switch to the “Parameters” detailed view for process controllers.

### How to switch to detailed view:

→ When using Bürkert Communicator for the configuration, select **Process Controller** in the navigation area.

→ When using the display for the configuration, switch to **CONFIGURATION** on the home screen and select **Process Controller**.

✔ You are now in the “Parameter” detailed view.

### How to scale process control:

→ **Select P.CO.scale.**

→ Enter the minimum and maximum values.

✔ The process control is now scaled.

## 11.11 Set dead band for process control



### Setting option:

Using the Bürkert Communicator software or the display of the device (optional).

Settings are created on the PC using the bÜS service interface and the Bürkert Communicator software. It requires the USB bÜS interface set available as an accessory.

Display operation: Button functions

	Select, activate		Confirm		Back
--	------------------	--	---------	--	------

To set the dead band, switch to the “Parameters” detailed view for process controllers.

### How to switch to detailed view:

→ When using Bürkert Communicator for the configuration, select **Process Controller** in the navigation area.

→ When using the display for the configuration, switch to **CONFIGURATION** on the home screen and select **Process Controller**.

✓ You are now in the “Parameter” detailed view.

### How to configure the dead band:

→ **Select PID.PARAMETER.**

→ Select **DBND.**

→ Enter percentage value.

✓ The dead band is now configured.

## 11.12 Setting up process control and executing P.LIN, P.TUNE



### Setting option:

Using the Bürkert Communicator software or the display of the device (optional).

Settings are created on the PC using the büS service interface and the Bürkert Communicator software. It requires the USB büS interface set available as an accessory.

Display operation: Button functions

 Select, activate	 Confirm	 Back
--	---	--

To set up process control, switch to the “Maintenance” detailed view for process controllers.

### How to switch to detailed view:

→ When using Bürkert Communicator for the configuration, select **Process Controller** in the navigation area and switch to **MAINTENANCE**.

→ When using the display for the configuration, switch to **CONFIGURATION** on the home screen, select **Process Controller** and switch to **MAINTENANCE**.

✓ You are now in the “Maintenance” detailed view.

### 11.12.1 Linearising process characteristic (P.LIN)

#### How to linearise the process characteristic:

→ **Select CALIBRATION.**

→ Select **P.LIN**.

→ The following text appears: “Do you really want to start P.LIN?”

→ Start P.LIN.

✓ This will execute the P.LIN function.

### 11.12.2 For devices without a display – activate the correction characteristic

DIP switch 2, which is located under the blind cover, is used to activate the correction characteristic.

→ To unlock the blind cover, turn it counterclockwise and remove.



**Devices with ATEX approval or IECEx approval are secured with a magnetic lock.**

The removal of the cover is described in the supplementary instructions for the electromotive control valves with ATEX approval and IECEx approval.

→ Set DIP switch 2 to ON. The correction characteristic is now enabled.

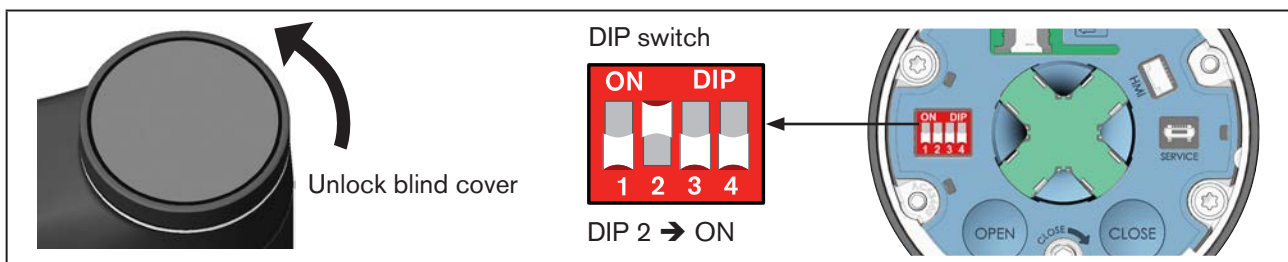

Image 28: Activate correction characteristic

→ Close the blind cover.

### 11.12.3 Adjusting process control (P.TUNE)

**How to trigger the P.TUNE function:**

→ **Select CALIBRATION.**

→ Select **P.TUNE.**

The following text appears: "Do you really want to start P.TUNE?"

→ Start P.TUNE.

✓ This will execute the P.TUNE function.



The LED illuminated ring will light up orange while the functions P.LIN and P.TUNE are executed. If it is aborted due to an error, a message will appear.

## 11.13 Set AUTOMATIC operating state

**Factory setting:** Devices in their factory default state have their operating state preset to MANUAL.

### 11.13.1 Setting AUTOMATIC operating state for devices without a display module

DIP switch 4, which is located under the blind cover, is used to set the operating state.



**Devices with ATEX approval or IECEx approval are secured with a magnetic lock.**

The removal of the cover is described in the supplementary instructions for the electromotive control valves with ATEX approval and IECEx approval.

→ To unlock the blind cover, turn it counterclockwise and remove.

→ Set AUTOMATIC operating state with DIP switch 4.

	<b>Operating state</b>	
	AUTOMATIC: DIP 4 → down	MANUAL: DIP 4 → up (ON)

→ Close the blind cover.

### 11.13.2 Setting AUTOMATIC operating state for devices with a display module

This setting is changed in the MANUAL/AUTO layout.



The MANU/AUTO layout is pre-defined in factory settings for the home screen (factory designation: View 1...).

To access the home screen, hold down the  Back key.

See also chapter [“13.3.1 Home screen and user-specific views”](#) on page 86.

→ To change the operating mode, briefly press the  Menu button.

AUTOMATIC operating state: The MANUAL icon  and the two arrow icons labelled “open” and “close” are hidden.

**Home screen** (factory designation: View 1...)  
 Layout: MANUAL/AUTO  
 Display: in MANUAL operating state.

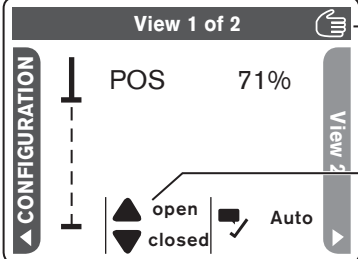

Icon for MANUAL operating state: MANUAL icon is displayed  
 AUTOMATIC: MANUAL icon is hidden

Arrow icons labelled “open” and “closed”  
 MANUAL: Arrow icons are displayed  
 AUTOMATIC: Arrow icons are hidden

Image 29: Icons for operating state

→ Set AUTOMATIC operating state.

## 12 OPERATION



### WARNING!

#### Risk of injury from improper operation!

Improper operation may result in injuries as well as damage to the device and its surroundings.

- ▶ The operating personnel must know and understand the contents of the operating instructions.
- ▶ The safety instructions and the intended use must be observed.
- ▶ Only adequately trained personnel may operate the equipment/the device.

Different operating elements are available for operating the device, depending on the variant.

#### ▪ Standard devices without display module

Operation is performed with 2 capacitive buttons and 4 DIP switches.

#### ▪ Option – devices with display module

Operation and configuration are performed on the display with buttons for touch operation.

#### ▪ Additional operating options

Alternatively, the device can be configured using a PC. Settings are created using the bÜS service interface and the Bürkert Communicator software.

It requires the USB bÜS interface set available as an accessory.

### 12.1 Overview: Availability of the operating elements

Operating element	Function	Availability	
		Devices without display module	Devices with display module
4 DIP switches	Set effective direction	yes	no (available, but without function. Configuration via display)
	Enabling, disabling correction characteristic		
	Enable, disable sealing function		
	Switch to AUTOMATIC, MANUAL operating state		
OPEN button	Opening the valve	yes	
CLOSE button	Closing the valve:		
OPEN button and CLOSE button	Adjustment of position control, perform X.TUNE function	yes	
Mechanical manual override	Mechanically opening or closing the valve	yes	yes
SIM card holder	Holder for using the SIM card available as an accessory	yes	yes
bÜS service interface	For connecting a CAN adapter or the USB bÜS interface set available as an accessory	yes	yes
Bürkert Communicator software	Software for configuration and setting the device on a PC	yes	yes
Display with buttons for touch operation	Configuring, setting and operating the device	no	yes

Table 33: Operating possibilities

## 12.2 Display elements

Description of the display elements:

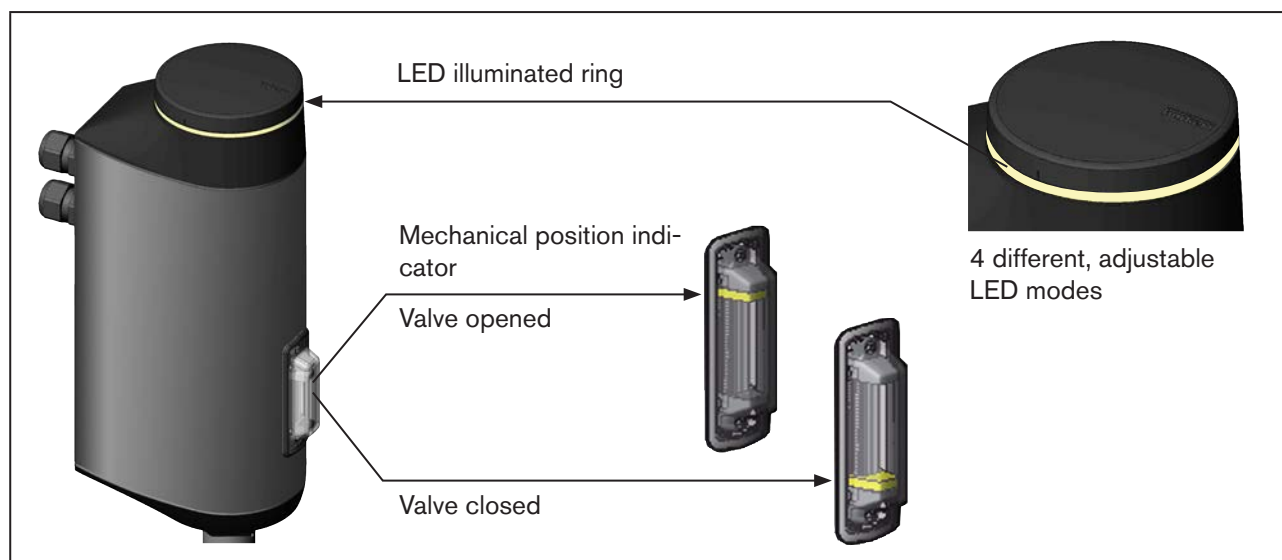

Image 30: Display elements

### 12.2.1 LED illuminated ring

The transparent LED light ring that transmits the light of the LEDs to the outside is fitted to the blind cover or display module.

The LED illuminated ring lights up or flashes slowly or quickly in one or several alternating colours to indicate the device's state.

4 different LED modes can be set for the LED light ring:

- NAMUR operation mode\*
- Valve mode\*
- Valve mode + warnings\* – factory pre-set operation mode
- LED off



\* The complete description of the device states, errors and warnings that are displayed in LED mode can be found in chapter [“6.4 Display of the device status”](#).

## 12.2.2 Set LED operation mode







### Setting option:

Using the Bürkert Communicator software or the display of the device (optional).

Settings are created on the PC using the büS service interface and the Bürkert Communicator software. It requires the USB büS interface set available as an accessory.

Display operation: Button functions

  Select, activate	 Confirm	 Back
--	---	--

To configure, you must switch to the detailed view “Parameter for general settings”.

### How to switch to detailed view:

- When using Bürkert Communicator for the configuration, select **General settings** in the navigation area.
- When using the display for the configuration, switch to **CONFIGURATION** on the home screen and select **General settings**.

✔ You are now in the “Parameter” detailed view.

### How to set LED operation mode:

- **Select Status LED.**
- Select **Operation mode.**

The following LED operation modes are available:

**NAMUR operation mode**

**Valve mode**

**Valve mode + warnings**

**LED off**

- Select LED operation mode.

✔ You have set the LED operation mode.

## 12.2.3 Mechanical position indicator

The valve position is read from the mechanical position indicator even if the supply voltage fails (see [“Image 30: Display elements”](#))

## 12.2.4 Display elements of the display module (optional)

For a description see [“13 Display operation \(option\)”](#)



## 12.3 Operating elements

Presentation of the operating elements:

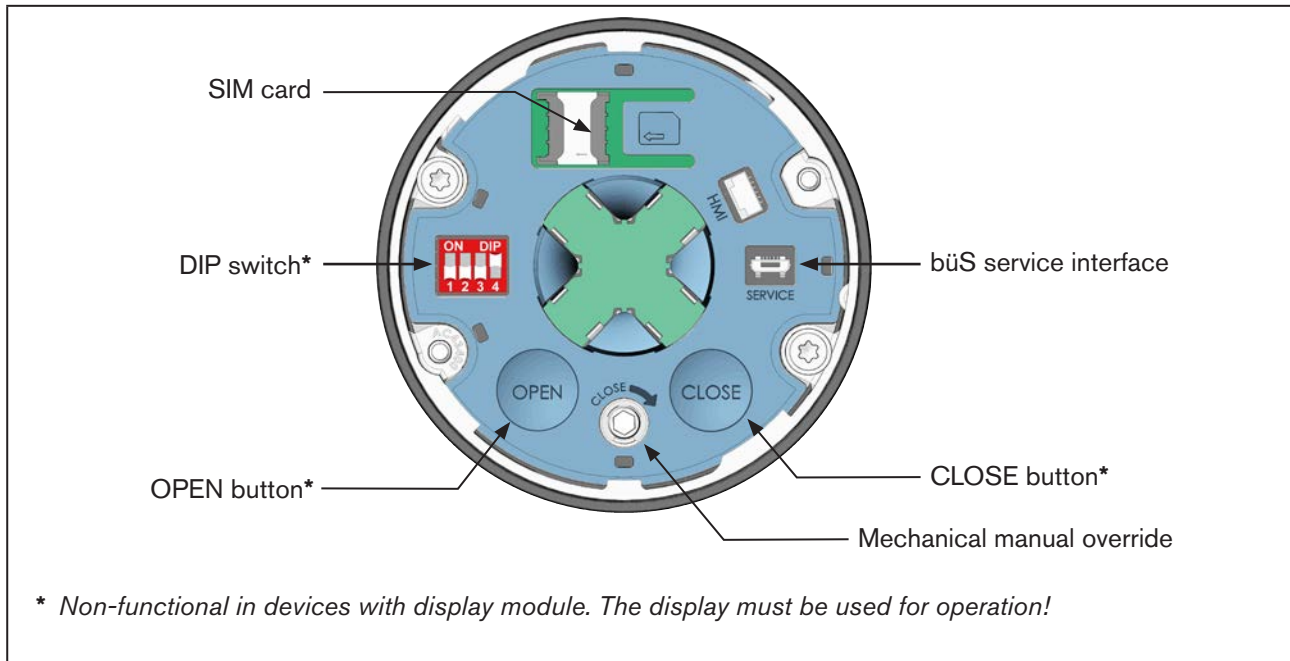

Image 31: Operating elements

### 12.3.1 DIP switch

#### Settings

- Switch 1: Sets the effective direction between input signal and set-point position. See chapter [“14.4”](#) on page 102.
- Switch 2: Enables or disables the correction characteristic (for adjusting the operating characteristic) (see chapter [“14.3”](#) on page 99).
- Switch 3: Enables or disables sealing function. See chapter [“14.2”](#) on page 97.
- Switch 4: Switch between AUTOMATIC and MANUAL operating state. See chapter [“14.1”](#) on page 94.



The DIP switches are non-functional in devices with a display module. The configuration can only be performed on the display.

### 12.3.2 OPEN button and CLOSE button

- Electrical manual override: Opening valve: Press OPEN button  
Closing valve: Press CLOSE button. See chapter [“15.1”](#).
- Trigger X.TUNE (Autotune): For a description see chapter [“11.6 Adjustment of position controller – execute X.TUNE”](#).



If the device has a display module, the OPEN and CLOSE buttons will have no function. The configuration can be performed on the display.

### 12.3.3 Mechanical manual override

If there is no supply voltage, e.g. during installation or in the event of a power failure, the valve can be opened or closed using the mechanical manual override.

For a description see chapter [“15.4 Actuating the valve mechanically”](#)

## 12.4 büS service interface

The büS service interface can be used for quick service.

- Configuration of the device, e.g. the base setting for start-up with the software Bürkert Communicator. It requires the USB büS interface set available as an accessory.
- Configuration of the büS network.
- Parameterising of operation parameters
- Error diagnostics
- Software update

Only connect the matching CAN adapter to the büS service interface. This CAN adapter is part of the USB büS interface set available as an accessory (see [“Table 48: Accessories”](#) on page 152).

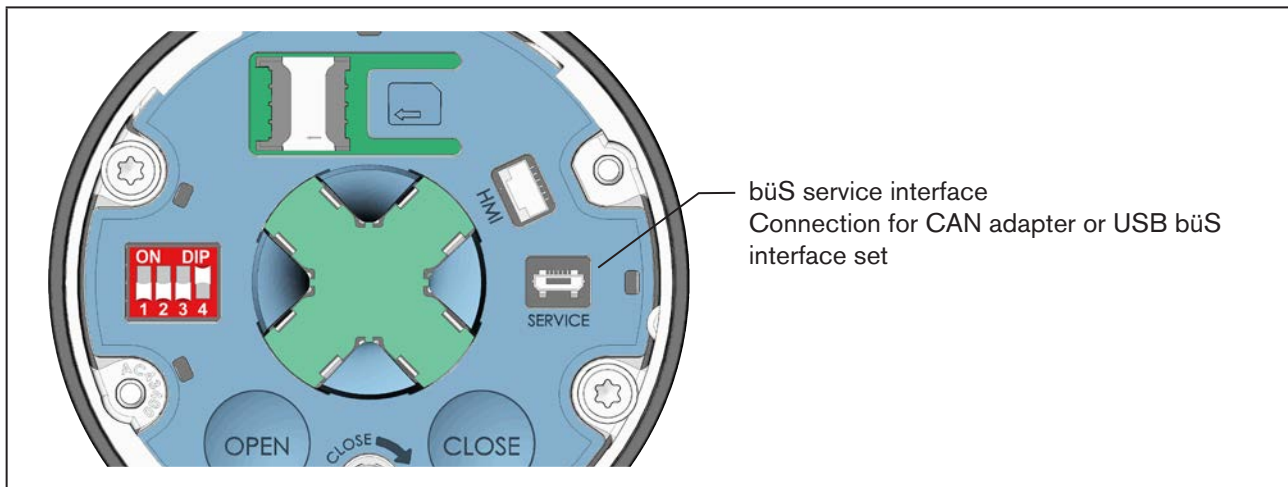



Image 32: büS service interface

 For devices with a fieldbus gateway, the büS service interface is inside the fieldbus gateway (see chapter [“18.1.1 Access to büS service interface”](#) on page 135).

## 12.5 SIM card – acquire and save data (option)

The optional SIM card can be used to store device-specific values and user settings and transfer them to another device.

The SIM card is detected when the device starts and is checked for available data. This data will be transferred or overwritten accordingly:

- The SIM card does not contain any data.  
The existing device-specific values and user settings are saved to the SIM card.
- The SIM card contains data compatible with the device.  
The data on the SIM card are transferred by the device. The existing device-specific values and user settings are overwritten.
- The SIM card contains data that are not compatible with the device.  
The device overwrites the data on the SIM card with its own device-specific values and user settings.

### NOTE!

#### Do not use a standard SIM card for the device.

The SIM card used is a special industrial version that offers additional durability and temperature-resistance. Only purchase the SIM card for the electromotive control valves from your Bürkert sales department. See chapter “24 Accessories, replacement parts”.

#### Do not remove the SIM card during operation.

During operation, parameter changes are immediately saved to the SIM card. If the SIM card is removed during operation, data may be lost and the SIM card damaged.



The SIM card can be inserted during operation.  
A restart is required to ensure that the device detects the SIM card.

### Inserting the SIM card:

- Place the SIM card on the surface with the SIM card symbol. The position must correspond to that shown on the symbol.
- Gently push the SIM card to the left into the holder until it stops.
- Restart the device. The new data are transmitted.

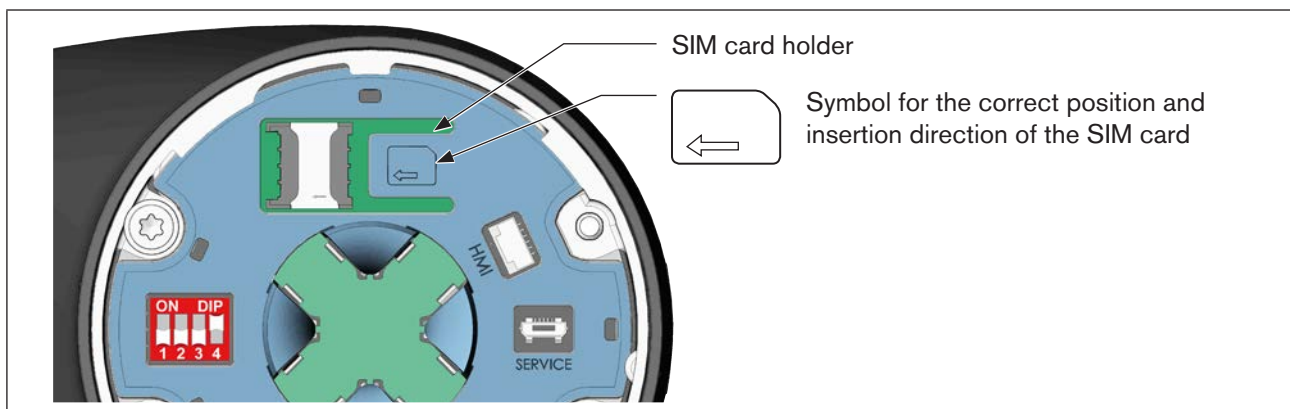

Image 33: Using the SIM card

## 13 DISPLAY OPERATION (OPTION)

The device is operated and configured using buttons on a touchscreen display.

### 13.1 User interface

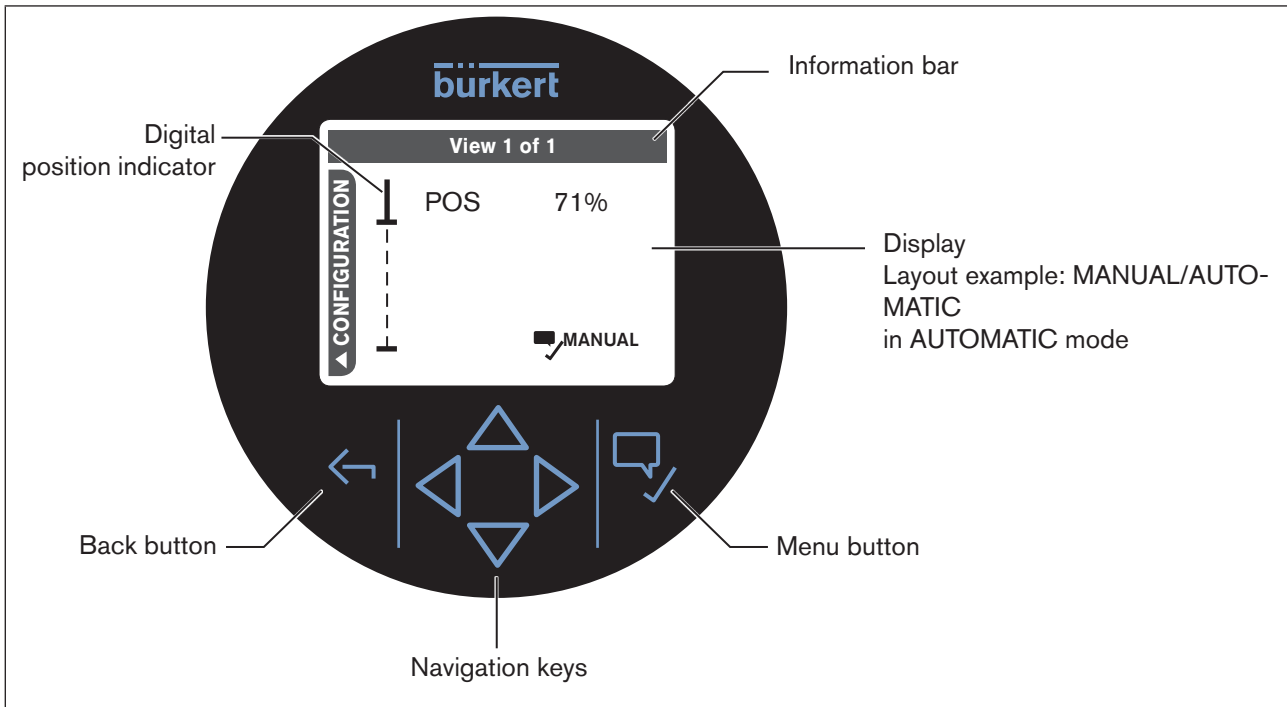

Image 34: User interface

### 13.2 Description of buttons

Key		Functions	
Back button		Press briefly:	Back
		Hold down:	Return to home screen (View 1...)
Navigation keys		Change view	
		Accept selection (e.g. with option fields)	
		When entering values: Change decimal place	
		Select menu	
		Configuration, select setting	
		When entering values: Change value (digit)	
		Open valve (in MANUAL operating state)	
	Close valve (in MANUAL operating state)		

Key		Functions	
Menu button		Press briefly:	Confirm selection
			Save selection
			Next (in wizard)
		Hold down:	Open context menu

Image 35: Description of button function

### 13.3 Display views

The following views can be accessed from the home screen:

- **Configuration view**, using the left navigation button ◀
- **From user-created view 2–4**, using the right navigation button ▶  
 See also [“13.3.1 Home screen and user-specific views” on page 86.](#)

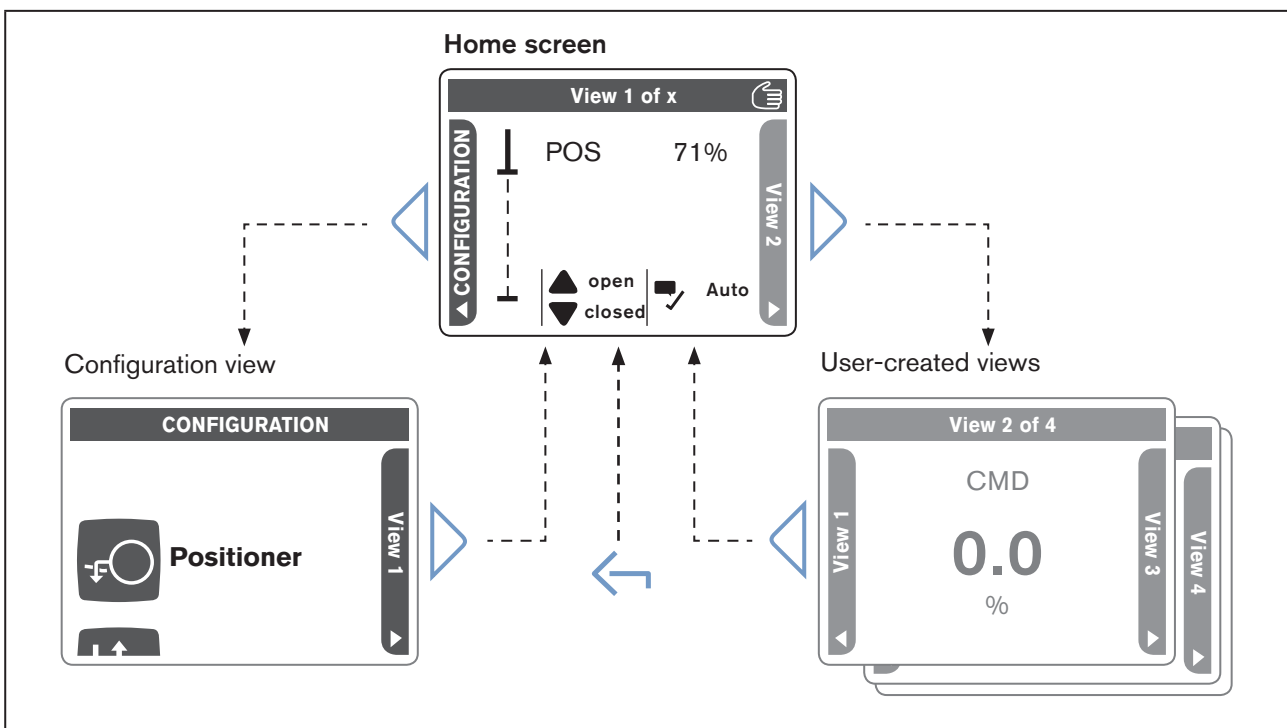

Image 36: Home screen, configuration view, user-specific views

### 13.3.1 Home screen and user-specific views

In addition to the home screen, other user-specific views can be created. The title of the view is displayed in the information bar.



The home screen title preset at the factory (View 1...) and the other views can be changed in the context menu.

Five different layouts are available for each view:

**1 value**

1 process value is displayed in the view.

**2 values**

2 process values are displayed in the view.

**4 values**

4 process values are displayed in the view.

**Trend**

The process sequence is depicted as a curve in the view.

**Trend with 2 values**

The process sequence is depicted as a curve and with 2 process values in the view.

**MANUAL/  
AUTOMATIC**

Preset at the factory for the home screen (see “Image 36”).

The position of the valve is depicted as a value and in a position indicator in the view. The icons for AUTOMATIC and MANUAL operating state, and for closing and opening the valve, are displayed.

**Setting:**

You can create views, change their title and assign the layout either in the context menu on the home screen or from a user-specific view.

To open the context menu, hold down the menu key .



The comprehensive, detailed description for the display module can be found on our homepage <https://country.burkert.com/> at: Type ME31 → Software ME31.

### 13.3.2 Configuration view

The configuration view is divided in various areas.





Icon	Configuration area
	Positioner
	Inputs/outputs
	Process controller
	Industrial communication
	Displays
	General settings

Table 34: Configuration areas

You can switch between the areas with the navigation buttons  and .

### 13.3.3 Detailed views

From the configuration view you can access the following detailed views:

Detailed view	How to access the detailed view from the configuration view
Parameters	Select  Configuration area* and  confirm selection.
Maintenance	Select  Configuration area* and  confirm selection.  Switch to detailed view <b>MAINTENANCE</b> .

\* See "Table 34: Configuration areas" on page 87.

Table 35: Detailed views

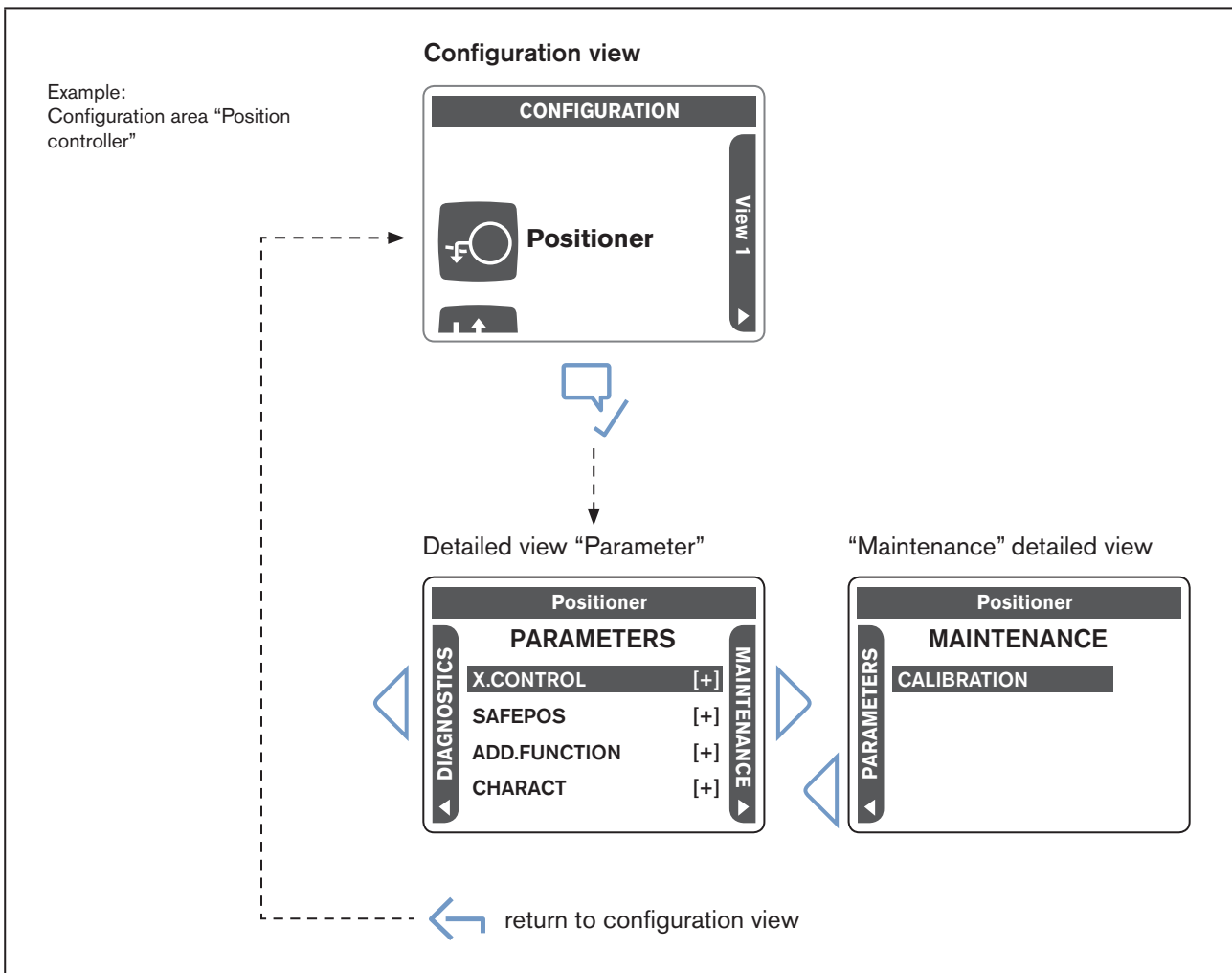

Image 37: Detailed views; Parameter, Maintenance, Diagnostics

MAN 1000274112 EN Version: G Status: RL (released | freigegeben) printed: 28.05.2021



## 13.4 Description of symbols

### Symbols for access rights







Icon	Description
	This setting is write-protected and can only be modified with the appropriate access rights/user code.
	User
	Advanced user is logged on to the device.
	Installer is logged on to the device.
	Bürkert service employee is logged on to the device.

Table 36: Symbols for access rights

 The rights to read, configure or alter data depend on the set access right and password protection. See chapter [“13.5 Access rights and password protection”](#) on page 91.

### Icons for indicating device status in accordance with NAMUR NE 107

If several device statuses exist simultaneously, the device status with the highest priority is displayed.





Priority	Icon	Description
1		Failure, error or fault! Due to a malfunction in the device or its peripherals, closed-loop control mode is not possible. → Review the messages in the message list.
2		Function check! Work is being carried out on the device, which means that closed-loop control mode is temporarily not possible.
3		Outside of specification! The environment conditions or process conditions for the device are not within the specified range. Internal device diagnostics indicate problems within the device or with the process properties.
4		Maintenance required! The device is in closed-loop control mode, but function will soon be restricted. → Perform device maintenance.

Table 37: Symbols in accordance with NAMUR NE 107

**Symbols for displaying operating states**







Priority	Icon	Description
1		Device is no longer in closed-loop control mode due to a severe error. The valve is stuck in its position.
2		Energy pack active: The supply voltage has been interrupted. The device is supplied with power via the energy pack. In AUTOMATIC operating state the actuator moves to the safety position (see icon "safety position") In MANUAL operating state the actuator is stuck in the last assumed position.
3		Device is in MANUAL operating state.
4		Device is in SIMULATION operating state. The signal for the set-point value setting default is simulated.
5		Process control active
6		Position control active

Table 38: Symbols for displaying operating states

**Symbols for displaying specific valve positions**



Priority	Icon	Description
1		Valve is in the safety position.
2		Valve is in the sealed position.

Table 39: Symbols for displaying specific valve positions

## 13.5 Access rights and password protection

There are three user levels for assigning access rights.

If password protection is enabled, the information bar of the display displays the enabled user level with the corresponding icon.



User level	Icon	Description
<b>Advanced user</b>		PIN required: manufacturer-set code 005678 Rights: reading values, limited right to change values.
<b>Installer</b>		PIN required. Manufacturer-set code 001946 Rights: reading values, expanded right to change values.
<b>Bürkert</b>		PIN required. Only for Bürkert employees

Table 40: User levels

### 13.5.1 Factory setting

Password protection is not enabled on delivery. Settings in the software can be made at any time and without entering a password.

A password is only required for settings that only Bürkert employees are permitted to make.

### 13.5.2 Enabling password protection

You must switch to the detailed view "Parameters for general settings" to enable or disable password protection.

**How to switch from the home screen to the detailed view:**

→  switch to **CONFIGURATION**.

→   Select **General settings** and  confirm selection.

✓ You are now in the "Parameter" detailed view.

**How to enable password protection and change passwords:**

→  select **Passwords** and  confirm.

→  Select **Password protection** and  confirm.









→  Select **On** and  confirm.

✓ You have enabled password protection.

Effect: Software settings that require a specific user level can only be made upon entering the corresponding user level code.

→ Return with .

After password protection is enabled, you can change the passwords for the user levels.







-  Select **Change passwords** and  confirm.
-  Select user level and  confirm.
- Enter code: enter with  decimal point; change with  value of the decimal point.
- Confirm the set code .
- ✔ You have changed the user level password.
- Return with .

 **Note!** Document passwords such that they are always accessible to authorised persons. Once the screen saver is active, settings that require a certain user level are only possible with input of a password.

 When password protection is enabled, the user level **Installer** is required to change the password protection.

### 13.5.3 Disabling password protection

The user level **Installer** is required to disable password protection.

- In the detailed view **General settings**,  select **Passwords** and  confirm.
-  Select **Password protection** and  confirm.
-  Select **Off** and  confirm.
- ✔ You have disabled password protection.
- Return with .



### 13.5.4 Changing user level

To change the user level you must switch to the context menu. Hold down the menu button .

#### How to switch user levels:

-  Select **Switch user levels**.
- Select user level.
- Set password (PIN).
- ✔ You have switched the user level.

#### Logging out of the user level:

-  Select **Log out** and  confirm.
- ✔ You have disabled the user level.

## 13.6 Screen saver

The display user interface is protected by a screen saver. Removing the screen saver:

→ Press any button and follow the instructions on the display.

Factory setting: the waiting time between operation and enabling of the screen saver is one minute.

### NOTE!

**Faulty operation as a result of EMC disruptions, cleaning work or unintended physical contact.**



▶ To prevent faulty operation, set the shortest possible waiting time for the screen saver, e.g. one minute.

### 13.6.1 Set screen saver

The setting is made in the detailed view "Parameter for displays".

**How to switch from the home screen to the detailed view:**

→  switch to **CONFIGURATION**.



→   Select **Displays** and  confirm selection.

✔ You are now in the "Parameter" detailed view.

**How to set the screen saver:**

→  select **Screen saver** and  confirm.

→  Select **Waiting time** and  confirm.

→  Select desired waiting time in **minutes** and  enable.

→  Select **Brightness** and  confirm.

→  Set desired brightness in % and  confirm.

✔ You have set the screen saver.

→ Return with .

## 14 BASIC FUNCTIONS

### 14.1 Changing the operating state, AUTOMATIC, MANUAL

**Factory setting:** Devices in their factory default state have their operating state preset to MANUAL.

#### 14.1.1 Changing operating state in devices without a display module

DIP switch 4, which is located under the blind cover, is used to change operating state.

→ To unlock the blind cover, turn it counterclockwise and remove

**!** **Devices with ATEX approval or IECEx approval are secured with a magnetic lock.**  
The removal of the cover is described in the supplementary instructions for the electromotive control valves with ATEX approval and IECEx approval.

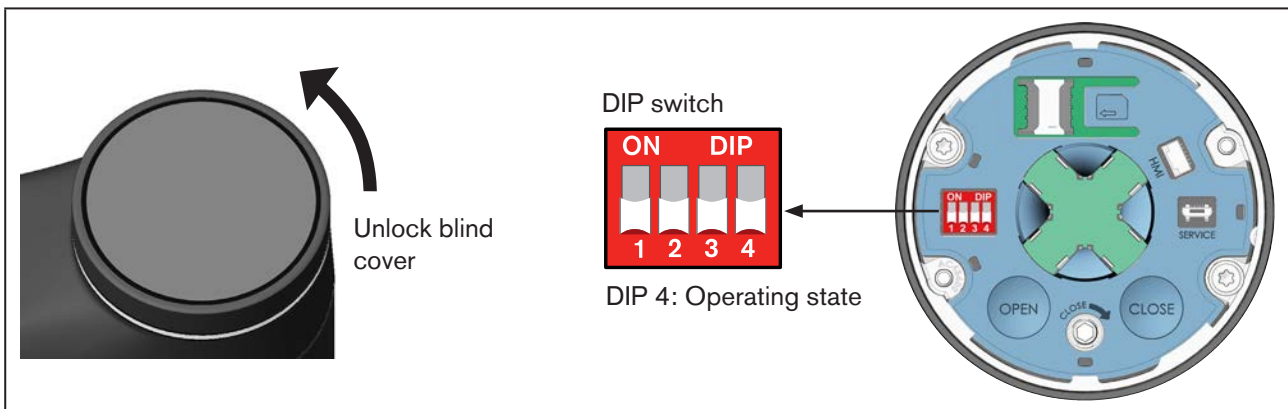
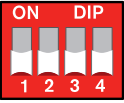

Image 38: Setting the operating state

→ Set the operating state with DIP switch 4.

	Operating state	
	AUTOMATIC: DIP 4 → down	MANUAL: DIP 4 → up (ON)

→ Close the blind cover.

## 14.1.2 Changing operating state in devices with a display module

The operating state can be set in 2 ways:

- using the menu key in the MANU/AUTO layout on the home screen or in a user-specific view.
- in the menu **AUTO | MANU**, located in the configuration area **General settings**.

### Setting using the menu button

You can change the operating state in the home screen or in a view.

If you want to change the operating state using the menu key, the view of the display must be in the MANU/AUTO layout. See "Image 39".

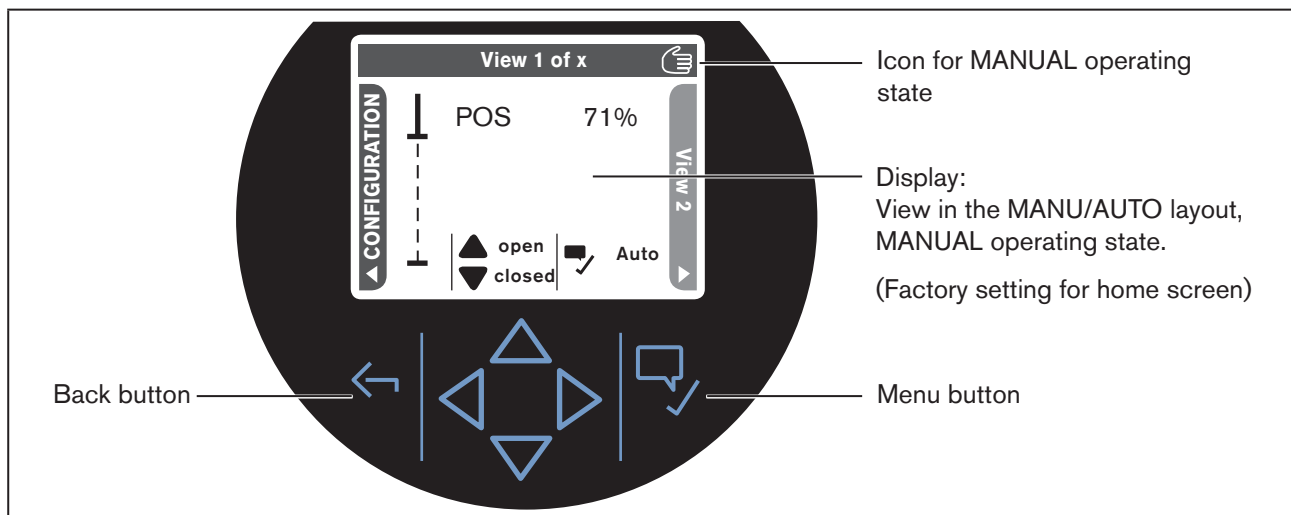





Image 39: Changing the operating state, MANUAL – AUTOMATIC

→ To change the operating mode, briefly press the  Menu button.

**MANUAL:** The MANUAL symbol  appears in the information bar at the top. The two arrow icons labelled "open" and "close" are displayed.

**AUTOMATIC:** The MANUAL icon  and the two arrow icons labelled "open" and "close" are hidden.



#### Setting the layout:

The layout settings are created in the context menu: To open the context menu, hold down the menu key .

#### MANU/AUTO layout factory setting:

The MANU/AUTO layout is pre-defined in factory settings for the home screen (factory designation: View 1...).

To access the home screen, hold down the  back key.

See also chapter "13.3 Display views" on page 85.

## Setting in the menu AUTO | MANU



### Setting option:

Using the Bürkert Communicator software or the display of the device (optional).

Settings are created on the PC using the büS service interface and the Bürkert Communicator software. It requires the USB büS interface set available as an accessory.

Display operation: Button functions

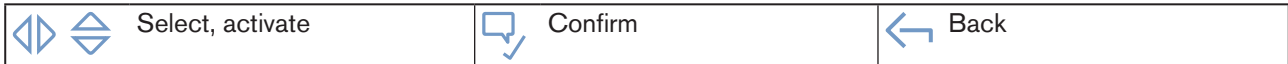

To configure, you must switch to the detailed view “Maintenance for general settings”.

How to switch to detailed view:

→ When using Bürkert Communicator for the configuration, select **General settings** in the navigation area and switch to **MAINTENANCE**.

→ When using the display for the configuration, switch to **CONFIGURATION** on the home screen, select **General settings** and switch to **MAINTENANCE**.

✓ You are now in the “Maintenance” detailed view.

How to set the operating state:

→ **select AUTO | MANU**.

→ Select **Automatic mode** or **Manual mode**.

✓ You have set the operating state.



The MANUAL operating state includes the menu **AUTO | MANU** and the menu **Manual mode** for manual override of the valve.



## 14.2 Enable – disable sealing function

**Factory setting:** The sealing function is disabled in devices upon delivery.

This function causes the valve to seal or open completely within the set range.

The parameters for the sealing or opening of the valve (CMD) is stated in per cent. The transfer from sealing or opening to closed-loop control mode occurs with a hysteresis of 1%.

If the process valve is in the sealing range, an icon appears on the display.

### 14.2.1 Enabling or disabling sealing function in devices without a display module



The sealing function must be configured for enabling.

Configuration is performed on a PC via the bÜS service interface and with the Bürkert Communicator software. It requires the USB bÜS interface set available as an accessory.

The process for configuration on a PC is the same as on the device display. Configuration is described in chapter "14.2.3 Configuring the sealing function".

DIP switch 3, which is located under the blind cover, is used to enable the sealing function.



**Devices with ATEX approval or IECEx approval are secured with a magnetic lock.**

The removal of the cover is described in the supplementary instructions for the electromotive control valves with ATEX approval and IECEx approval.

→ To unlock the blind cover, turn it counterclockwise and remove

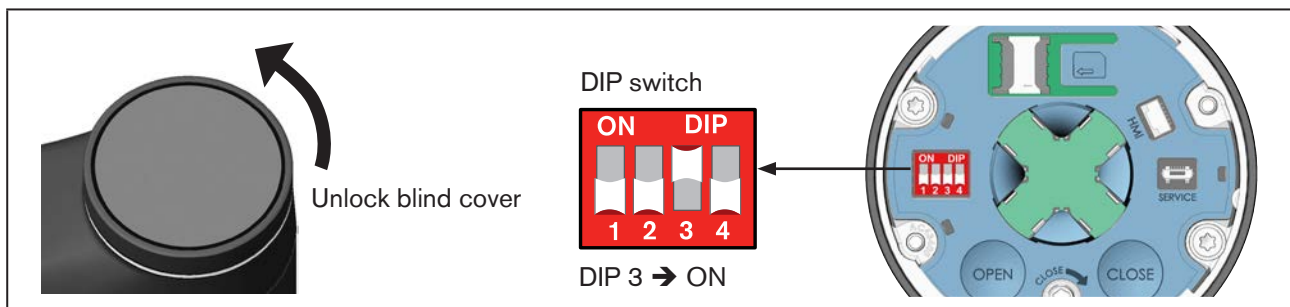

Image 40: Enable sealing function

→ Set DIP switch 3 to ON. The sealing function is enabled.

→ Close the blind cover.

## 14.2.2 Enable or disable sealing function in devices with a display module

To enable or disable the sealing function, you must switch to the detailed view "Parameter for position controller".

**How to switch from the home screen to the detailed view:**



→  switch to **CONFIGURATION**

→   select **Position controller** and  confirm selection.

✔ You are now in the "Parameter" detailed view.

**How to enable the sealing function:**

→  select **ADD.FUNCTION** and  confirm.

→  Select **CUTOFF**, enable with the navigation buttons  on the side and  confirm.

The device returns to the "Parameter" detailed view.

The sealing function is enabled and the menu **CUTOFF** for configuration is now available in the "Parameter" detailed view.

→ Return with .

## 14.2.3 Configuring the sealing function







### Setting option:

Using the Bürkert Communicator software or the display of the device (optional).

Settings are created on the PC using the bÜS service interface and the Bürkert Communicator software. It requires the USB bÜS interface set available as an accessory.

Display operation: Button functions

 	Select, activate		Confirm		Back
---	------------------	---	---------	---	------

To configure the sealing function, you must switch to the detailed view "Parameter for position controller".

**How to switch to detailed view:**

→ When using Bürkert Communicator for the configuration, select **Position Controller** in the navigation area.

→ When using the display for the configuration, switch to **CONFIGURATION** on the home screen and select **Position controller**.

**How to configure the sealing function:**

→ Select **CUTOFF** in the detailed view "Parameter".

→ Select **Lower limit**.

→ Enter lower limit.

→ Select **Upper limit**.

→ Enter upper limit.

✔ You have configured the sealing function

## 14.3 Enabling – disabling correction characteristic

**Factory setting:** The correction characteristic is disabled in devices on delivery.

When the correction characteristic is enabled, the flow characteristic or operating characteristic is corrected depending on the set-point position (CMD) and valve stroke (POS).

### Flow characteristic:

The flow characteristic  $k_v = f(s)$  indicates the flow rate of a valve, expressed by the  $k_v$  value, as a function of the stroke  $s$  of the actuator spindle. The flow characteristic is determined by the shape of the valve seat and the valve seat seal. Two types of flow characteristics are generally realised: the linear and the equipercentile.

With linear characteristics, equal stroke changes are apportioned the same  $k_v$  value changes  $dk_v$ .

$$(dk_v = n_{lin} \cdot ds).$$

With equipercentile characteristics, a change in stroke  $ds$  corresponds to an equipercentile change in the  $k_v$  value.

$$(dk_v/k_v = n_{equiper} \cdot ds).$$

### Operating characteristic:

The operating characteristic  $Q = f(s)$  shows the relationship between the volume flow  $Q$  in the installed valve and the stroke  $s$ . The properties of the pipelines, pumps and consumers are included in this characteristic. The operating characteristic therefore has a different shape than the flow characteristic.

For positioning applications of controllers, special requirements are often placed on the operating characteristic, e.g. linearity. For this reason, it is occasionally necessary to correct the operating characteristic in an appropriate manner. The Type 3360 and 3361 control valve thus has a transmission joint that realises various characteristics. These characteristics are used to correct the operating characteristic.

Equipercentile characteristics 1:25, 1:33, 1:50, 25:1, 33:1 and 50:1 as well as a linear characteristic can be set. In addition, it is possible to program a user-defined characteristic by entering supporting points.

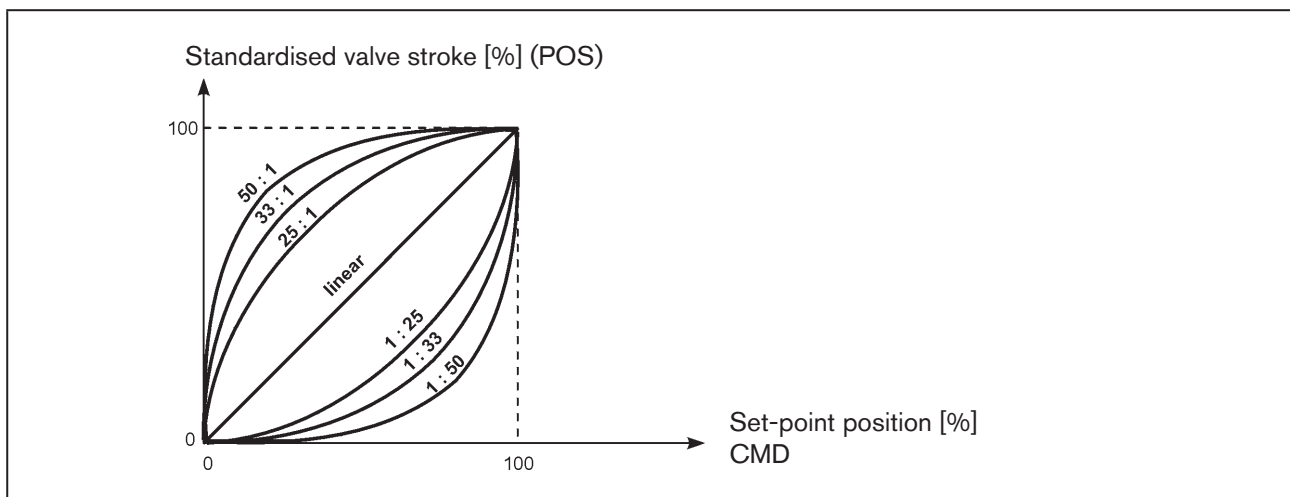

Image 41: Characteristics

### 14.3.1 Enabling or disabling correction characteristic in devices without a display module

**!** The correction characteristic must be selected for enabling. For a description see chapter [“14.3.3 Select correction characteristic or program to be user-specific”](#).

DIP switch 2, which is located under the blind cover, is used to activate the correction characteristic.

**!** **Devices with ATEX approval or IECEx approval are secured with a magnetic lock.**  
The removal of the cover is described in the supplementary instructions for the electromotive control valves with ATEX approval and IECEx approval.

→ To unlock the blind cover, turn it counterclockwise and remove

→ Set DIP switch 2 to ON. The correction characteristic is now enabled.

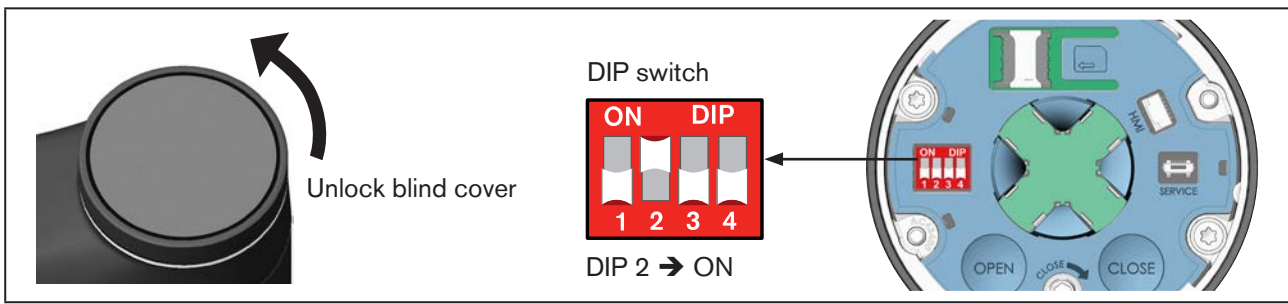

Image 42: Activate correction characteristic

→ Close the blind cover.

### 14.3.2 Enabling or disabling correction characteristic in devices with a display module

To enable or disable the correction characteristic you must switch to the detailed view “Parameter for position controller”.

**How to switch from the home screen to the detailed view:**

→ switch to **CONFIGURATION**

→ select **Position controller** and confirm selection.

You are now in the “Parameter” detailed view.

**How to enable the correction characteristic:**

→ select **ADD.FUNCTION** and confirm.

→ **Select CHARACT**, enable with the side navigation buttons and confirm.

The device returns to the “Parameter” detailed view.

The correction characteristic is enabled and the menu **CHARACT** for configuration is now available in the “Parameter” detailed view.

### 14.3.3 Select correction characteristic or program to be user-specific







#### Setting option:

Using the Bürkert Communicator software or the display of the device (optional).

Settings are created on the PC using the büS service interface and the Bürkert Communicator software. It requires the USB büS interface set available as an accessory.

Display operation: Button functions

 	Select, activate		Confirm		Back
---	------------------	---	---------	---	------

To program the correction characteristic you must switch to the “Parameter for position controller” detailed view.

#### How to switch to detailed view:

→ When using Bürkert Communicator for the configuration, select **Position Controller** in the navigation area.

→ When using the display for the configuration, switch to **CONFIGURATION** on the home screen and select **Position controller**.

#### How to select the correction characteristic:

→ Select **CHARACT** in the “Parameter” detailed view.

→ Confirm **TYPE**.

→ Select correction characteristic.

✔ You have selected the correction characteristic.

#### How to configure the user-defined correction characteristic:

if the correction characteristic **User-defined** was selected in the **TYPE** menu, the **TABLE DATA** menu appears. The correction characteristic can be programmed therein as described below:

→ **select TABLE DATA**.

→ Select desired reference point **y 0** – **y 100**.

→ Enter desired per cent value.

→ Enter the per cent in succession for all reference points.

→ Leave the **TABLE DATA** menu.

✔ You have programmed the correction characteristic.

## 14.4 Change effective direction

**Factory setting:** The effective direction "Rise" is set in devices on delivery.

Meaning:

- Rise: The position 0% (valve closed) is actuated with the standard signal 0 V, 0 mA or 4 mA.
- Fall: The position 0% (valve closed) is actuated with the standard signal 5 V, 10 V or 20 mA.

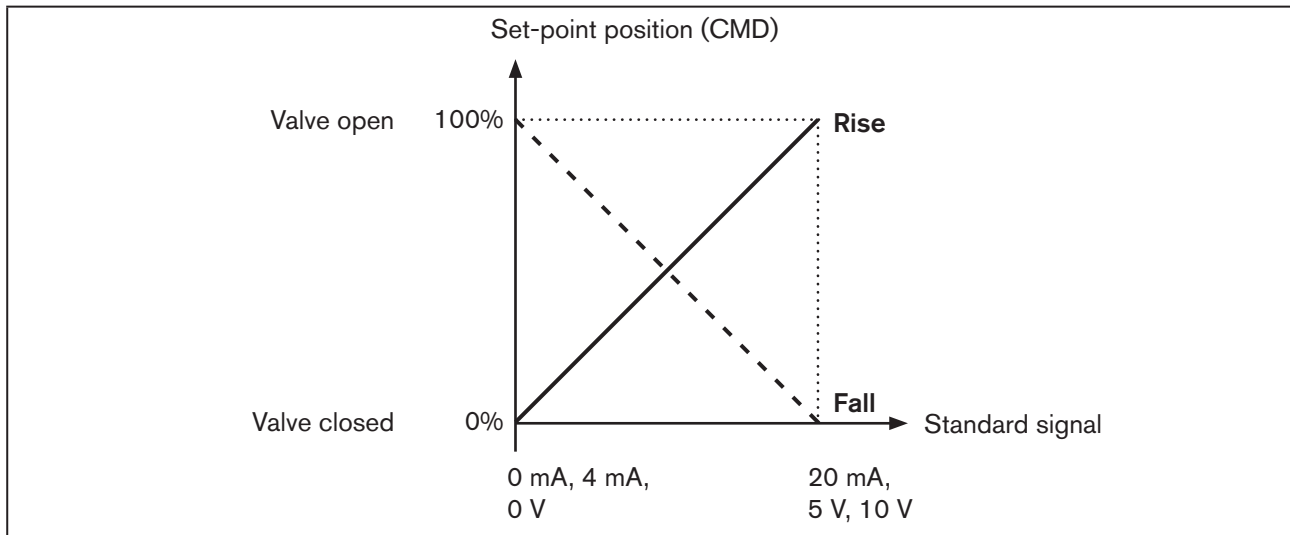

Image 43: Effective direction diagram

### 14.4.1 Changing effective direction in devices without a display module

The effective direction is changed with DIP switch 1, located below the blind cover.



**Devices with ATEX approval or IECEx approval are secured with a magnetic lock.**

The removal of the cover is described in the supplementary instructions for the electromotive control valves with ATEX approval and IECEx approval.

→ To unlock the blind cover, turn it counterclockwise and remove.

→ Set DIP switch 1 to ON. The effective direction is switched to "Fall".

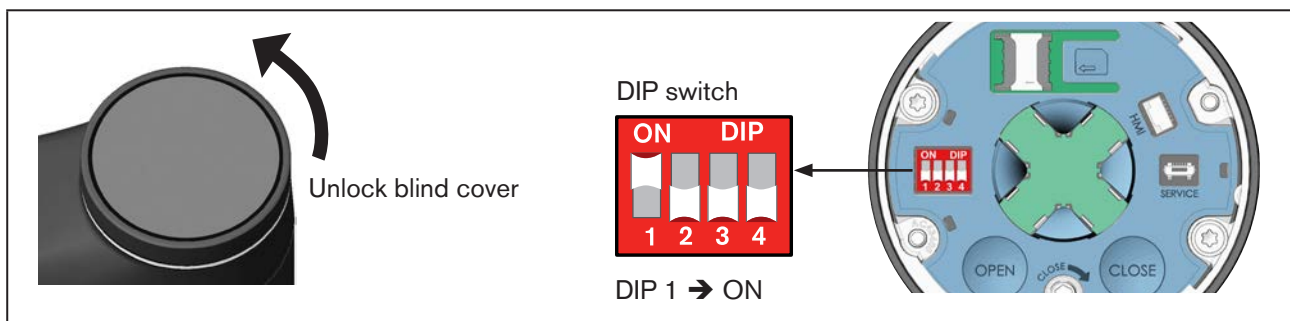





Image 44: Change effective direction





## 14.4.2 Changing effective direction in devices with a display module

To change the effective direction, you must switch to the “Parameter for position controller” detailed view.

**How to switch from the home screen to the detailed view:**





-  switch to **CONFIGURATION**
-   select **Position controller** and  confirm selection.
- ✔ You are now in the “Parameter” detailed view.

**How to change the effective direction:**

-  select **ADD.FUNCTION** and  confirm.
-  Select **DIR.DMD**, enable with the side navigation buttons  and  confirm.

The device returns to the “Parameter” detailed view.

The menu for changing effective direction **DIR.DMD** is now enabled and available in the “Parameter” detailed view.

- In the “Parameter” detailed view , select **DIR.CMD** and  confirm.
-  Select effective direction **Rise** or **Fall** and  confirm.
- Return with .
- ✔ You have changed the effective direction.

## 14.5 Disabling process control

For devices with a process control function, the process control can be disabled in order to operate the device with the position controller function. The menus that are solely relevant to process control remain visible after disabling, but cannot be used.



### Required configuration after disabling process control.

The source for the set-point position must be configured for the position controller function.  
Configuration in menu → **Inputs/outputs** → **SP I CMD** → **CMD.source**.

### 14.5.1 Disabling process control in the device operating menu

The process control is generally disabled in the device operating menu, or via the digital input, bÜS/CANopen or fieldbus.







#### Setting option:

Using the Bürkert Communicator software or the display of the device (optional).

Settings are created on the PC using the bÜS service interface and the Bürkert Communicator software. It requires the USB bÜS interface set available as an accessory.

Display operation: Button functions

 	Select, activate		Confirm		Back
---	------------------	---	---------	---	------

To scale process control, switch to the “Parameters” detailed view for process controllers.

#### How to switch to detailed view:

→ When using Bürkert Communicator for the configuration, select **Process Controller** in the navigation area.

→ When using the display for the configuration, switch to **CONFIGURATION** on the home screen and select **Process Controller**.



You are now in the “Parameter” detailed view.

#### How to disable process control:

→ **select P.CO.inactive**.

→ Select **P.CONTROL inactive**.



The process control is now disabled. The device is now working with position controller function.

### 14.5.2 Alternative disabling of process control

Alternatively, the process control can be disabled via the digital input, bÜS/CANopen or fieldbus. The source must be configured accordingly.

To configure the source, you must switch to the detailed view “Parameter for **inputs/outputs**”.

Configuration in menu → **ADDITIONAL IOs** → **DIGITAL IN** → **X.CO I P.CO.source**,

Selection:

→ **Digital** (digital input)

→ **bÜS**

→ **Fieldbus** (fieldbus)



## 15 MANUAL OVERRIDE OF VALVE

The valve can be manually actuated in various ways:

- Electrically with the OPEN and CLOSE buttons which are located under the blind cover (only on devices without display module), see chapter “15.1” on page 105.
- Electrically using the display on the home screen (only on devices with a display module), see chapter “15.2.1” on page 107.
- Electrically in the AUTO | MANU menu.  
Setting on the display or using the Bürkert Communicator software, see chapter “15.3” on page 108.
- Mechanically with the manual override, see chapter “15.4” on page 109.

### 15.1 Electrical override of valve on devices without a display module

The valve can be electrically actuated in various ways:

- with buttons in the device, see chapter “15.1.1” on page 105.
- Using the Bürkert Communicator software in the **AUTO | MANU** menu.  
For a description see chapter “15.3” on page 108.

#### 15.1.1 Electrically actuating the valve using keys in the device

##### NOTE!

Valve seat seal may be damaged as a result of electrical manual override.

- ▶ Do not press the CLOSE button while the valve is closed or else the valve seat seal may be damaged.

To actuate the valve, the device must be in MANUAL operating state.

The 2 buttons for actuating the valve and for setting the mode are located under the blind cover.

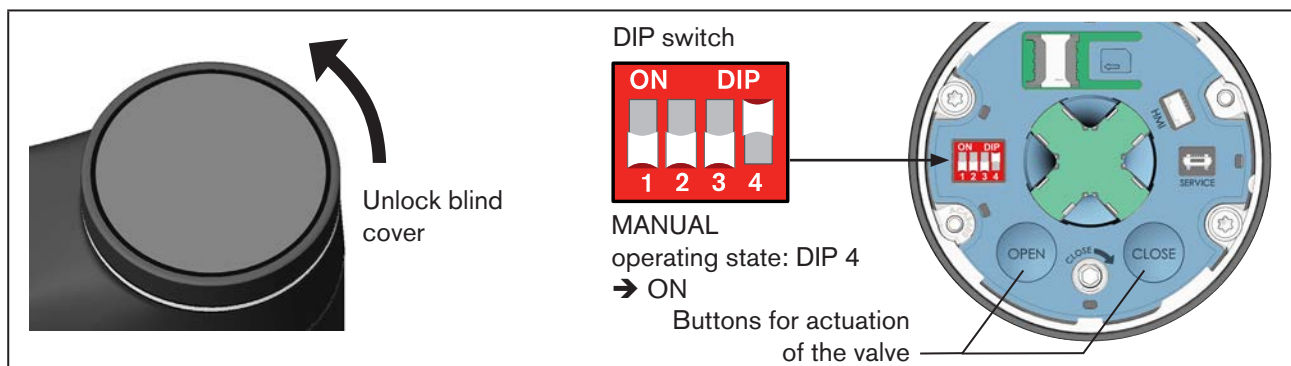

Image 45: Set MANUAL operating state and actuate valve

**Remove the blind cover:**



**Devices with ATEX approval or IECEx approval are secured with a magnetic lock.**

The removal of the cover is described in the supplementary instructions for the electromotive control valves with ATEX approval and IECEx approval.

→ To unlock the blind cover, turn it counterclockwise and remove.

**Switch to MANUAL operating state:**

→ Set DIP switch 4 to ON.

The device is in MANUAL operating state.

**Change valve position:**

→ To open, press the OPEN button

→ To close, press the CLOSE button.

**NOTE!**

Do not press the CLOSE button again while the valve is closed or else the valve seat seal may be damaged.

The valve position is to be detected on the mechanical position indicator.

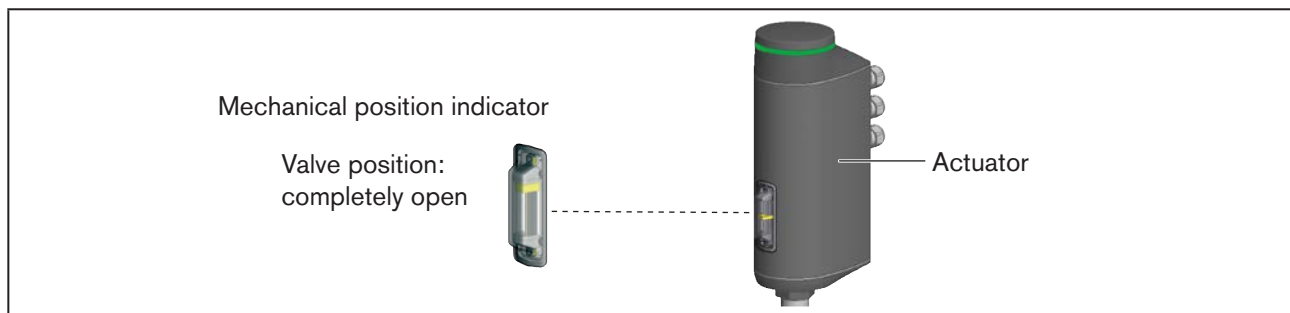

Image 46: Mechanical position indicator

**Switch to AUTOMATIC operating state:**

→ Push DIP switch 4 down.

The device is back in AUTOMATIC operating state.

**Close blind cover:**

→ Mount blind cover and turn clockwise until the 2 marks (one vertical line on the blind cover and on the actuator) are vertically aligned.

## 15.2 Electrical override of valve on devices with a display module

The valve can be electrically actuated in various ways:

- using the navigation keys on the display (see chapter “15.2.1” on page 107).
- On the display or using the Bürkert Communicator software in the **AUTO | MANU** menu. For a description see chapter “15.3” on page 108.

### 15.2.1 Actuating the valve using the navigation keys on the display

#### NOTE!

**Valve seat seal may be damaged as a result of electrical manual override.**

- ▶ Do not press the CLOSE button while the valve is closed or else the valve seat seal may be damaged.

The navigation keys for actuating the valve are available in the home screen or in a view. Requirements for actuation of the valve: (see “Image 47”):

- View of the display in the MANU/AUTO layout,
- MANUAL operating state.



#### Setting the layout:

The layout settings are created in the context menu: To open the context menu, hold down the menu key .

#### MANU/AUTO layout factory setting:

The MANU/AUTO layout is pre-defined in factory settings for the home screen (factory designation: View 1...).

To access the home screen, hold down the  back key.

See also chapter “13.3 Display views” on page 85.

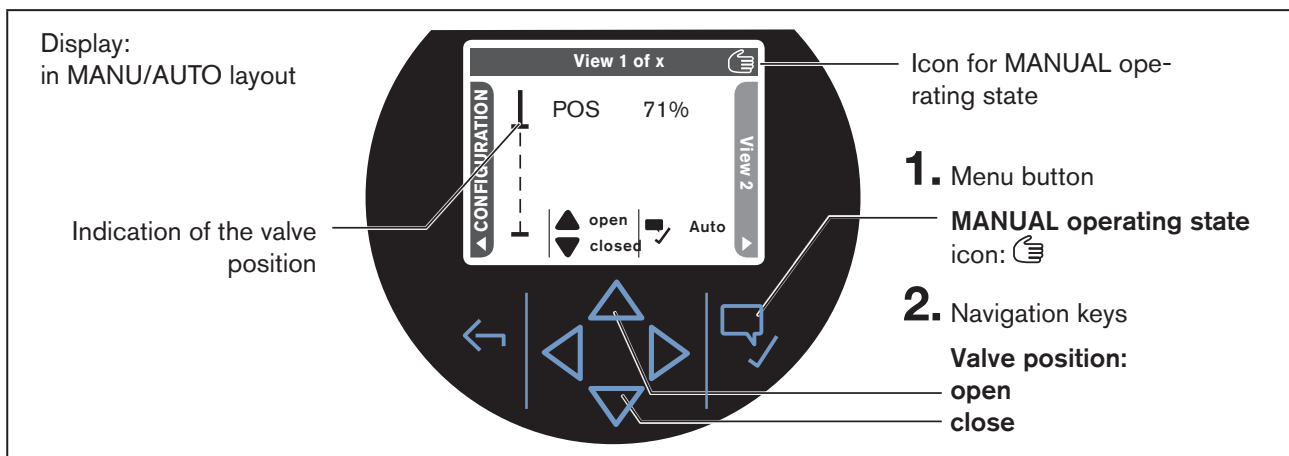





Image 47: On the display set the mode and actuate the valve

**Switch to MANUAL operating state:**

-  Press the menu button.  
In MANUAL operating state, the MANUAL icon  is visible in the information bar.  
The two arrow icons labelled “open” and “close” are displayed. The device's LED light ring flashes.

**Change valve position:**

- To open the valve,  press the top navigation key.
- To close the valve,  press the bottom navigation key.  
**NOTE!** Do not press the CLOSE button again while the valve is closed or else the valve seat seal may be damaged.

The valve position is shown on the display (see “Image 47”).

**Switch to AUTOMATIC operating state:**

- To switch to AUTOMATIC operating state, briefly press the  menu button.

## 15.3 Electrically actuating the valve using the Bürkert Communicator or display

**NOTE!**



**Valve seat seal may be damaged as a result of electrical manual override.**

- ▶ Do not press the CLOSE button while the valve is closed or else the valve seat seal may be damaged.

Both the Bürkert Communicator software as well as the device software provide the additional option to actuate the valve using the **AUTO | MANU** menu.

 For the setting using the Bürkert Communicator software, the device must be connected to the PC using the bÜS service interface. It requires the USB bÜS interface set available as an accessory.

Display operation: Button functions

 Select, activate	 Confirm	 Back
--	---	--

**Actuate the valve using the **AUTO | MANU** menu:**

To configure, you must switch to the detailed view “Maintenance for general settings”.

How to switch to detailed view:

- When using Bürkert Communicator for the configuration, select **General settings** in the navigation area and switch to **MAINTENANCE**.
- When using the display for the configuration, switch to **CONFIGURATION** on the home screen, select **General settings** and switch to **MAINTENANCE**.
- ✔ You are now in the “Maintenance” detailed view.

How to open or close the valve:

→ **select AUTO | MANU.**

If the device is in AUTOMATIC operating state:

→ select **Manual mode** to set MANUAL operating state.

The **Manual mode** menu for manual actuation of the valve is now available.

→ In the **Manual mode** menu, open and close the valve with the arrow buttons.

**NOTE!**

Do not press the CLOSE button again while the valve is closed or else the valve seat seal may be damaged.

## 15.4 Actuating the valve mechanically

If the supply voltage is not applied, e.g. during installation or in the event of a power failure, the valve position can be changed using the mechanical manual override.

**NOTE!**

The mechanical manual override may be used only when it is de-energised, otherwise the device may be damaged.

### 15.4.1 Required work steps

**Devices without fieldbus gateway:**

1. Switch off the supply voltage. Wait until LED illuminated ring goes out.
2. Remove blind cover or display module, chapter "[15.4.3](#)" on page 110.
3. Actuate the valve mechanically, chapter "[15.4.5](#)" on page 112.
4. Close blind cover or display module, chapter "[15.4.7](#)" on page 114.
5. Connect supply voltage.

**Devices with fieldbus gateway:**

1. Switch off the supply voltage. Wait until LED illuminated ring goes out.
2. Remove blind cover or display module, chapter "[15.4.3](#)" on page 110.
3. Remove fieldbus gateway from actuator, chapter "[15.4.4](#)" on page 111.
4. Actuate the valve mechanically, chapter "[15.4.5](#)" on page 112.
5. Mount fieldbus gateway on actuator, chapter "[15.4.6](#)" on page 113.
6. Close blind cover or display module, chapter "[15.4.7](#)" on page 114.
7. Connect supply voltage.

### 15.4.2 Required tool

- Allen key, width across flats 3 mm

### 15.4.3 Remove blind cover or display module

#### NOTE!

Carefully remove the display module so that the connection cable and HMI interface are not damaged.



**Devices with ATEX approval or IECEx approval are secured with a magnetic lock.**

The removal of the cover is described in the supplementary instructions for the electromotive control valves with ATEX approval and IECEx approval.

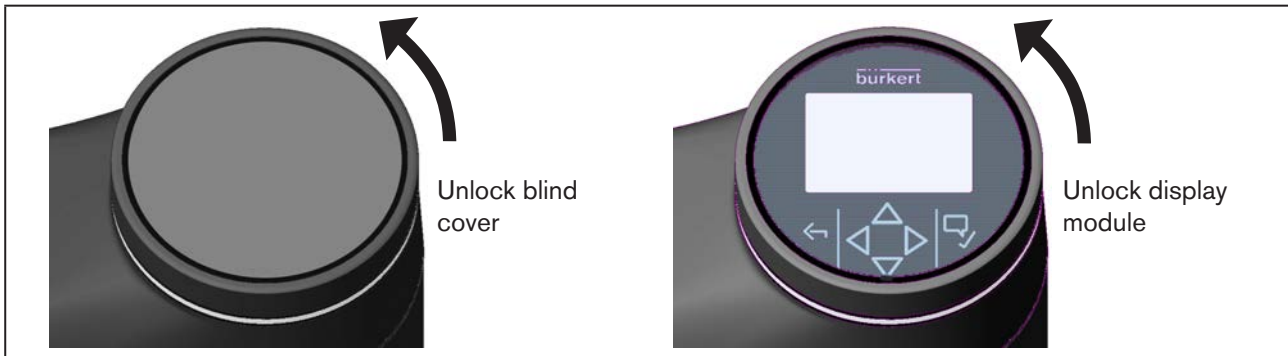

Image 48: Remove blind cover or display module

→ To unlock, turn the display module or the blind cover counterclockwise and remove.



For devices with display module, take note of the connection cable to the HMI interface.

## 15.4.4 Removing the fieldbus gateway from the actuator

### Preconditions:

Supply voltage switched off, blind cover or display module removed.

### NOTE!

The fieldbus gateway may be removed only when it is deenergised, otherwise the device may be damaged.

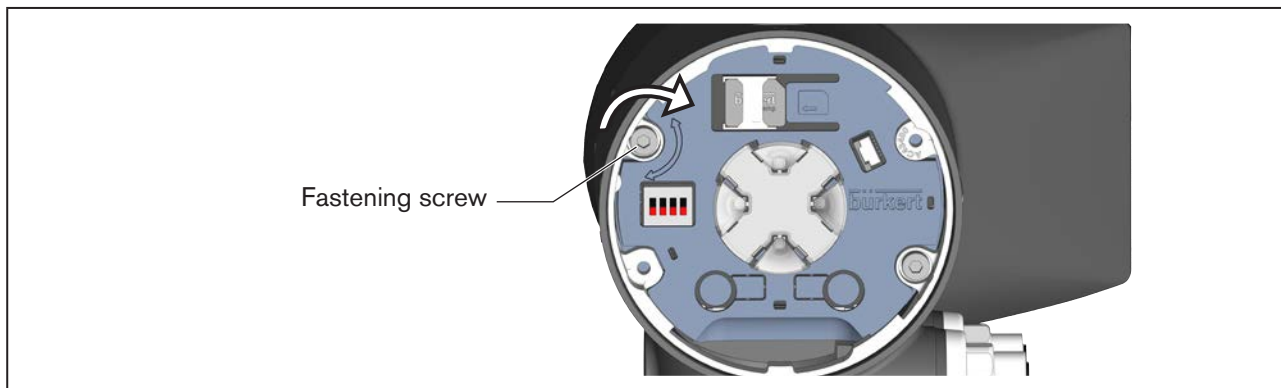

Image 49: Remove fieldbus gateway

→ Remove fastening screw (socket head screw, width across flats 3 mm).

### NOTE!

Caution when removing the fieldbus gateway. Fieldbus gateway and actuator are connected to each other by a cable.

→ To release the fieldbus gateway, turn it counterclockwise and carefully remove it.

→ Disconnect connection cable from the fieldbus gateway.

### 15.4.5 Actuating the valve mechanically

**Preconditions:**

Supply voltage switched off, blind cover or display module removed. Also for device variant with fieldbus gateway: Fieldbus gateway removed.

**NOTE!**

The mechanical manual override may be used only when it is de-energised, otherwise the device may be damaged.

→ To mechanically override the valve, use an Allen key with 3 mm AF.

**NOTE!**

**Maximum torque 2 Nm.**  
Exceeding this torque value upon reaching the end position of the valve may damage the mechanical manual override mechanism.

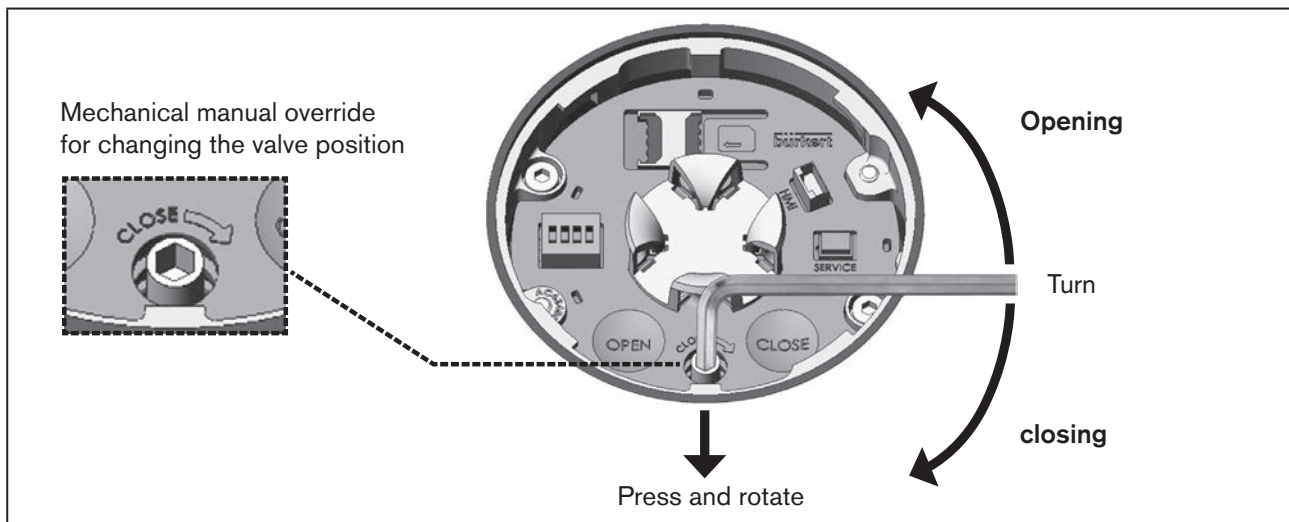

Image 50: Mechanical manual override

→ Apply light pressure to lock the mechanical manual override mechanism into place while turning the Allen key (see "Image 50").

- ⚠ Maximum tightening torque 2 Nm
- Turn counterclockwise to open.
- Turn clockwise to close.

The valve position is to be detected on the mechanical position indicator.

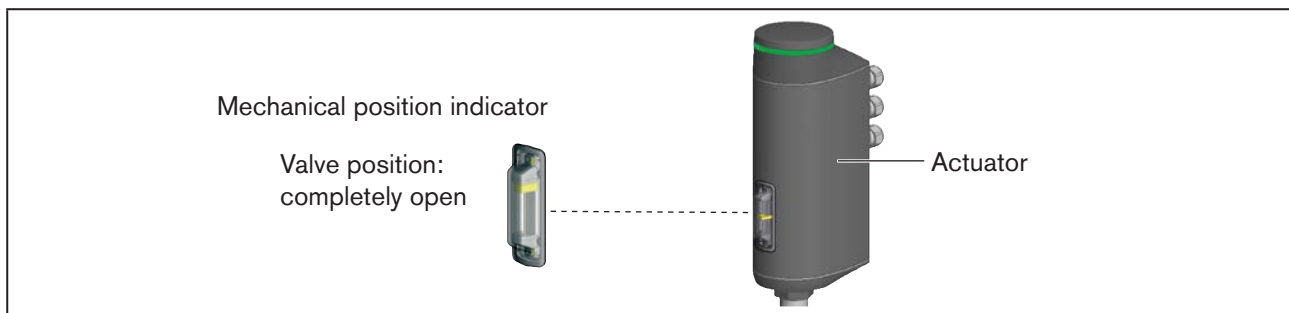

Image 51: Mechanical position indicator

MAN 1000274112 EN Version: G Status: RL (released | freigegeben) printed: 28.05.2021



- Once the desired valve position is achieved, remove the Allen key.  
The mechanical manual override mechanism will disengage automatically.

### 15.4.6 Mounting the fieldbus gateway on the actuator

Preconditions: Supply voltage switched off.

#### NOTE!

The fieldbus gateway may be mounted only when it is deenergised, otherwise the device may be damaged.

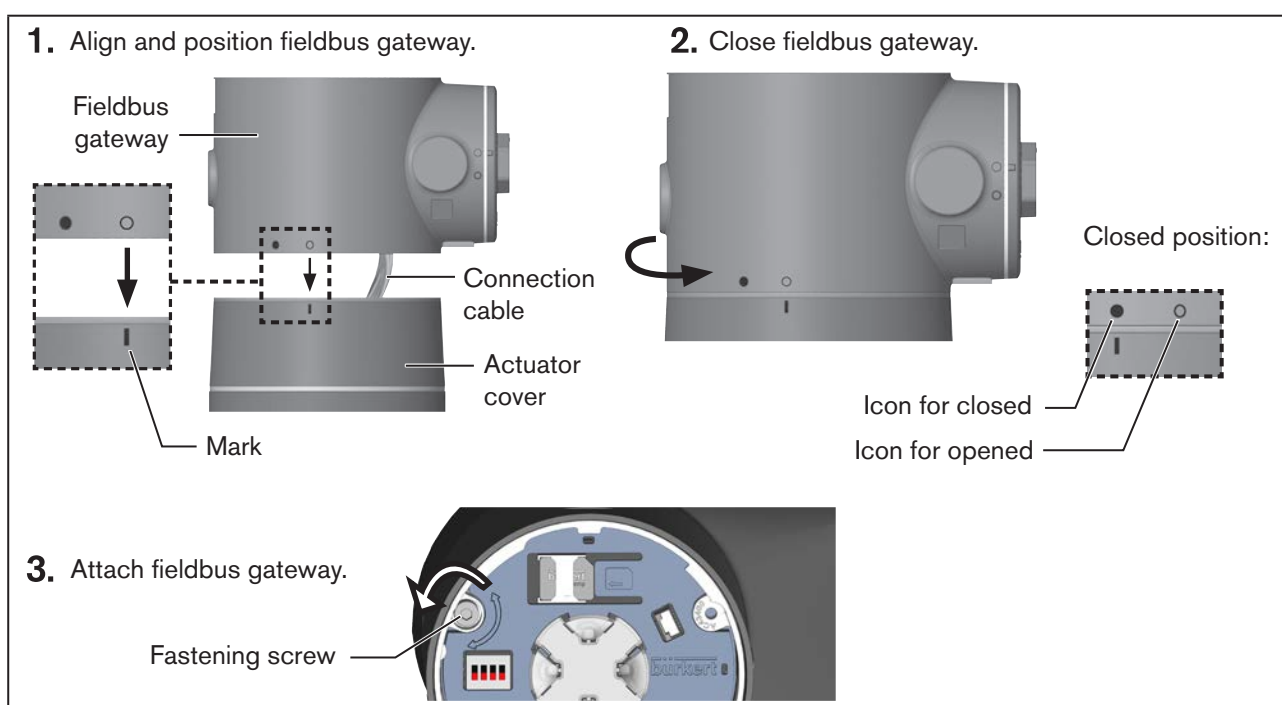

Image 52: Mounting fieldbus gateway:

- Insert connection cable into the actuator on the fieldbus gateway.
- Align and position fieldbus gateway on the actuator cover.  
Centre the icon for opened over the mark on the actuator.
- Manually turn fieldbus gateway clockwise until the icon for closed is positioned over the mark.
- Tighten fastening screw (socket head screw, width across flats 3 mm).  
Observe the tightening torque of 1.1 Nm!

### 15.4.7 Close the blind cover or display module



**Devices with ATEX approval or IECEx approval are secured with a magnetic lock.**

Closing the cover is described in the supplementary instructions for the electromotive control valves with ATEX approval and IECEx approval.

#### **NOTE!**

##### **For devices with display module**

Before mounting the display, check whether the cable is correctly connected to the HMI interface.

→ Mount display module or the blind cover and turn it clockwise until the 2 marks are vertically aligned. Vertical lines are affixed as marks to the display module, blind cover and actuator.

## 16 ADVANCED FUNCTIONS

The functions for special control tasks and their configuration are described in a separate software description. These can be found, with specification on our homepage: [country.burkert.com](http://country.burkert.com)

# 17 OPERATING STRUCTURE AND FACTORY SETTING

The factory default settings are depicted in blue in the operating structure to the right of the menu.

- Examples:  /  Factory-enabled or selected menu options  
 /  Factory-disabled or unselected menu options  
 2%, 10 sec, ... Factory-set values

## 17.1 Operating structure of the configuration area

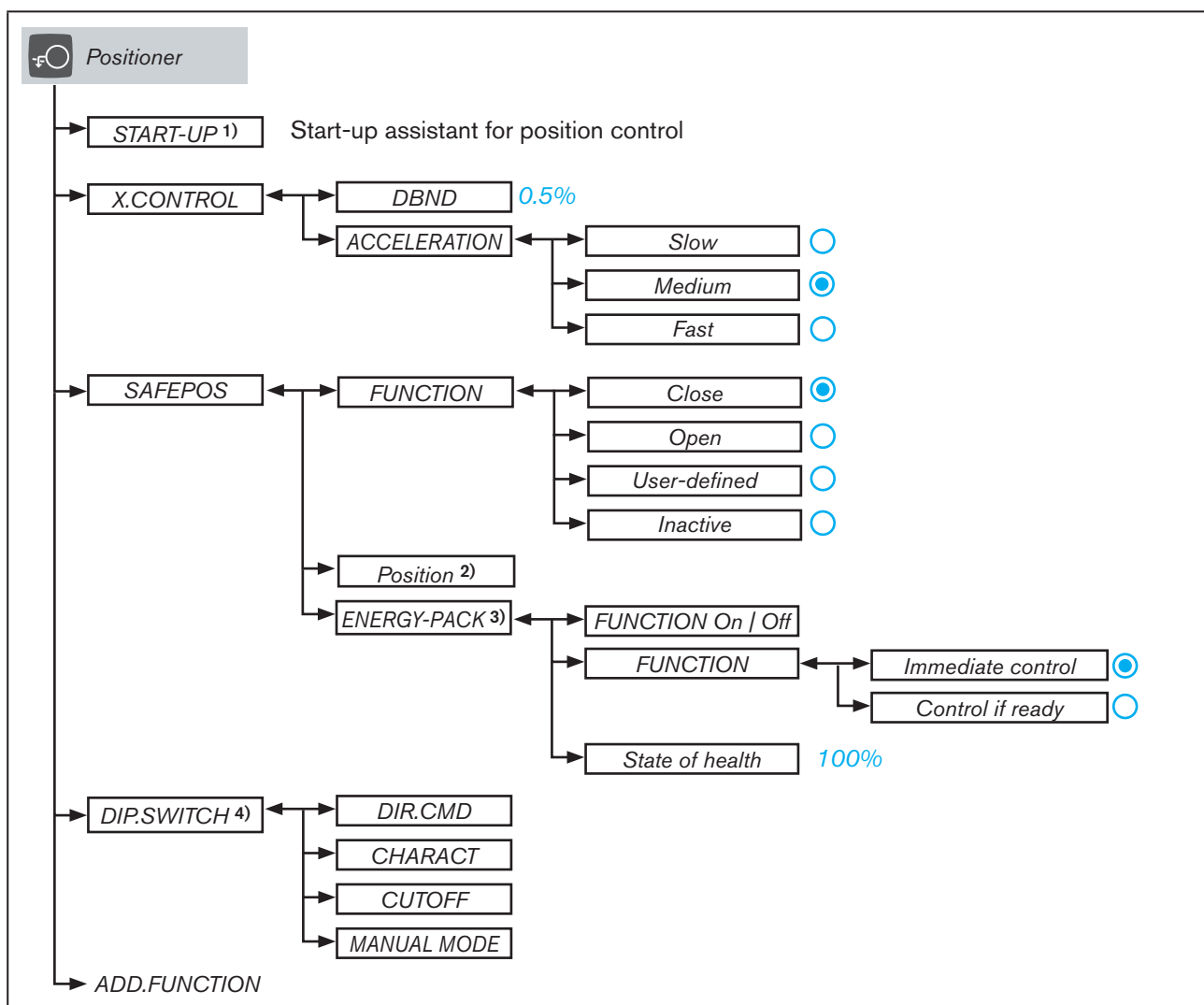

Image 53: Operating structure – 1-a, "Positioner" configuration area

- 1) Only available in devices without process controller function
- 2) Only available if selected in the menu **SAFEPOS** → **FUNCTION** → **User-Defined**.
- 3) Only available in devices with energy storage system SAFEPOS energy-pack (option).
- 4) Only available in the Bürkert Communicator software for devices without a display module.

MAN 1000274112 EN Version: G Status: RL (released | freigegeben) printed: 28.05.2021

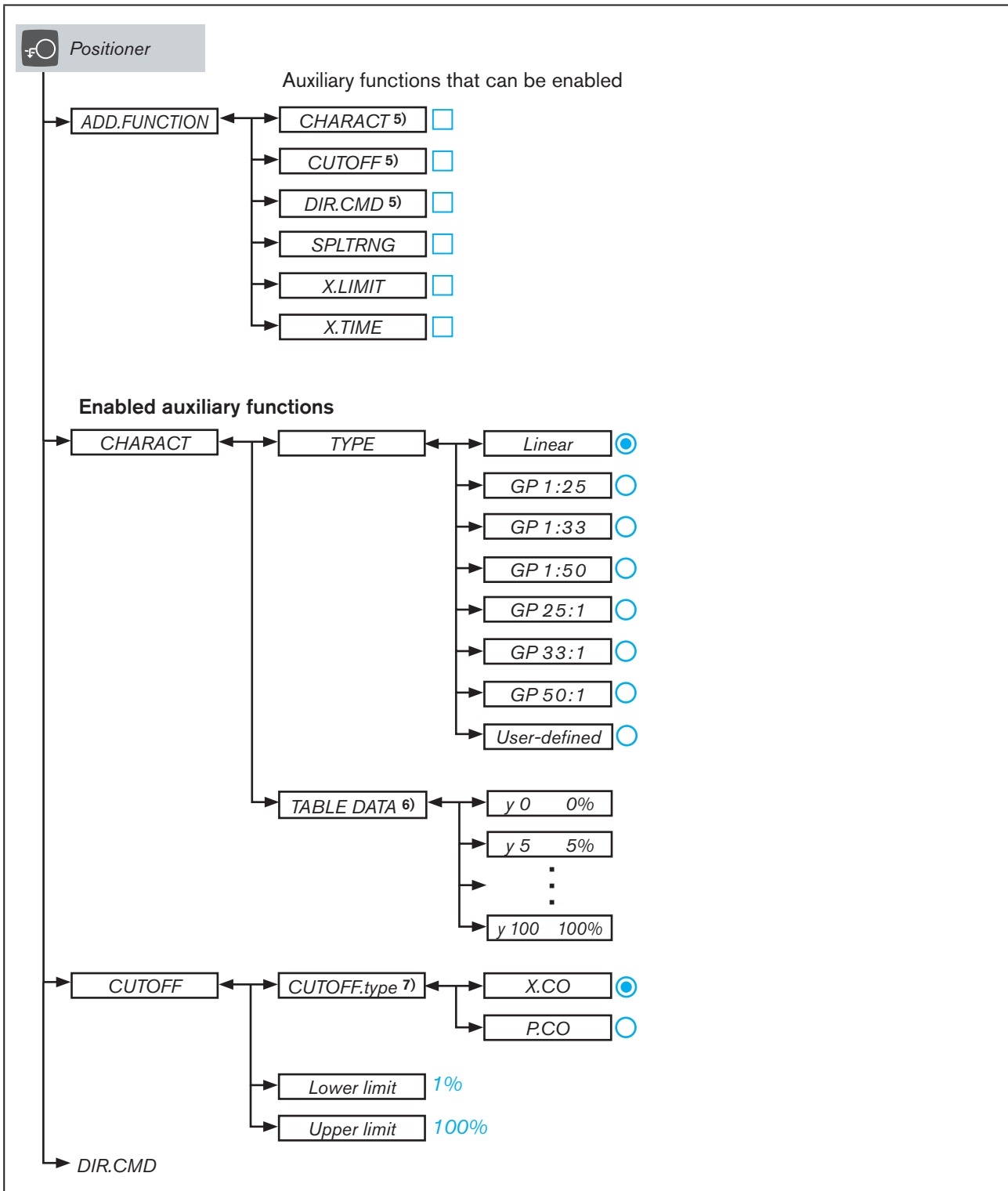

Image 54: Operating structure – 1-b, "Position controller" configuration area

5) For devices without a display, the menu is not enabled with **ADD.FUNCTION** but rather on the DIP switch of the device

6) Only available if selected in the menu **CHARACT** → **TYPE** → **User-Defined**.

7) Only available in devices with process control function.

MAN 1000274112 EN Version: G Status: RL (released | freigegeben) printed: 28.05.2021

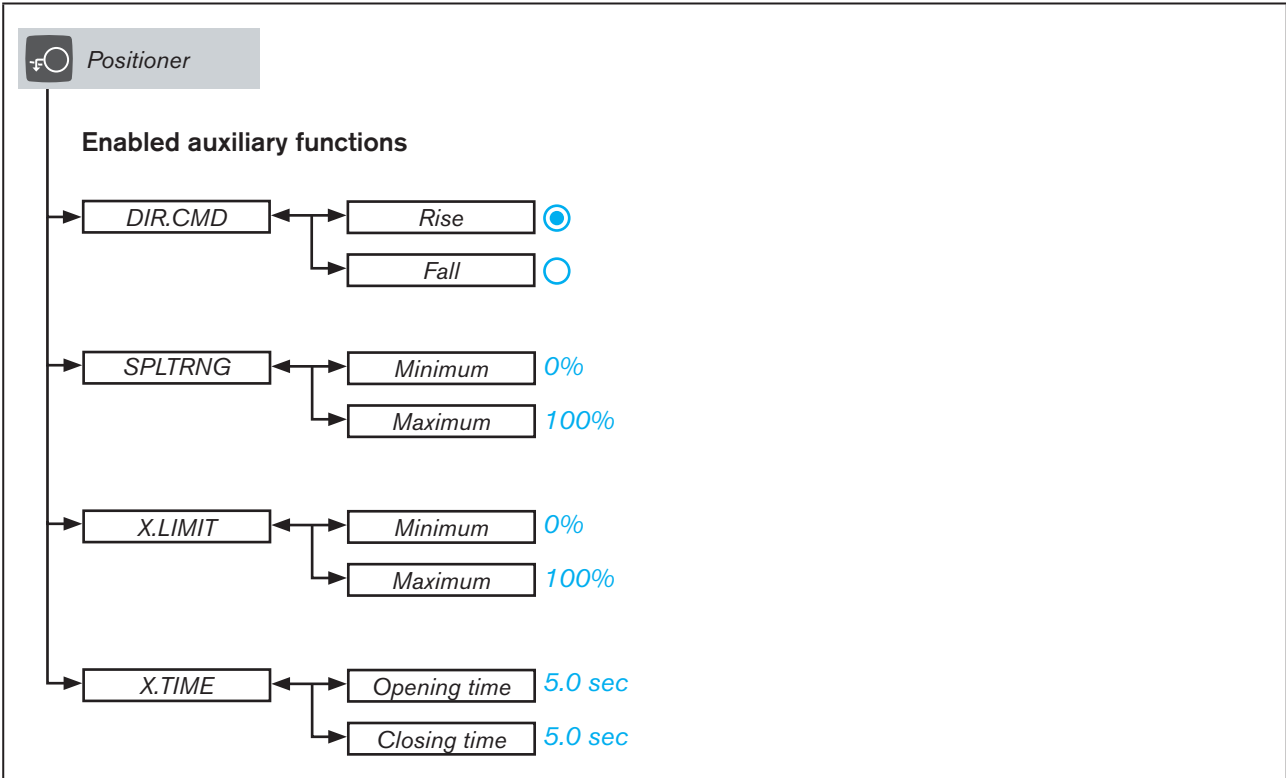

Image 55: Operating structure – 1-c, "Position controller" configuration area

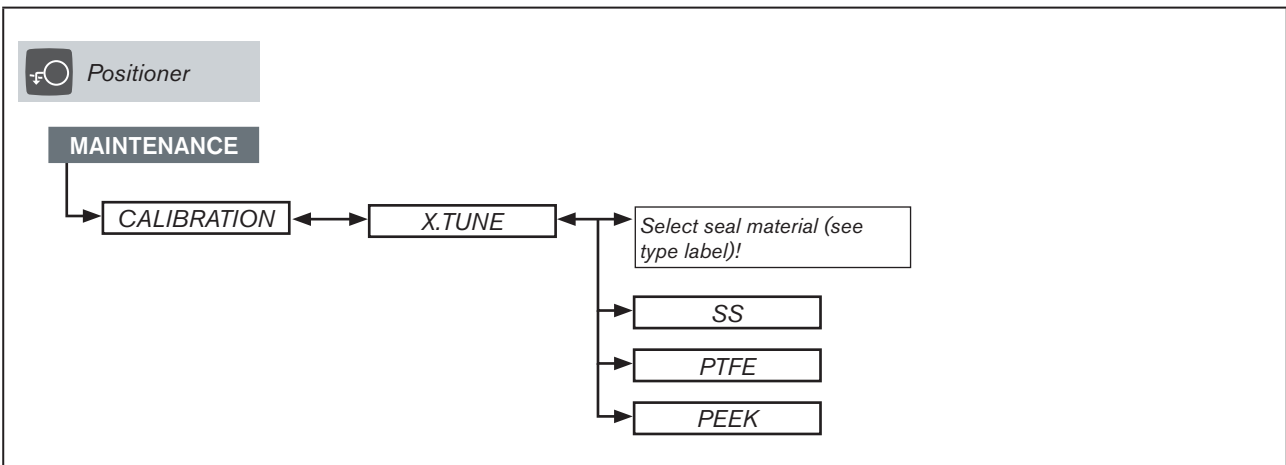

Image 56: Operating structure – 1-d, position controller maintenance

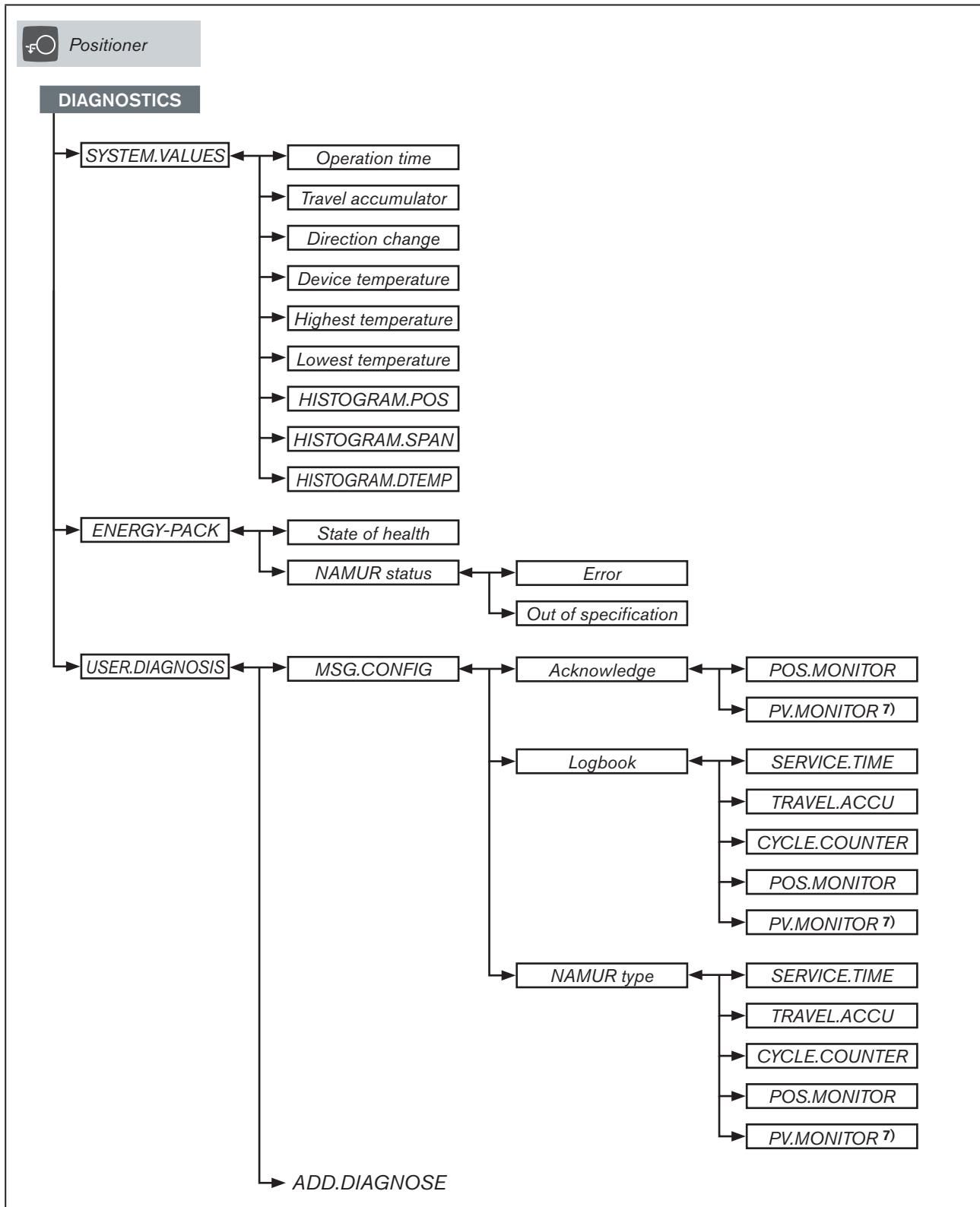

Image 57: Operating structure – 1-e, position controller diagnostics

7) Only available in devices with process control function.

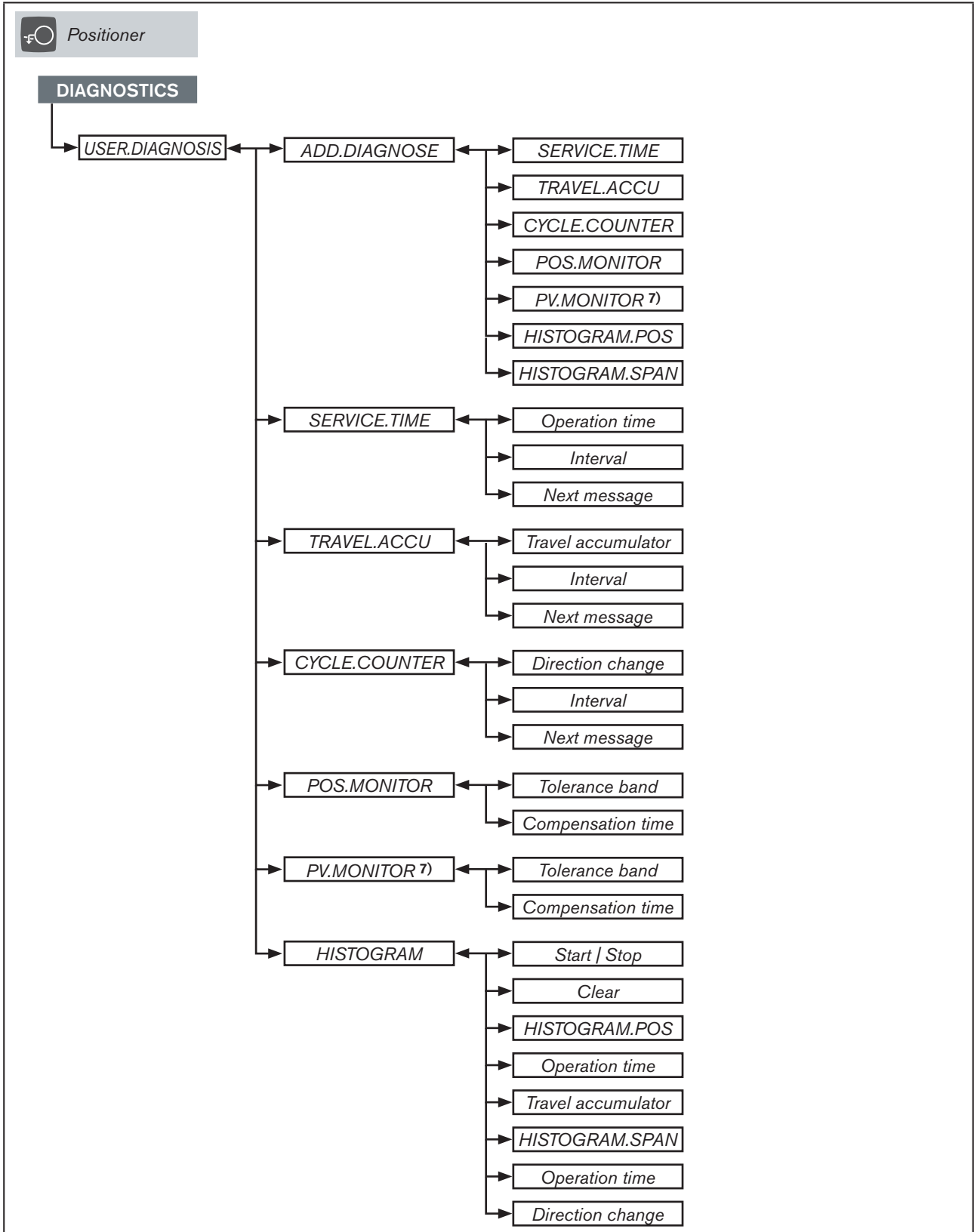

Image 58: Operating structure – 1-f, position controller diagnostics

7) Only available in devices with process control function.

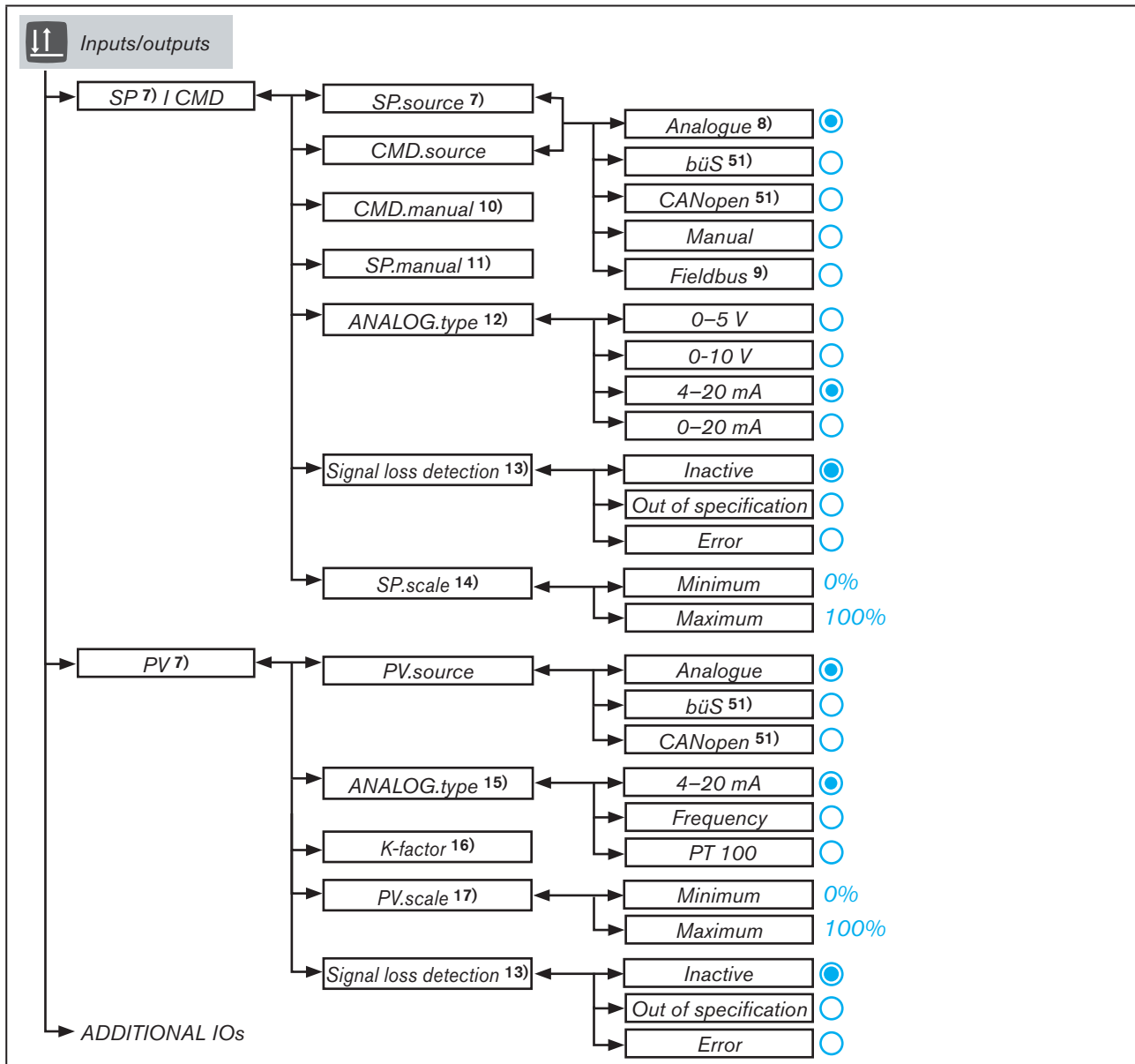

Image 59: Operating structure – 2-a, “Inputs/outputs” configuration area

7) Only available in devices with process control function.

8) Not available in devices with gateway option.

9) Only available in devices with gateway option.

10) Only available if selected in the menu **CMD.source** → **Manual**.

11) Only available in devices with process control function if selected in menu **SP | CMD** → **SP.source** → **Manual**.

12) Only available if selected in the menu **CMD.source** or in menu **SP.source** → **Analog**.

13) Only available if selected in submenu → **ANALOG.type** → **4-20 mA**.

14) Only available in devices with process control function if selected in menu **SP | CMD** → **SP.source** → **Analog**.

15) Only available if selected in the menu **PV.source** → **Analog**.

16) Only available if selected in the menu **PV** → **Analog.type** → **Frequency**.

17) Only available if selected in the menu **PV** → **Analog.type** → **4-20 mA**.

51) Only available in devices with corresponding protocol



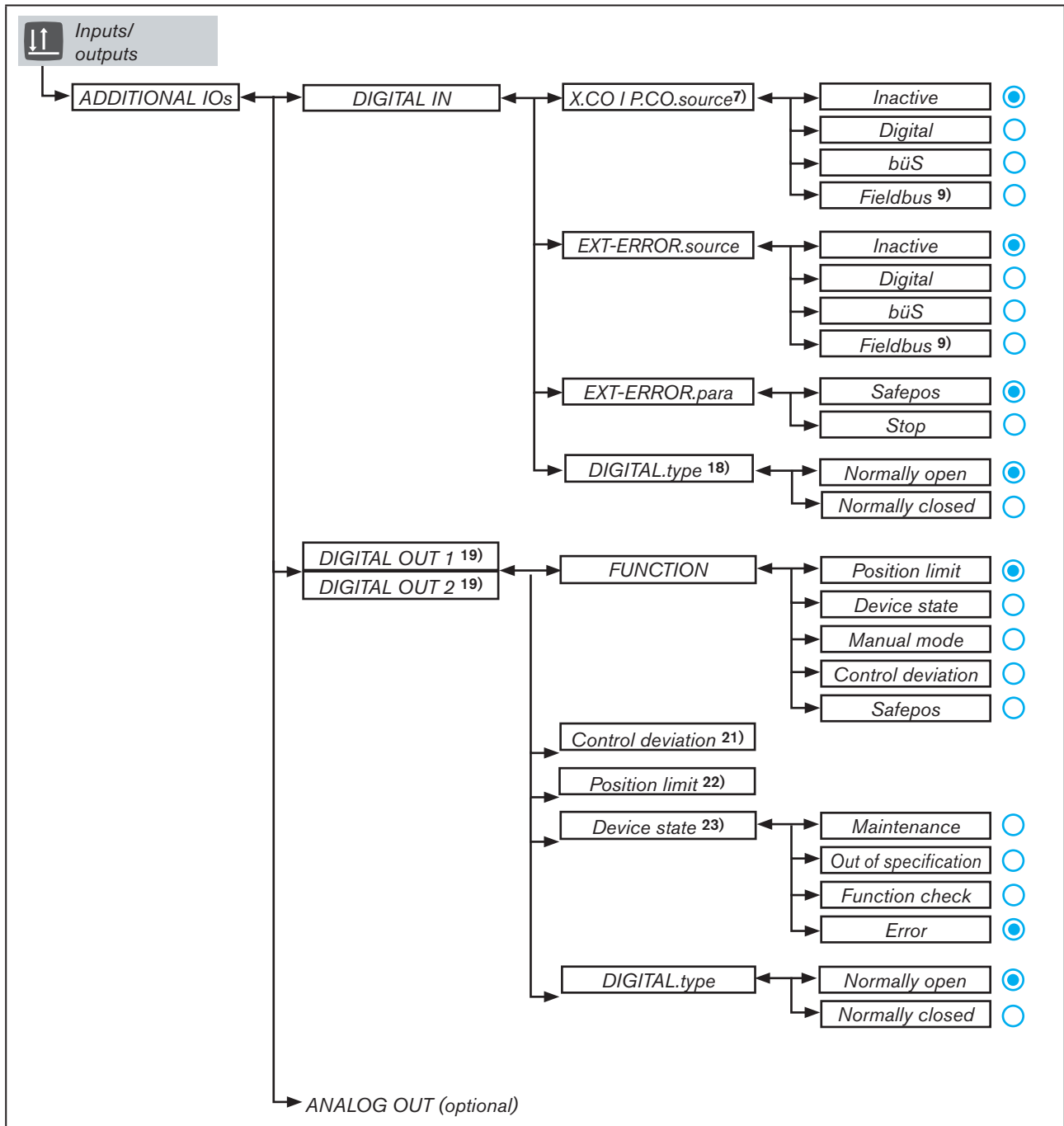

Image 60: Operating structure – 2-b, "Inputs/outputs" configuration area

7) Only available in devices with process control function

9) Only available in devices with gateway option.

18) Only available if selected in the menu **ADDITIONAL IO's** → **DIGITAL IN** → **X.CO I P.CO.source** or **EXT-ERROR.source** → **Digital**.

19) Only available in devices with digital output option.

21) Only available if selected in submenu **FUNCTION** → **Control Deviation**.

22) Only available if selected in submenu **FUNCTION** → **Position Limit**.

23) Only available if selected in submenu **FUNCTION** → **Device State**.

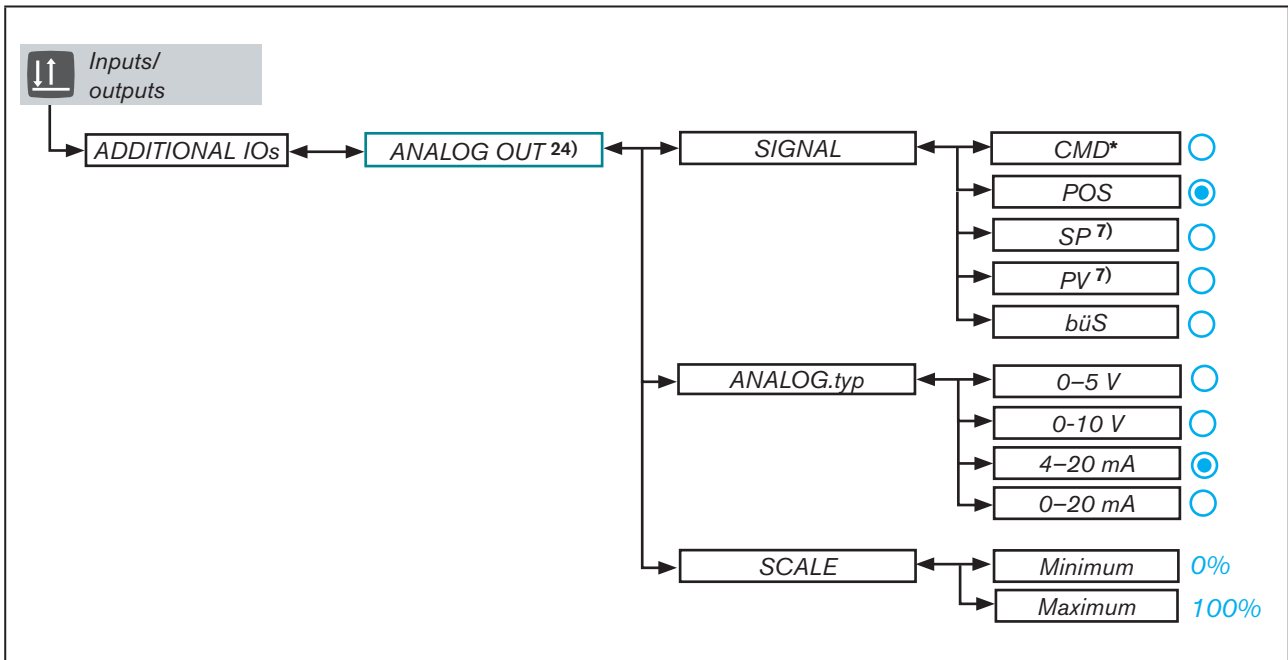

Image 61: Operating structure – 2-c, “Inputs/outputs” configuration area

MAN 1000274112 EN Version: G Status: RL (released | freigegeben) printed: 28.05.2021

7) Only available in devices with process control function

24) Only available in devices with analogue output option.

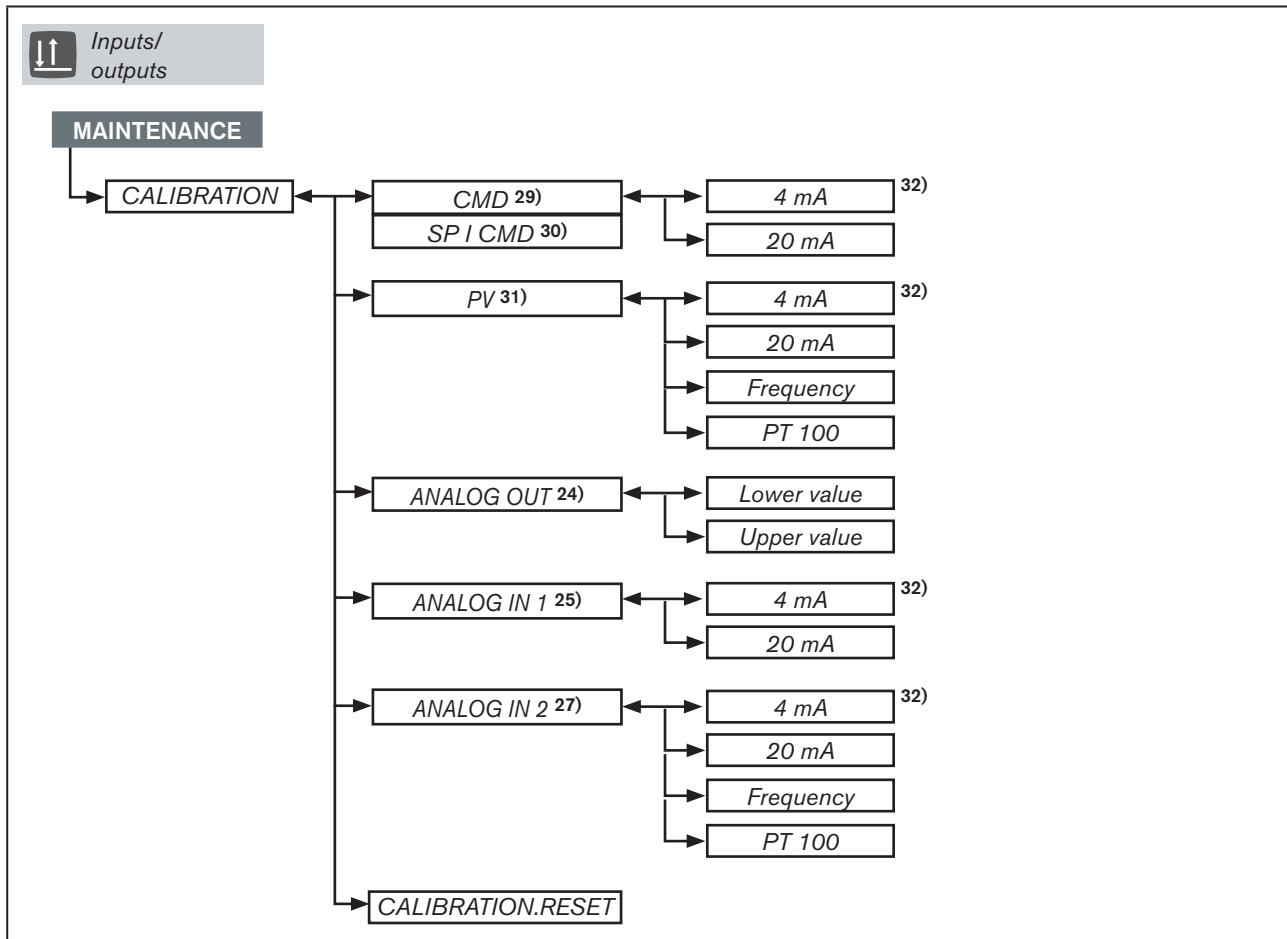

Image 62: Operating structure – 2-d, inputs/outputs maintenance



The “Industrial Communication” configuration area is only available in devices equipped with a fieldbus gateway.  
The Industrial Communication menu is described in the separate software manual.

**Download at:** [www.burkert.com](http://www.burkert.com) / Type 3360, 3361 / Downloads “Operating instructions” / Software manual Type 3360.

Image 63: Operating structure – 3, Industrial communication

24) Only available in devices with analogue output option.

25) Only available in devices with position controller function if selected in menu **CMD** → **CMD.source** → **büS** or **Manual**.

in devices with position controller function if selected in menu **SP I CMD** → **CMD.source** and **SP.source** → **büS** or **Manual**. Not available in devices with gateway option.

27) Only available in devices with process control function if selected in menu **PV** → **PV.source** → **büS**.

29) Only available in devices with position controller function if selected in menu **CMD** → **CMD.source** → **Analog**.

30) Only available in devices with process control function if selected in menu **SP I CMD** → **CMD.source** or **SP.source** → **Analog**.

31) Only available in devices with process control function if selected in menu **PV** → **PV.source** → **Analog**.

32) The display depends on the set input signal → **Inputs/outputs** → Menu **ANALOG.type** or **TYPE**.

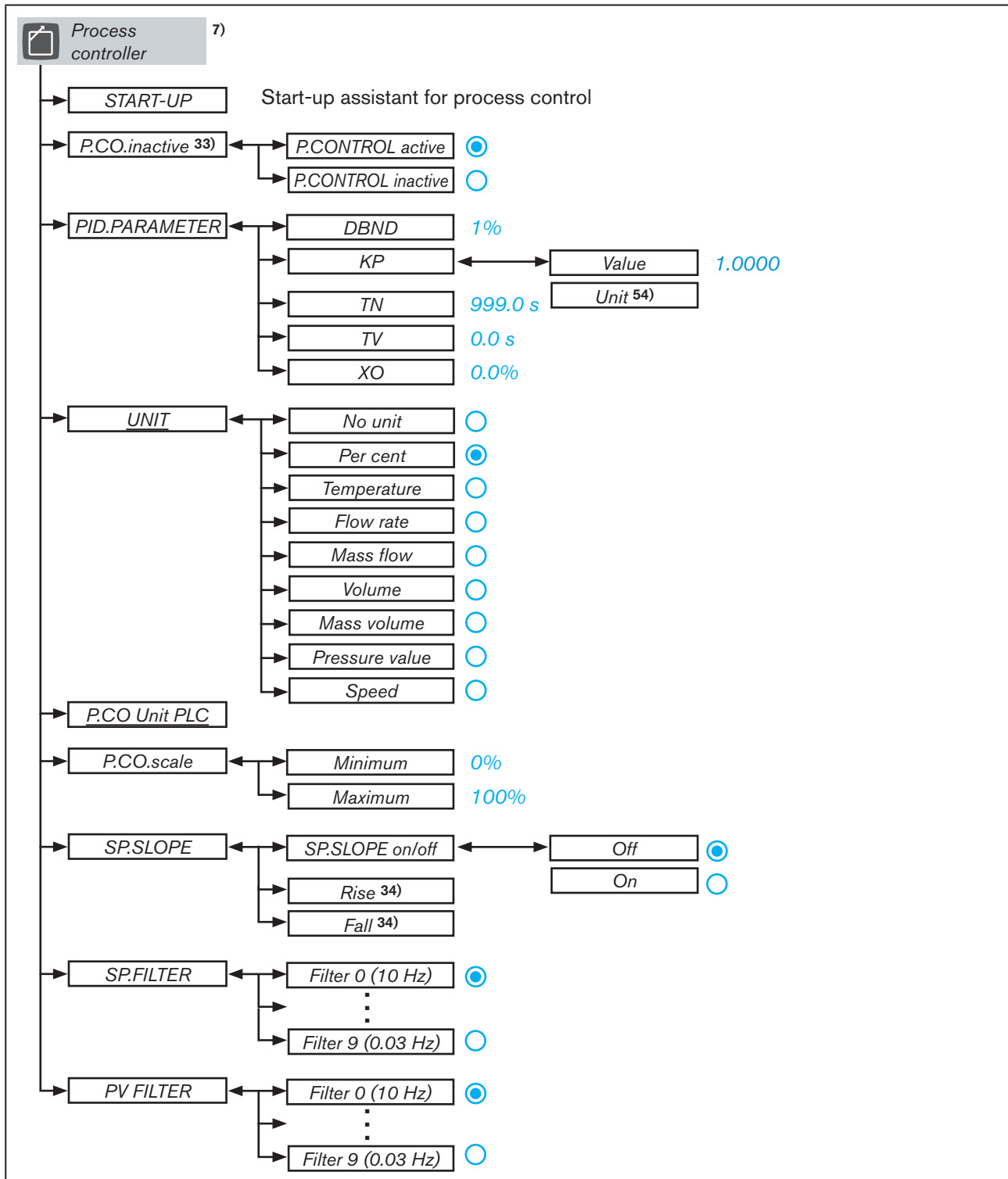

Image 64: Operating structure – 3-a, “Process controller” configuration area

7) Only available in devices with process control function.

33) Not available if the setting is made via the digital input, büS/CANopen or fieldbus. Setting: **Inputs/outputs** → **DIGITAL IN** → **X.CO I** **P.CO.source**.

34) Only available if selected in the menu **SP.SLOPE** → **SP.SLOPE on/off** → **On**.

54) Not available if selected in menu **UNIT** → **No unit** or **per cent**.

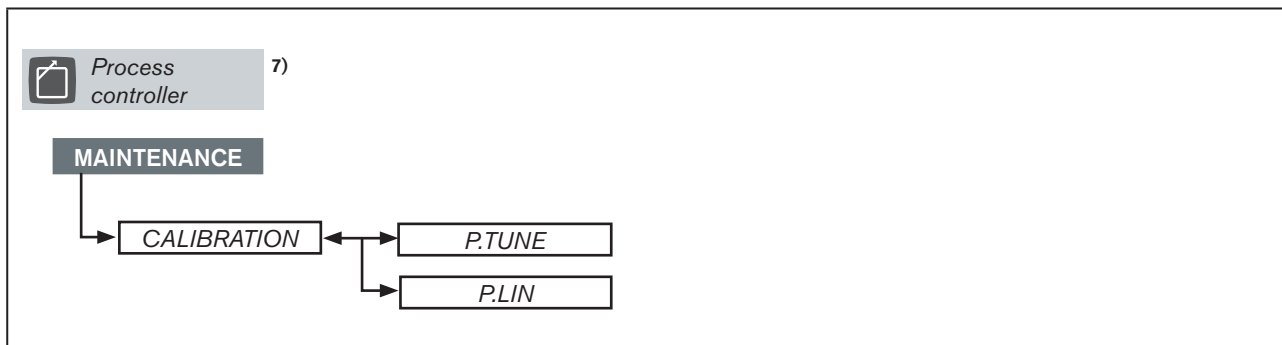

Image 65: Operating structure – 3-b, process controller maintenance

7) Only available in devices with process control function.

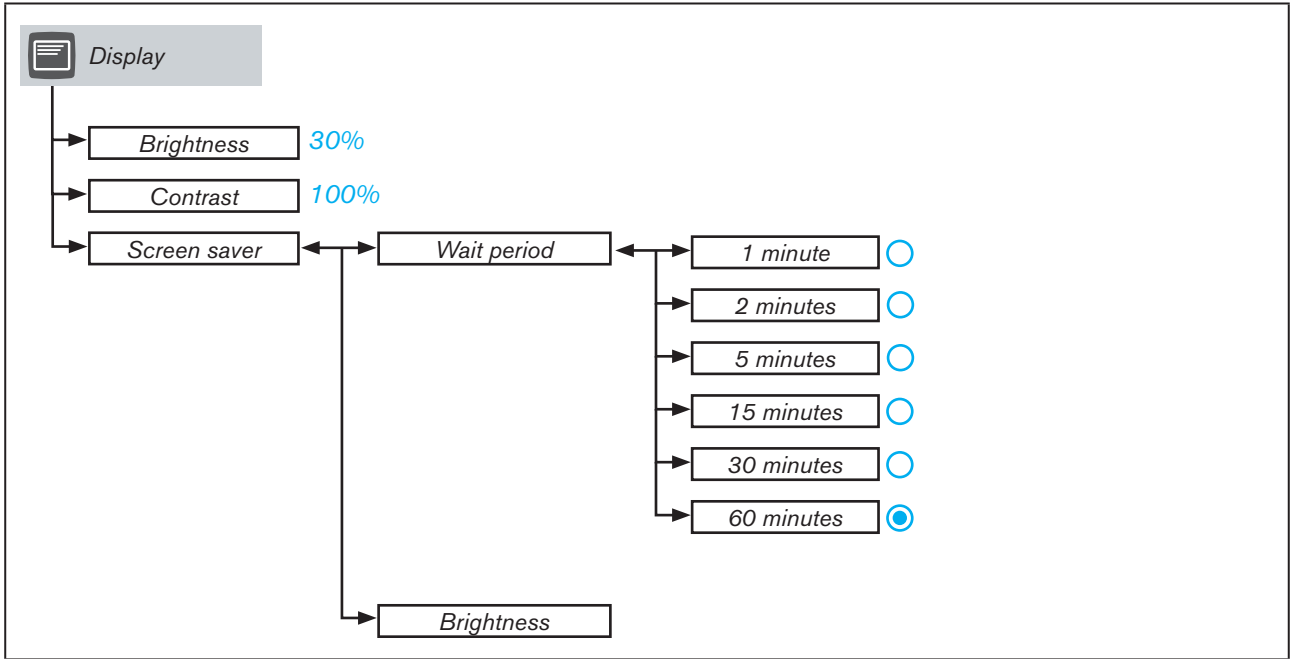

Image 66: Operating structure – 4-a, “Display” configuration area

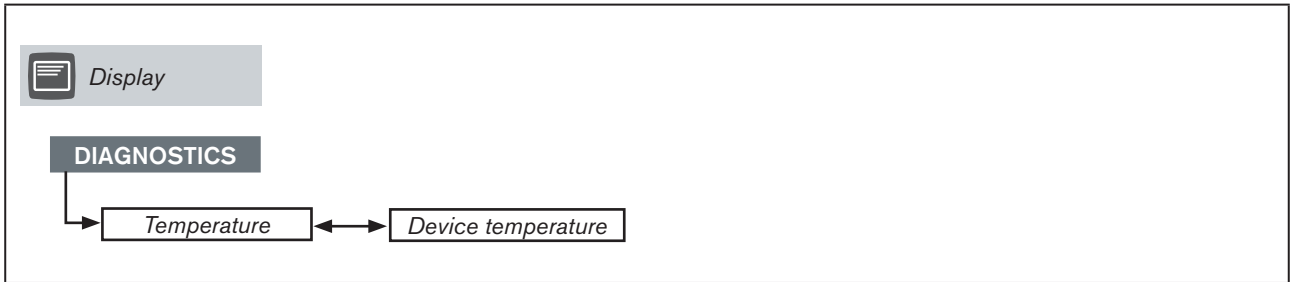

Image 67: Operating structure – 4-b, diagnostics display

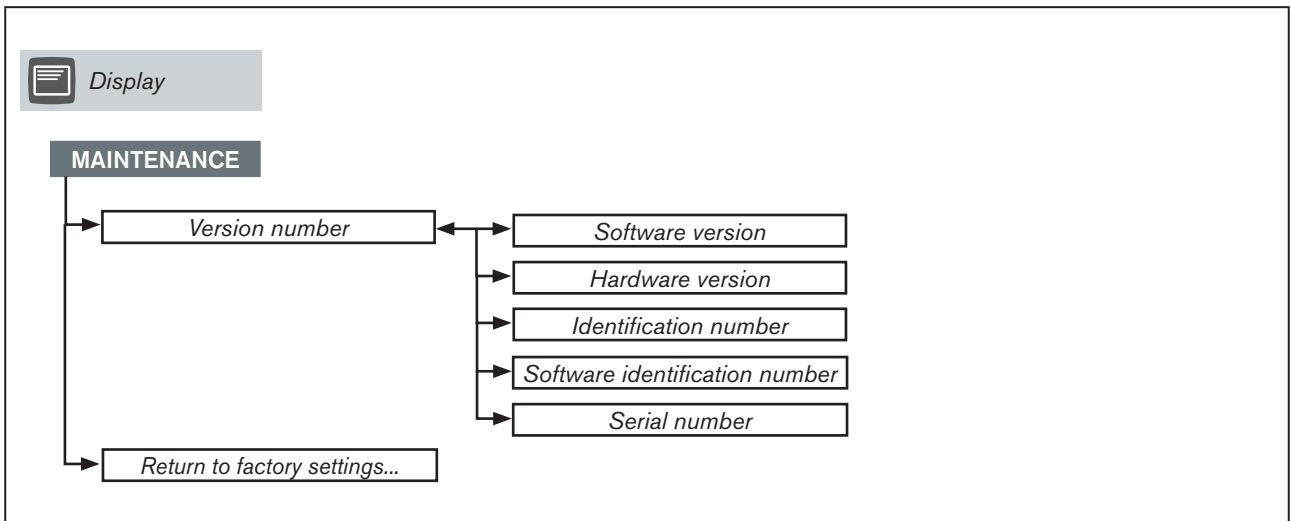

Image 68: Operating structure – 4-c, maintenance display

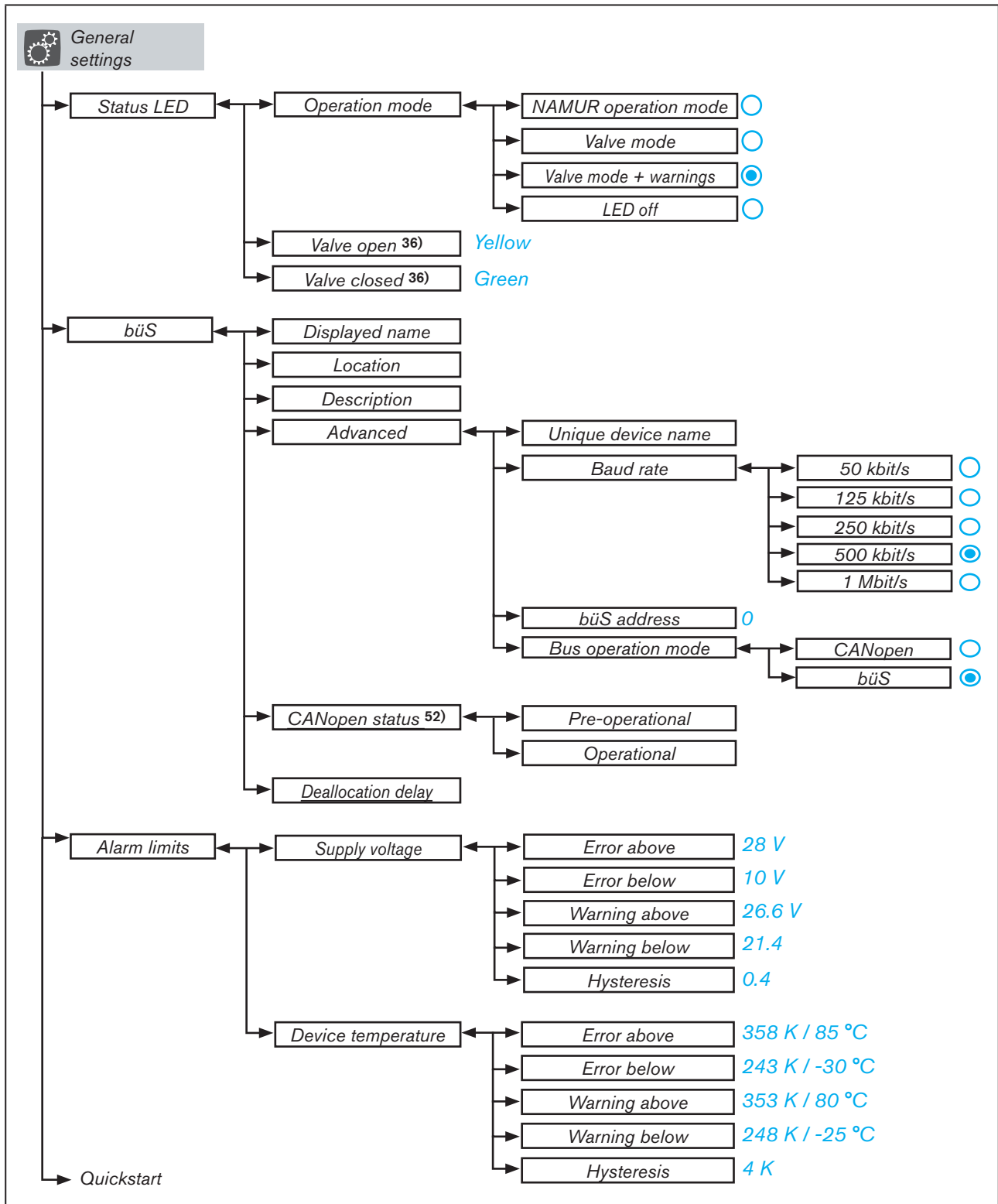

Image 69: Operating structure – 5-a, configuration area “General settings”

<sup>36)</sup> Only available if selected in the menu **Operation mode** → **Valve mode** or **Valve mode+warnings**.

<sup>52)</sup> Only available if selected in the menu **Bus operation mode** → **CANopen**.

MAN 1000274112 EN Version: G Status: RL (released | freigegeben) printed: 28.05.2021

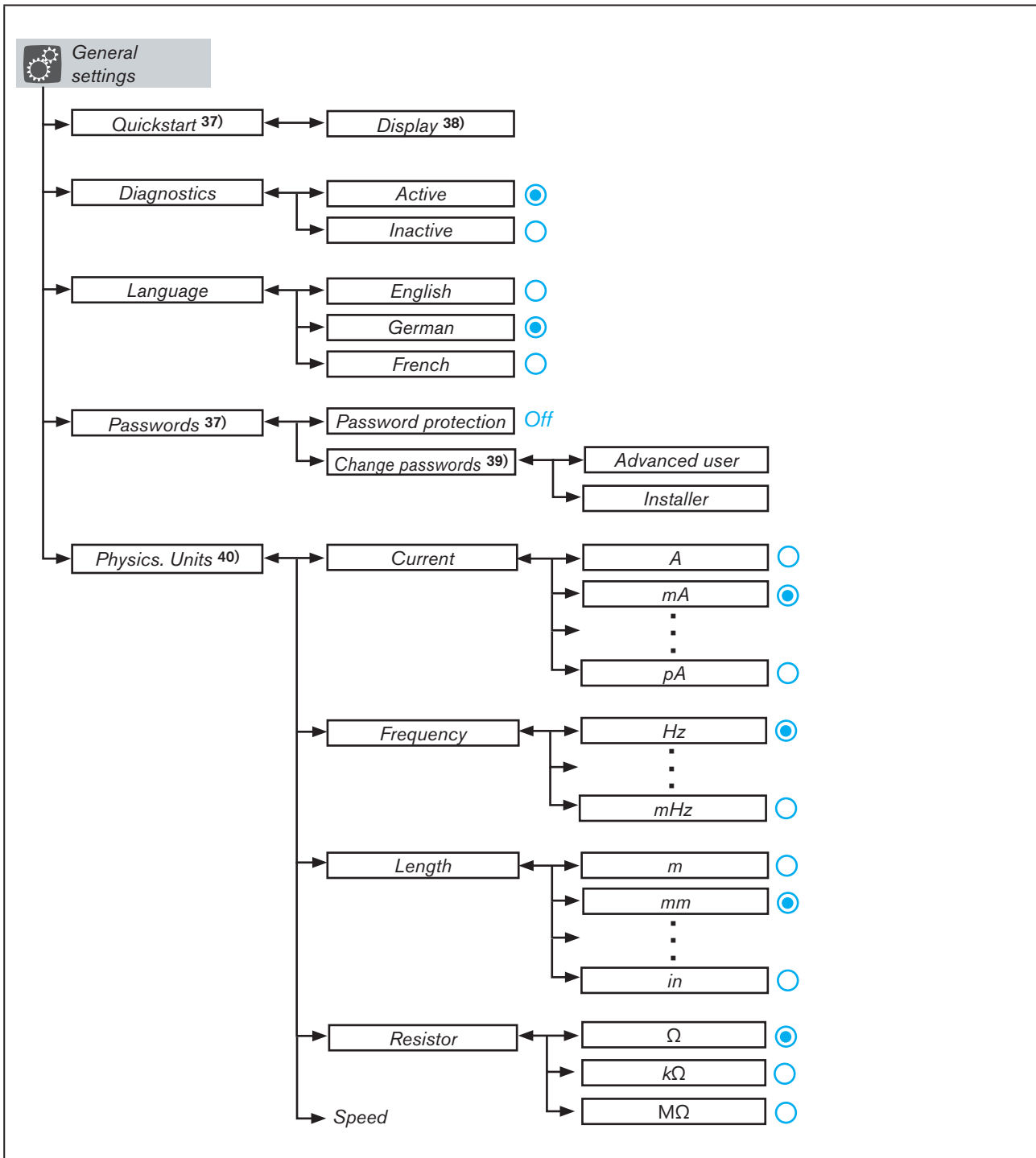

Image 70: Operating structure – 5-b, configuration area “General settings”

37) Only available on display.

38) The menu name depends on the selected language.

39) Only available if selected in the menu **Password protection** → **On**.

40) Only available on display.

The setting in the Communicator software is made in the menu bar **View** → **Unit system**.



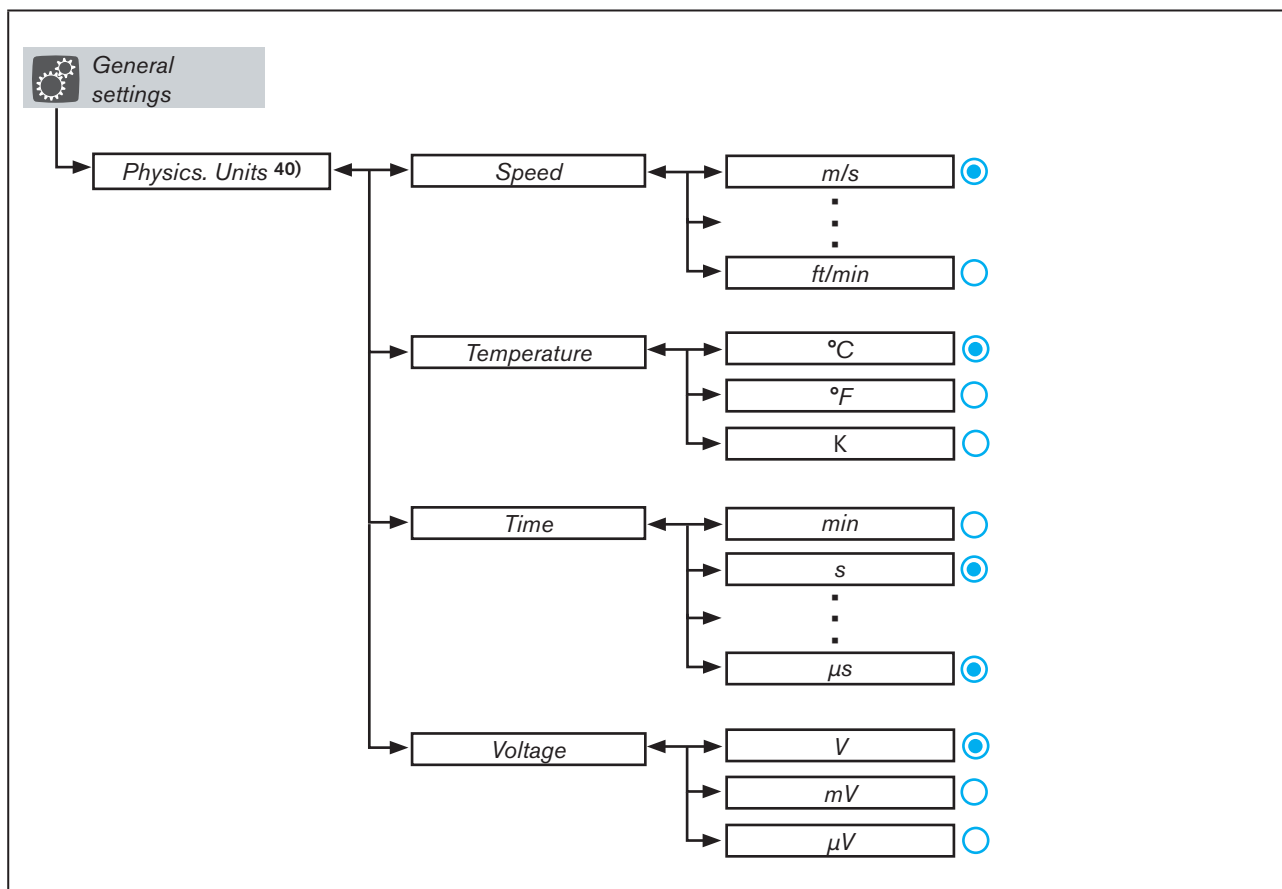

Image 71: Operating structure – 5-c, configuration area “General settings”

MAN 1000274112 EN Version: G Status: RL (released | freigegeben) printed: 28.05.2021

<sup>40)</sup> Only available on display.

The setting in the Communicator software is made in the menu bar **View** → **Unit system**.

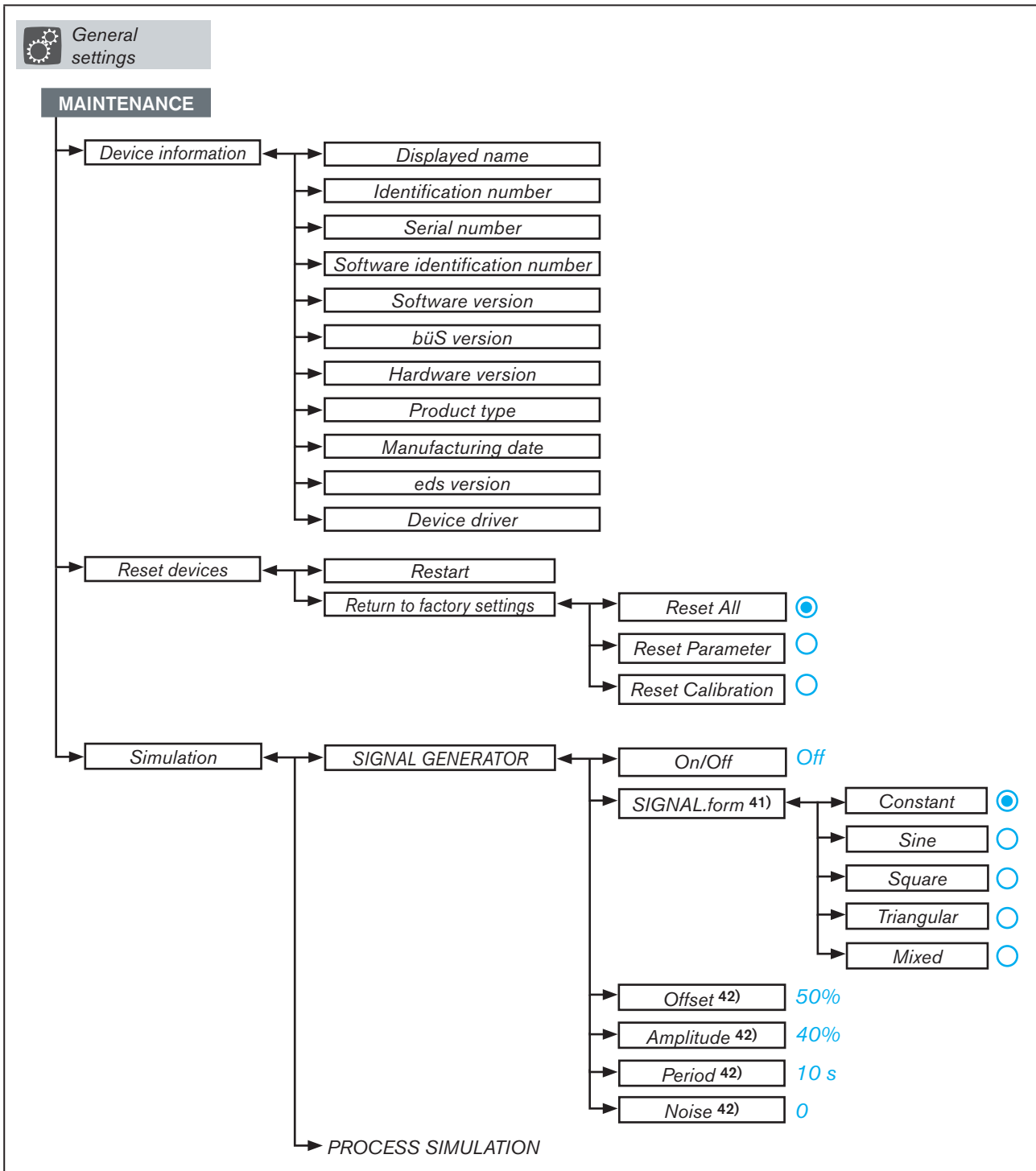

Image 72: Operating structure – 5-d, general settings maintenance

41) Only available if selected in the menu **SIGNAL GENERATOR** → **on | off** → **On**.

42) The display depends on the selection in the menu **SIGNAL.form**.

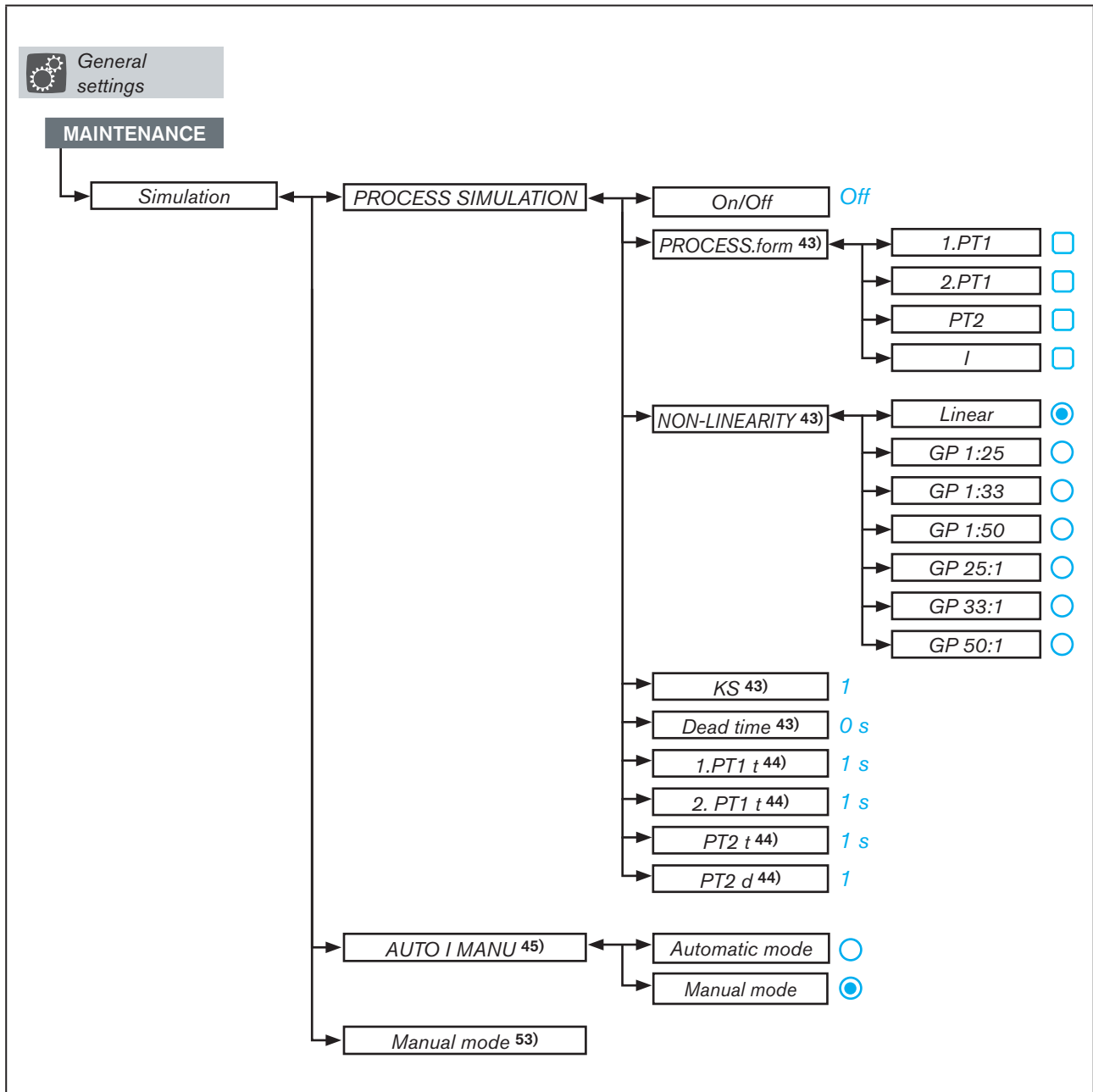

Image 73: Operating structure – 5-d, general settings maintenance

43) Only available if selected in the menu **PROCESS SIMULATION** → **on | off** → **On**.

44) Display depends on selection in menu **PROCESS.form**.

45) Only available in devices with display module.

53) Only available in devices with display module and if selected in menu **AUTO I MANU** → **Manual mode**.

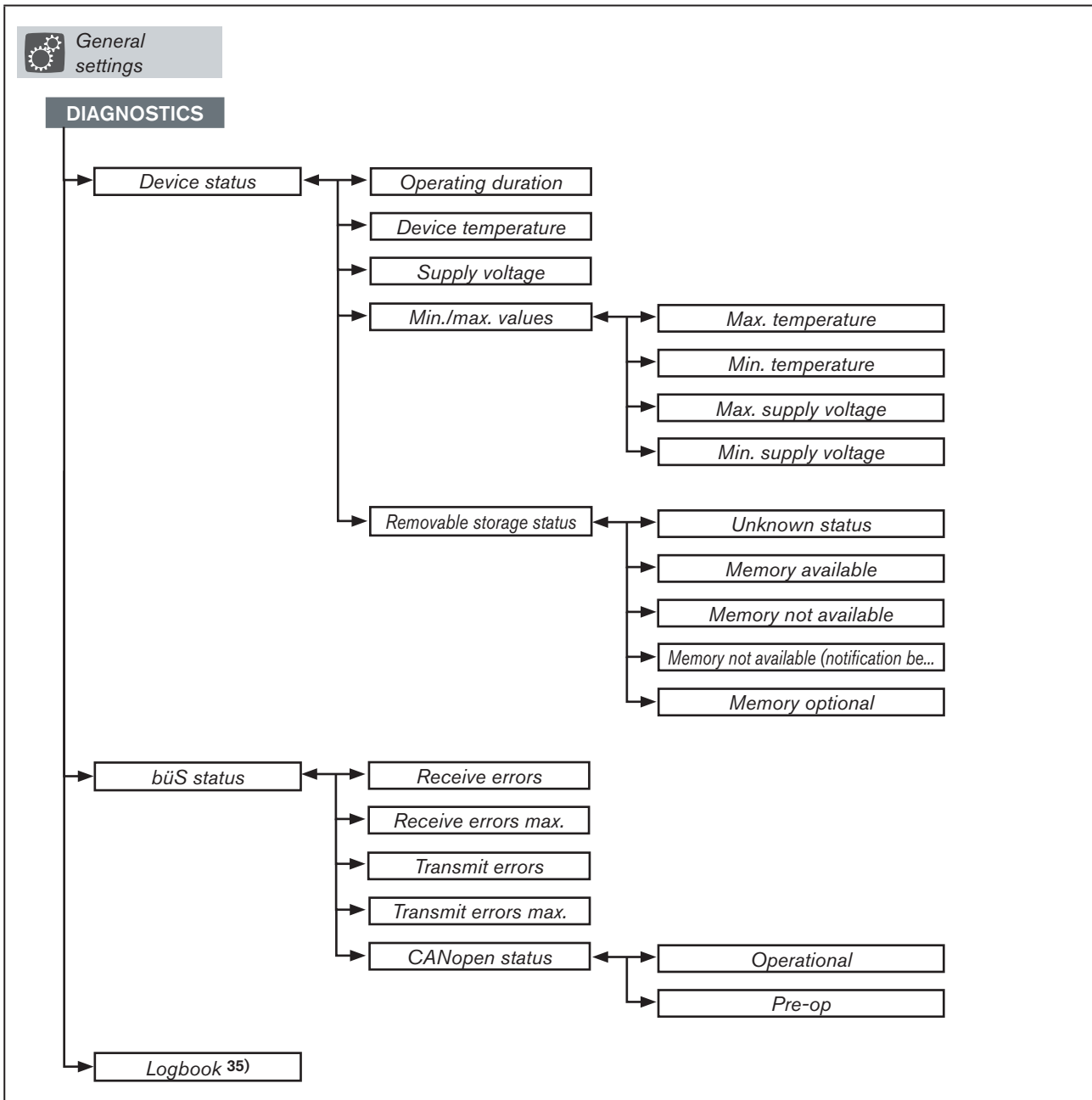

Image 74: Operating structure – 5-f, general settings diagnostics

MAN 1000274112 EN Version: G Status: RL (released | freigegeben) printed: 28.05.2021

## 17.2 Context menu for operation on display

The context menu is only available on the display in the operating structure shown.

In the Bürkert Communicator software, the partially identical menus are integrated differently into the operating structure.



A detailed description of the Bürkert Communicator software can be found in the respective operating instructions. **Download at:** [www.burkert.com / Communicator](http://www.burkert.com / Communicator)

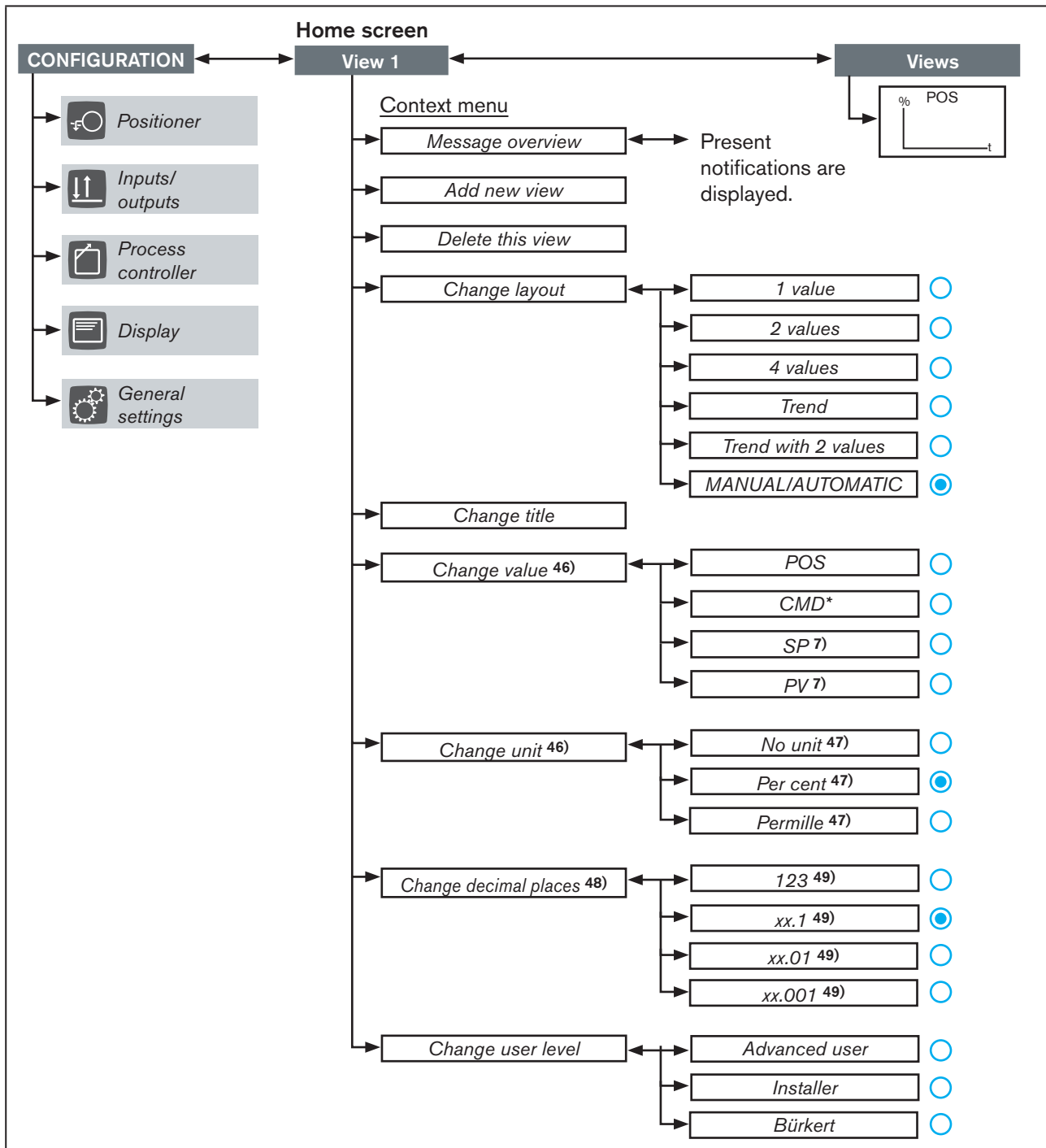

Image 75: Operating structure – 6, context menu for views

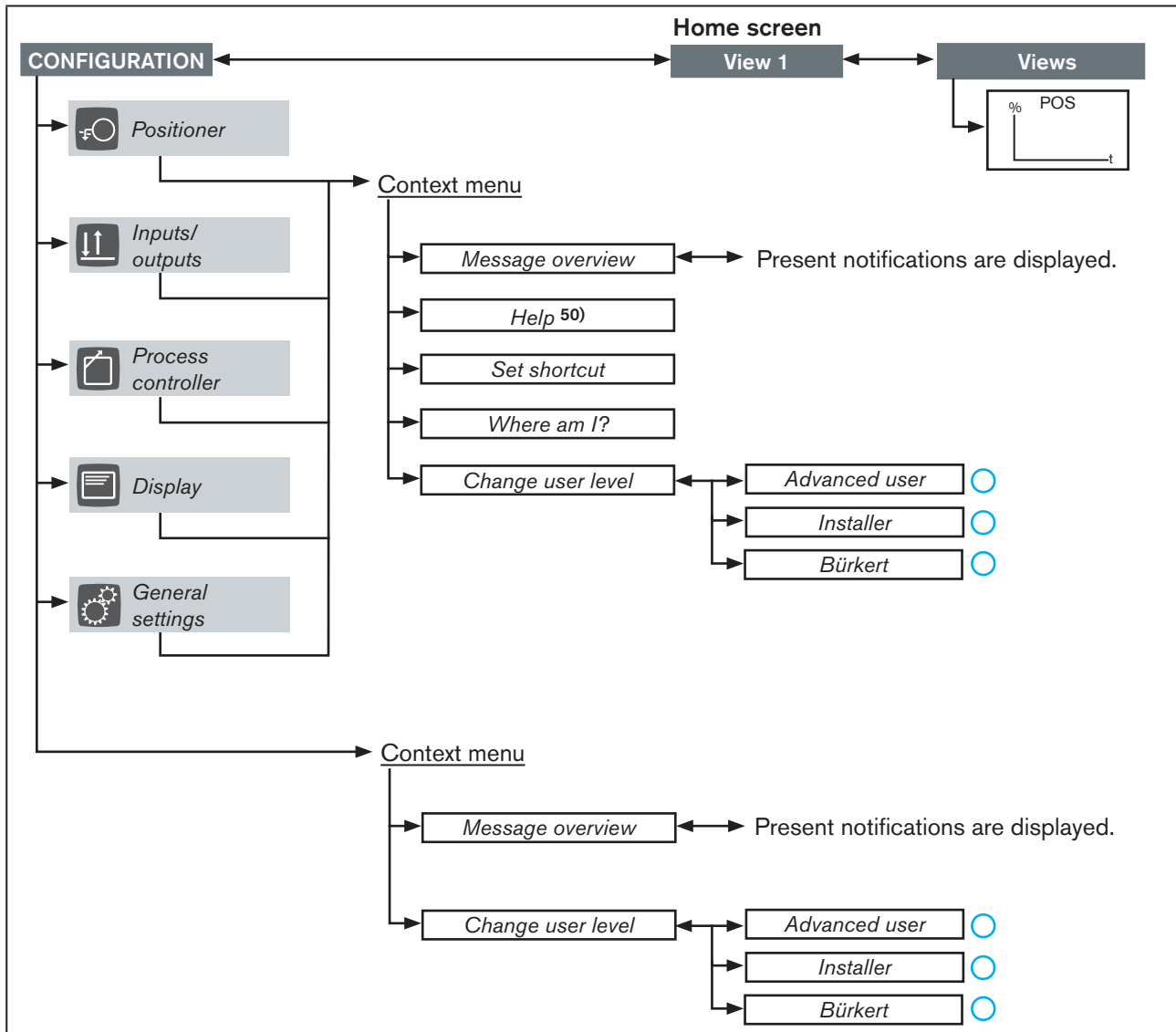

Image 76: Operating structure – 7, context menu in configuration area

7) Only available in devices with process control function

46) Not available for layout **MANUAL/AUTO**. With set layout **2 values** or **4 values**, a submenu for assigning the value to be changed is displayed.

47) During process control, the selection depends on the physical unit of the process control (**Process controller** → **UNIT**) and the value selected to be shown on the display (Context menu → **Change value**).

48) Not available for layout **Trend**, **Trend with 2 values** or **MANUAL/AUTO**. With set layout **2 values** or **4 values**, a submenu for assigning the value to be changed is displayed.

49) Not constantly available.

50) Only available in configuration area **Position controller**, **Inputs/outputs** and **Process controller**.

## 18 INDUSTRIAL ETHERNET

To allow connection to an Ethernet network, the electromotive control valve with integrated fieldbus gateway is optionally available.

**Supported fieldbus protocols:** Ethernet/IP, PROFINET, Modbus TCP.

### 18.1 Fieldbus gateway description

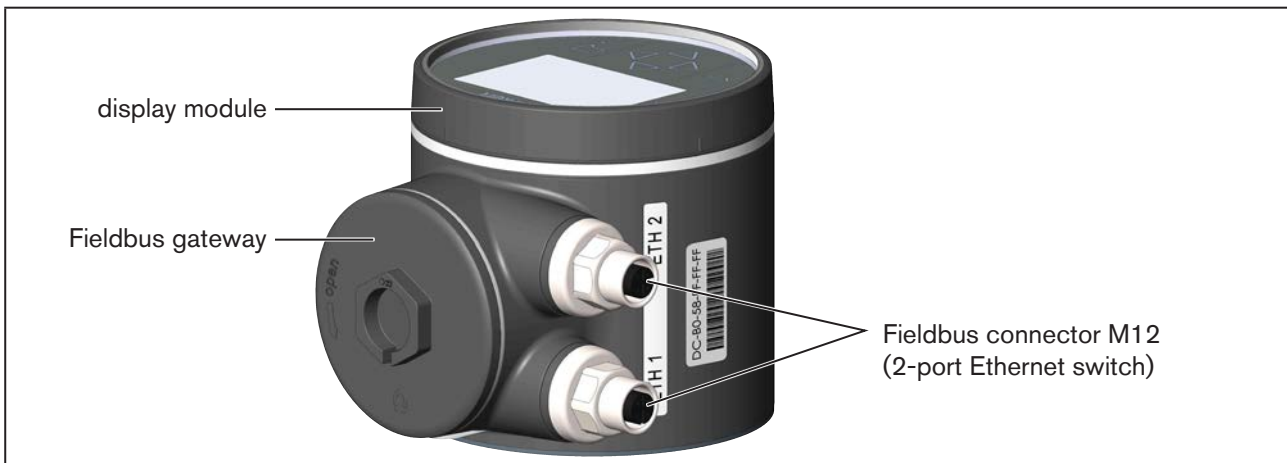

Image 77: Fieldbus gateway with display module

#### 18.1.1 Access to bÜS service interface

The bÜS service interface is located inside the Fieldbus gateway.

To access it, turn the cover counterclockwise.

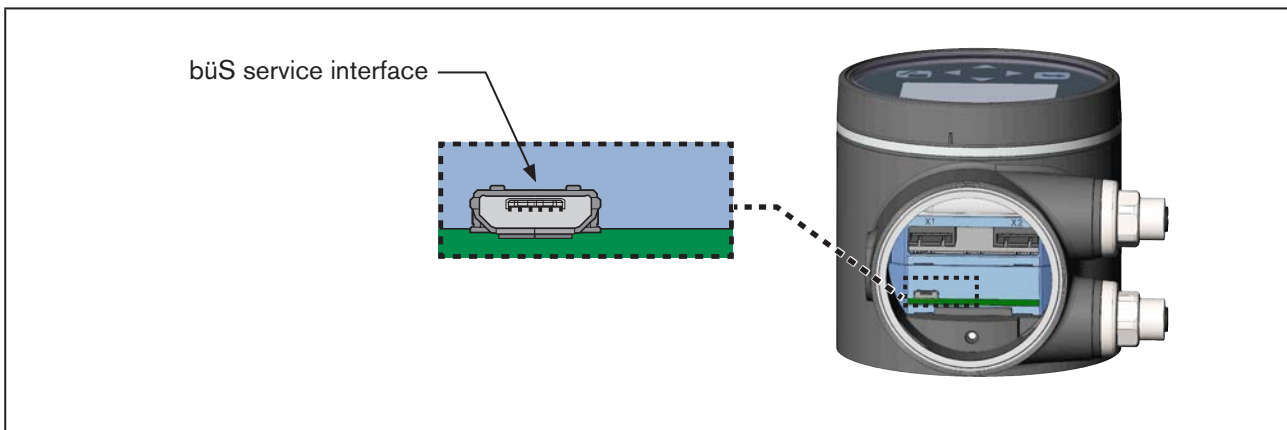

Image 78: bÜS service interface with Fieldbus gateway variant



**For electrical connection of Fieldbus gateway:**  
see chapter [“10.2 Electrical connection Fieldbus gateway”](#) on page 57.

### 18.1.2 LEDs for indicating network connection status

The LEDs for indicating network connection status are located inside the fieldbus gateway.

To access it, turn the cover counterclockwise.

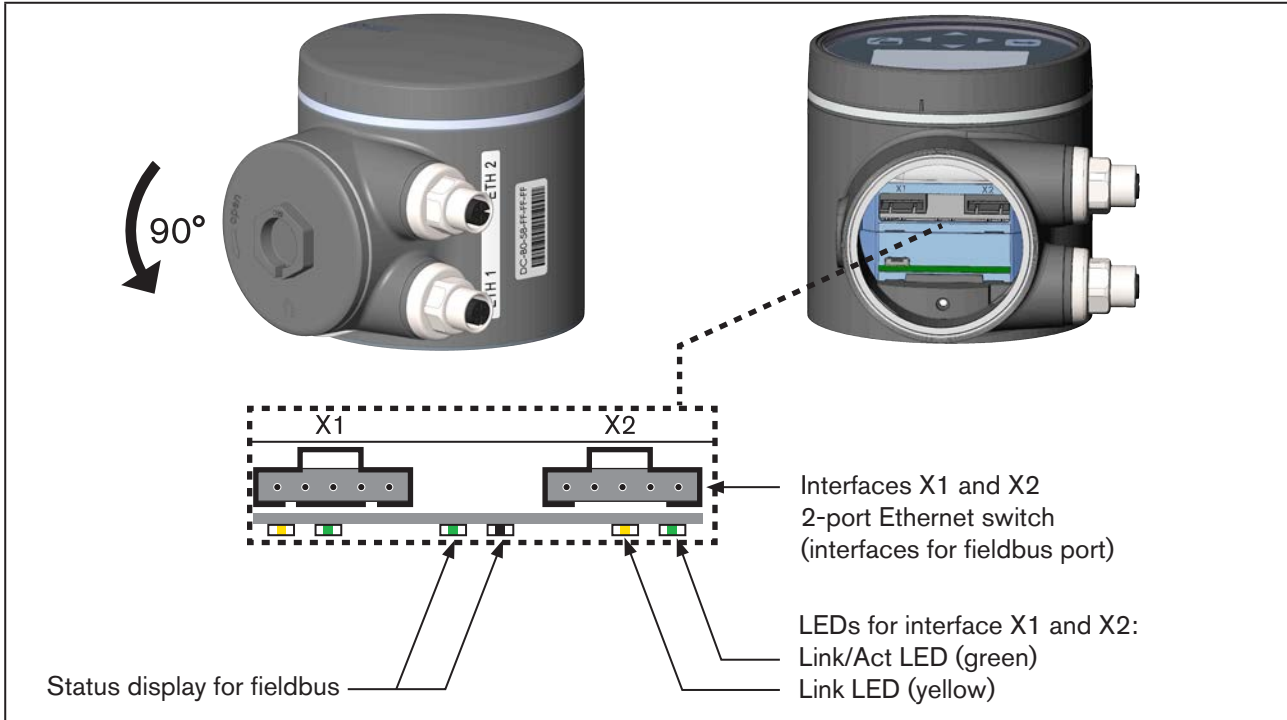

Image 79: LEDs for indicating network connection status

LED status		Fault description/cause	Measure
Link/Act LED (green)	Active	Rapid flashing: Connection with overriding protocol layer EtherNet/IP has been established. Data are being transmitted.  Slow flashing: There is no connection to the protocol layer. This is normally the case for approx. 20 seconds after restarting.	
	Not active	No connection to the network available.	Check cable.
Link LED (yellow)	Active	Connection to network active.	-
	Not active	No connection to the network available.	Check cable.

Table 41: LED status indicators of interfaces X1 and X2 for EtherNet/IP (fieldbus port)



## 18.2 Technical data Industrial Ethernet

### 18.2.1 PROFINET IO specifications

Topology recognition	LLDP, SNMP V1, MIB2, Physical Device
Minimum cycle time	10 ms
IRT	not supported
MRP media redundancy	MRP client is supported
Other supported functions	DCP, VLAN Priority Tagging, Shared Device
Transmission speed	100 MBit/s
Data transport layer	Ethernet II, IEEE 802.3
PROFINET IO specification	V2.3
(AR) Application Relations	The device can simultaneously process up to 2 IO-ARs, 1 Supervisor AR and 1 Supervisor-DA AR.
DNS compatible name	„“ (no entry)
Static IP address	0.0.0.0
Network mask	0.0.0.0
Default gateway	0.0.0.0

With these factory default settings the address allocation can be done via DCP and LLDP according to PROFINET-specifications.

### 18.2.2 EtherNet/IP specifications

Pre-defined standard objects	Identity Object (0x01) Message Router Object (0x02) Assembly Object (0x04) Connection Manager (0x06) DLR Object (0x47) QoS Object (0x48) TCP/IP Interface Object (0xF5) Ethernet Link Object (0xF6)
DHCP	supported
BOOTP	supported
Transmission speed	10 and 100 MBit/s
Duplex modes	Half duplex, full duplex, auto-negotiation
MDI modes	MDI, MDI-X, Auto-MDIX
Data transport layer	Ethernet II, IEEE 802.3
Address Conflict Detection (ACD)	supported
DLR (ring topology)	supported
Integrated switch	supported
CIP reset service	Identity Object Reset Service types 0 and 1

Static IP address	192.168.0.100
Network mask	255.255.255.0
Default gateway	192.168.0.1

### 18.2.3 Modbus TCP specifications

Modbus function codes	1, 2, 3, 4, 6, 15, 16, 23
Operation mode	Message mode: Server
Transmission speed	10 and 100 MBit/s
Data transport layer	Ethernet II, IEEE 802.3
Static IP address	192.168.0.100
Network mask	255.255.255.0
Default gateway	192.168.0.1

## 18.3 Projecting via fieldbus

For project planning, you need the suitable start-up file for the respective fieldbus protocol.

Fieldbus	Start-up file
EtherNet/IP	EDS file
PROFINET	GSDML file
Modbus TCP	not required

The start-up files required for the respective project planning software and their description are available on the Internet.



**Download at:**

[www.burkert.com / Type 3360, 3361 / Downloads "Software" / Initiation Files](http://www.burkert.com / Type 3360, 3361 / Downloads 'Software' / Initiation Files)

Please refer to the documentation of your project design software for instructions regarding the installation of the start-up files.

### 18.3.1 Setting the Ethernet parameters for EtherNet/IP, PROFINET, Modbus TCP



With Modbus TCP, it is essential to set the Ethernet parameters.



**Setting option:**

Using the Bürkert Communicator software, using the web server or on the display of the device (option).

Settings are created on the PC using the büS service interface and the Bürkert Communicator software. It requires the USB büS interface set available as an accessory.

Display operation: Button functions

	Select, activate		Confirm		Back
--	------------------	--	---------	--	------

To set the Ethernet parameters, you must switch to the detailed view "Parameters for Industrial Communication".

**How to switch to detailed view:**

→ For setting with Bürkert Communicator, select **Industrial Communication** in the navigation area.

→ When using the display for the configuration, switch to **CONFIGURATION** on the home screen and select **Industrial Communication**.

✓ You are now in the “Parameter” detailed view.



The Ethernet parameters can only be set when the corresponding fieldbus protocol has been selected.  
**Parameter** → **Protocol settings** → **Protocol** → Select protocol.

**Setting the Ethernet parameters:**

→ **Select Protocol settings**.

→ Select **Protocol** and set the desired fieldbus protocol.

**Settings:**

→ **Select IP settings** and create settings.

- **DNS compatible name** can only be set with PROFINET. Factory default setting: no entry
- **Static IP address** Factory default setting: 192.168.0.100
- **Network mask** Factory default setting: 255.255.255.0
- **Default gateway** Factory default setting: 192.168.0.1.



With PROFINET, the factory default setting is 0.0.0.0.

✓ You have set the Ethernet parameters to connect the device to the PLC network.

## 18.4 Web server

The configuration of the Ethernet participant, required to connect to the network, can be run with a web server.

### 18.4.1 Connecting to the web server

→ Only with PROFINET: Assign IP addresses and DNS-compatible name with a suitable start-up tool for PROFINET attachments.

→ Set IP address in the PC network card.

IP address: **192.168.0.xxx**

For xxx, enter any numerical value other than 100  
(100 is occupied by the IP address of the Ethernet participant by default).

→ Connect the PC with a network cable to the Ethernet participant.

### 18.4.2 Access to the web server

The screenshot shows a web browser interface for the Bürkert web server. At the top left is a 'Menu' button with a hamburger icon. At the top right is the Bürkert logo. Below the header, the text 'Bürkert' is on the left and 'S/N: 99' is on the right. The main heading is 'Industrial Communication'. Below this is a table with the following data:

Protocol	Ethernet/IP
Communication status	Wait for establishing communication
MAC address	00:50:C2:C7:E0:01
Static IP address	192.168.0.100
Network mask	255.255.255.0
Default gateway	192.168.0.1
Temporary IP address	192.168.0.100
IP settings	None

Image 80: Access to the web server via the default IP

With EtherNet/IP, DHCP or BOOTP can also be set (NOT by default).  
In this process, the IP address is acquired from a DHCP server.

→ Open an internet browser.

→ Enter default IP **192.168.0.100**.

(On EtherNet/IP devices, the IP address is assigned by a DHCP server. If no address is assigned via DHCP within 1 minute, the device uses the default IP 192.168.0.100.)

The software for configuring the Ethernet participant is now available on the PC.



**Configuration of multiple devices:**

On delivery, all devices have the same IP address (192.168.0.100 or 0.0.0.0 for PROFINET). So that the device can be identified for configuration, only 1 unconfigured device may be on the network.

- ▶ Successively connect the devices (Ethernet participants) to the network individually and configure them.

### 18.4.3 Configuring Ethernet participants

Logging onto the system:

→ Enter your user name and password . Username: **admin**  
Password: **admin**

The screenshot shows a web browser window with a dark grey header. On the left is a 'Menu' icon and text. On the right is the 'bürkert' logo. Below the header is a blue bar with 'Bürkert' on the left and 'S/N: 99' on the right. The main content area has a large 'User login' heading. Below it is a form with two rows: 'User name' with the value 'admin' and 'User password' with the value 'admin' and a small 'x' icon in the top right corner of the password field. At the bottom left of the form is a dark grey button with the text 'Login'.

Image 81: Logging onto the system

Configuration:

- Enter the device name and IP address for the Ethernet participant.  
The device name assigned here is used later during project planning (e.g. under STEP 7).
- Confirm with **Commit changes**.
- Conduct a power reset of the Ethernet participant to incorporate the changed parameters.
- Restart the device with **Restart device**.

The screenshot shows the Bürkert web interface for network configuration. At the top, there is a 'Menu' button and the Bürkert logo. Below the logo, the device name 'Bürkert' and serial number 'S/N: 99' are displayed. The main heading is 'Network configuration'. Below this is a table with the following settings:

Protocol	EtherNet/IP
Static IP address	192.168.0.100
Network mask	255.255.255.0
Default gateway	192.168.0.1
IP settings	None

At the bottom of the configuration area, there are two buttons: 'Commit changes' and 'Restart device'.

Image 82: Configuring Ethernet participants

## 18.5 Advanced functionalities

### 18.5.1 Object route function

The object route function grants access to all objects in the system. Access requires the object, with index and sub-index, and the address of the device/module to be specified. Then the value can be read back.

The interface for this is described in the additional instructions.



Download at:  
[www.burkert.com / Type ME23 / Fieldbus description](http://www.burkert.com / Type ME23 / Fieldbus description)

The following objects allow additional control and monitoring.

### 18.5.2 Device Status NAMUR NE 107

Name		Description				Access type	
Device status NAMUR NE 107		Corresponds to device status of Type 3323, 3324, 3325				RO	
Bit 7	Bit 6	Bit 5	Bit 4	Bit 3	Bit 2	Bit 1	Bit 0
reserved	reserved	NAMUR operation mode: 0 – AUTOMATIC operating state 1 – MANUAL operating state 2 – flashing		NAMUR status: 0 – normal 1 – diagnostics active 2 – maintenance required 3 – outside of specification 4 – warning 5 – error			

Table 42: Device Status NAMUR NE 107

### 18.5.3 bÜS Control Object

Name	Description	Access type
Control mode*	Byte 0: defines device behaviour and communication with the connected devices. It can thus be determined when the device begins transmitting process data.  Byte 1: defines device behaviour when a participant fails.	RW
Control Word**	Byte 0: Address of the device to be controlled.  Byte 1: Note (device) management as per CANopen specification.	RW

*	<b>Byte 1</b>	<b>Byte 0</b>
	0: reserved	0: AUTOMATIC operating state (bÜS default)
	1: Do not remove assignment to missing participant	1: enter for operation with KOM 2: enter for operation with PLC
	<b>Byte 3</b>	<b>Byte 2</b>
	Reserved	Reserved
**	<b>Byte 1</b>	<b>Byte 0</b>
	0x81: Node reset (device restart)	0xFF: All participants
	<b>Byte 3</b>	<b>Byte 2</b>
	Reserved	Reserved

Table 43: bÜS Control Object

## 19 CANopen



For electrical installation of devices with CANopen network:  
refer to chapter [“10.1.5 X3 – M12 circular plug, 4-pin or 5-pin, operating voltage and büS/CANopen communication”](#) on page 56 for description.

### 19.1 Projecting via fieldbus

For project planning, you need an eds file as a start-up file for CANopen.

The eds file and the associated description are available on the Internet.



**Download at:**  
[www.burkert.com / Type 3360, 3361 / Downloads “Software” / Initiation Files](http://www.burkert.com/Type%203360,%203361/Downloads%20Software/Initiation%20Files)

Please refer to the documentation of your project design software for instructions regarding the installation of the start-up files.

### 19.2 CANopen network configuration

Instructions for the network configuration based on the CANopen protocol are available on the Internet.



**Download at:**  
[www.burkert.com / Type 3360, 3361 / Downloads “Operating instructions” / “Software instructions | CANopen network configuration”](http://www.burkert.com/Type%203360,%203361/Downloads%20Operating%20instructions/Software%20instructions%20CANopen%20network%20configuration)



## 20 bÜS

Definition: The term “bÜS” (Bürkert system bus) stands for the communication bus developed by Bürkert, based on the CANopen protocol.



**For electrical installation of devices with bÜS network:**

refer to chapter “[10.1.5 X3 – M12 circular plug, 4-pin or 5-pin, operating voltage and bÜS/CANopen communication](#)” on page 56 for description.

### 20.1 Cabling of bÜS networks



Additional information about cabling for bÜS networks is available at manual „Cabling Guide for bÜS/EDIP“ at [country.burkert.com](http://country.burkert.com)

### 20.2 Configuration of bÜS networks

Additional information about the configuration of bÜS networks can be found on the Internet.



**Download at:**

[www.burkert.com](http://www.burkert.com) / Type 8922 / Downloads / User Manuals / [Software instructions Typ8922, MExx | Software of f\(x\) configuration](#)

## 21 MAINTENANCE

The maintenance work is described in the separate service instructions. These instructions can be found on our homepage at: [country.burkert.com](http://country.burkert.com) → Type 3360, 3361.

### 21.1 Safety instructions



#### **DANGER!**

**Risk of injury due to high pressure in the system or device.**

- ▶ Switch off the pressure before working on the system or device. Vent or empty the lines.

**Risk of injury due to electric shock.**

- ▶ Switch off the power supply before working on the device or system. Secure against reactivation.
- ▶ Observe the applicable accident prevention and safety regulations for electrical devices!



#### **WARNING!**

**Risk of injury due to improper maintenance work.**

- ▶ Maintenance may be carried out only by trained specialist technicians and with the appropriate tools.
- ▶ Secure the system against unintentional activation.
- ▶ Following maintenance, ensure a controlled restart.

### 21.2 Actuator

When used in accordance with these operating instructions, the electromotive actuator is maintenance-free.

### 21.3 Wearing parts of the valve

Parts which are subject to natural wear are:

- Seals
- Control cone

→ If there is a leak, replace the respective wearing part with a corresponding spare part. (For spare part sets and assembly tools see chapter "[24.2 Spare parts](#)").

Replacement of the wearing parts is described in the separate service instructions.

These instructions can be found on our homepage at: [country.burkert.com](http://country.burkert.com) → Type 3360, 3361.

## 21.4 Visual inspection

According to the usage conditions, perform regular visual inspections:

- Check medium ports for tightness.
- Check relief bore on the pipe for leaks.

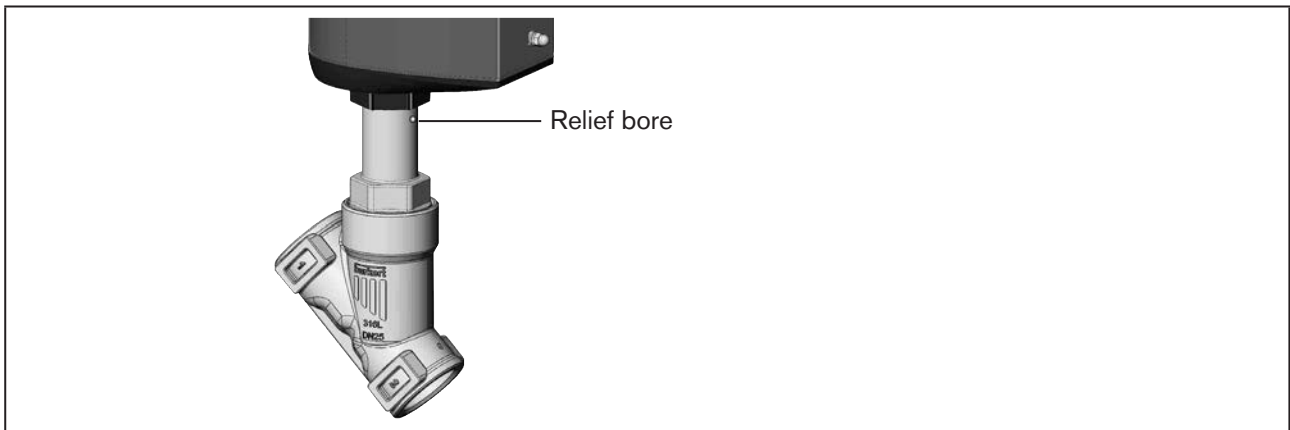

Image 83: Relief bore

## 21.5 Maintenance notifications

Maintenance notifications are displayed in the following LED operation modes:

- Valve mode + warnings (factory pre-set).  
The LED light ring alternately flashes blue and the colour indicating the valve position.
- NAMUR operation mode.  
The LED light ring glows blue.



If the LED operation mode is set to "valve mode", maintenance notifications are not displayed.

Notification	Device behaviour	Measure
The remaining service life of the energy pack is around 25%! The energy pack needs to be replaced soon.	Maintenance notification.	The SAFEPOS energy-pack must be promptly replaced before the end of its service life.

Table 44: Maintenance notifications

## 22 TROUBLESHOOTING AND MESSAGES

### 22.1 Error notifications

Device error notifications are displayed as follows:

- Valve mode  
The LED light ring alternately flashes red and the colour indicating the valve position.
- Valve mode + warnings (factory pre-set).  
The LED light ring alternately flashes red and the colour indicating the valve position.
- NAMUR operation mode.  
The LED light ring glows red.

Notification	Description	Device behaviour	Measure
Motor temperature is too high. Motor is moving to the safety position.	Too much friction in the actuator train for operation.	Error notification. Actuator is moving to the safety position.	Contact Bürkert service.
Motor temperature is too high. Motor is idling to prevent thermal damage.	Too much friction in the actuator train for operation.	Error notification. Motor switches off. Actuator remains in place. MANUAL operating state not possible.	Contact Bürkert service.
Excess temperature detected.	Device temperature too high for operation.	Error notification. Actuator is moving to the safety position. MANUAL operating state possible.	Reduce ambient temperature. Contact Bürkert Service if problem persists.
Low temperature detected.	Device temperature too low for operation.	Error notification. Actuator is moving to the safety position. MANUAL operating state possible.	Increase ambient temperature.
Overvoltage detected.	Supply voltage too high for device operation.	Error notification. Actuator is moving to the safety position. MANUAL operating state possible.	Check supply voltage.
Undervoltage detected.	Supply voltage failure, or supply voltage too low for device operation.	Error notification. Actuator is moving to the safety position. MANUAL operating state not possible.	Check supply voltage. Contact Bürkert Service if problem persists.
Motor current too high.	Increased friction in the actuator train or incorrect detection of the end positions.	Error notification. Motor switches off. Actuator remains in place. MANUAL operating state not possible.	Carry out the X.TUNE function. Contact Bürkert Service if problem persists.
Motor peak current too high.	Increased friction in the actuator train or incorrect detection of the end positions.		

Notification	Description	Device behaviour	Measure
Internal error: Reverberation sensor signal failure.	Signal failure of the position sensor.	Error notification. Actuator is moving to safety position. MANUAL operating state not possible.	Contact Bürkert service.
Internal error: ...	Internal error in the device.	Error notification. Actuator is moving to the safety position.	Contact Bürkert service.
CMD/SP cable break.	Cable break in the set-point signal.	If device is configured accordingly: Error notification. Actuator is moving to the safety position.	Check signal line of set-point value.
PV cable break.	Cable break of the process actual value signal.	If device is configured accordingly: Error notification. Actuator is moving to the safety position.	Check signal line of process actual value.
Persistent storage not usable: Defective or not available.	Reading or writing error of internal data storage EEPROM.	Error notification. Actuator is moving to the safety position	Restart the device. Contact Bürkert Service if problem persists.
BueS event: producer(s) not found.	Assigned external büS/CANopen producer cannot be found.	Error notification. Actuator is moving to the safety position.	Check signal to büS/CANopen partner.
BueS event: bus connection lost/not available.	büS/CANopen network cannot be found.	Error notification. Actuator is moving to the safety position.	Check büS/CANopen network.
BueS event: producer is not operational.	Producer not operational in this state.	Error notification. Actuator is moving to the safety position.	Check büS/CANopen producer.
BueS event: a device is using the same address.	Another büS/CANopen participant is using the same address.	Error notification. Actuator is moving to the safety position.	Assign a unique address to the device and büS/CANopen participant.
No correct connection to the process control system.	No connection to the process control system.	Error notification. Actuator is moving to the safety position.	Check connection to the process control system.
Energy storage must be replaced.	Storage capacity of the energy storage is too low. Assumption of the safety position cannot be guaranteed.	Error notification. Actuator is moving to the safety position.	Replace energy storage SAFEPOS energy-pack.
No energy storage available.	Energy storage SAFEPOS energy-pack not detected.	Error notification. Actuator is moving to the safety position.	Check whether the SAFEPOS energy-pack is correctly installed.

Table 45: Error notifications

## 22.2 Notifications on device status “Out of specification”

Notifications on device status “Out of specification” are displayed in the following LED operation modes:

- Valve mode + warnings (factory pre-set).  
The LED light ring alternatingly flashes yellow and the colour indicating the valve position.
- NAMUR operation mode.  
The LED light ring glows yellow.



In LED operation mode “valve mode”, notifications on the device status “Out of specification” are not displayed.

Notification	Description	Device behaviour	Measure
Motor temperature is high.	Increased friction in the actuator train.	Notification “Out of specification”	Contact Bürkert Service if problem persists.
Temperature warning limit exceeded.	Ambient temperature too high or increased friction in actuator train.	Notification “Out of specification”	Reduce ambient temperature. Contact Bürkert Service if problem persists.
Temperature warning limit undershot.	Ambient temperature is too low.	Notification “Out of specification”	Increase ambient temperature
Voltage warning limit exceeded.	Supply voltage is too high.	Notification “Out of specification”	Check supply voltage.
Voltage warning limit undershot.	Supply voltage is too low.		
CMD/SP cable break.	Cable break in the set-point signal.	If device is configured accordingly: Notification on status “Out of specification”. Actuator is moving to the safety position.	Check signal line of set-point value.
PV cable break	Cable break of the process actual value signal.	If device is configured accordingly: Notification on status “Out of specification”. Actuator is moving to the safety position.	Check signal line of process actual value.

Table 46: Notifications on device status “Out of specification”

## 22.3 Notifications on device status “Function check”

Notifications on device status “Function check” are displayed in the following LED operation modes:

- Valve mode + warnings (factory pre-set).  
The LED light ring alternately flashes orange and the colour indicating the valve position.
- NAMUR operation mode.  
The LED light ring glows orange.



In LED operation mode “valve mode”, notifications on the device status “Function check” are not displayed.

Notification	Description	Device behaviour	Measure
MANUAL operating state active.	Device is in the MANUAL operating state.	Notification “Function check”.	Switch to AUTOMATIC operating state.
Process simulation active	Device is in simulation mode: Process values are simulated.	Notification “Function check”.	Switch off process simulation.
Signal generator active	Device is in simulation mode: Input signals are simulated.	Notification “Function check”.	Switch off signal generator.
X.TUNE active	X.TUNE function is run (adaption of position control).	Notification “Function check”.	Wait until the X.TUNE function is exited.
P.TUNE active	P.TUNE function is run (adaption of process control).	Notification “Function check”.	Wait until the P.TUNE function is exited.
P.LIN active	P.LIN function is run (linearization of process characteristic).	Notification “Function check”.	Wait until the P.LIN function is exited.
External CMD not assigned.	“büs” is set as the source of the input signal.	Notification “Function check”.	Assign an external büS/ CANopen fieldbus consumer or set a different source.  Setting the input signal: Select “Inputs/outputs” in the configuration area.
External SP not assigned.	Missing assignment of the external büS/CANopen partner.		
External PV not assigned.			
External isPCOextern not assigned.			
External ExtError not assigned.			

Table 47: Notifications on device status “Function check”

## 23 CLEANING

### NOTE!

Do not use alkaline cleaning agents to clean the surfaces of the device.

## 24 ACCESSORIES, REPLACEMENT PARTS



### CAUTION!

**Risk of injury and/or damage due to incorrect parts.**

Incorrect accessories and unsuitable spare parts may cause injuries and damage the device and the area around it

- ▶ Use only original accessories and original spare parts from Bürkert.



Additional information about cabling for bÜS networks is available at manual „Cabling Guide for bÜS/EDIP“ at [country.burkert.com](http://country.burkert.com)

Accessories	Order number
Connection cable with M12 socket, 4-pin, (length 5 m) for operating voltage (without communication)	918038
Connection cable with M12 socket, 8-pin, (length 2 m) for input and output signals	919061
Connection cable with M12 plug, 5-pin, (length 2 m) for input signals process actual value (only for variant with process controller)	559177
USB bÜS interface set:	
USB bÜS interface set 1 (includes power supply unit, bÜS stick, terminating resistor, Y-distributor, 0.7 m cable with M12 plug)	772426
USB bÜS interface set 2 (includes bÜS stick, terminating resistor, Y-distributor, 0.7 m cable with M12 plug)	772551
bÜS adapter for bÜS service interface (M12 to micro-USB bÜS service interface)	773254
bÜS cable extensions from M12 plug to M12 socket	
Connection line, length 1 m	772404
Connection line, length 3 m	772405
Connection line, length 5 m	772406
Connection line, length 10 m	772407
Bürkert Communicator Type 8920	Info at <a href="http://country.burkert.com">country.burkert.com</a>
SIM card	291773
Holding device for port connection DN15–DN20	693770
Holding device for port connection DN25–DN50	693771

Table 48: Accessories



## 24.1 Communication software

The software Bürkert Communicator is designed for communication with Bürkert devices.



A detailed description of the installation and operation of the software can be found in the associated operating instructions.

Download the software from: [country.burkert.com](https://country.burkert.com)

### 24.1.1 bÜS service interface

The device is equipped with the bÜS service interface for communicating with the PC. Communication takes place via a USB interface on the PC and the USB bÜS interface, which is available as an accessory (see "[Table 48: Accessories](#)").

## 24.2 Spare parts

### 24.2.1 Spare parts for control valves of Types 3360 and 3361

Spare parts for Type 3360 and 3361		Order number	
SAFEPOS energy-pack		285834	
Plastic display module		277869	
Plastic blind cover		277881	
Seal set for packing gland	Spindle ø 10 mm, DN15–DN20	285685	
	Spindle ø 14 mm, DN25–DN50	285722	
Seal set for packing gland (high-temperature variant up to +230 °C)	Spindle ø 10 mm, DN15–DN20	384011	
	Spindle ø 14 mm, DN25–DN50	384012	
VA spindle guide for packing gland	Spindle ø 10 mm	Body DN15	246577
		Body DN20	246578
	Spindle ø 14 mm	Body DN25	246579
		Body DN32	246583
		Body DN40	246593
		Body DN50	246594

Table 49: Spare parts for Type 3360 and 3361

### 24.2.2 Spare parts for angle seat control valve Type 3360

Control cone set for Type 3360			
contains: control cone, spring-type straight pin, graphite seal			
Seat size valve	Order number		
	Stainless steel	PTFE	PEEK
15	170322	on request	210131
20	170323	170316	210135
25	170324	170318	210136
32	226925	226941	287822
40	225423	226945	314787
50	225426	226948	on request

Table 50: Control cone set for Type 3360

### 24.2.3 Spare parts for globe control valve Type 3361

Control cone set for Type 3361				
contains: control cone, spring-type straight pin, graphite seal				
Seat size valve	DN connection (valve body) [DN]	Order number		
		Stainless steel	PTFE	PEEK
3	10/15	347247	–	–
4	10/15	149934	–	–
6	10/15	152696	on request	on request
8	10/15	149935	on request	on request
10	10/15	149912	on request	on request
	20	149914	on request	on request
15	15	149915	on request	on request
	20	149916	on request	on request
	25	149917	on request	on request
20	20	149918	149946	231732
	25	149951	149947	292348
	32	226951	226963	301315
25	25	149953	149949	226723
	32	226952	226964	301317
	40	226954	226966	301319
32	32	226953	226965	301318
	40	226955	226967	301322
	50	226957	226969	301324
40	40	226956	226968	301323
	50	226958	226970	301369
50	50	226959	226971	272656

Table 51: Control cone set for Type 3361

<b>Valve seat set for Type 3361</b> contains: valve seat, graphite seal		
<b>Seat size valve</b>	<b>DN connection (valve body) [DN]</b>	<b>Order number</b>
3	10/15	284777
4	10/15	262143
6	10/15	262146
8	10/15	262147
10	10/15	262149
	20	262151
15	15	262152
	20	262153
	25	262155
20	20	262157
	25	262160
	32	262163
25	25	262170
	32	262171
	40	262173
32	32	262174
	40	262175
	50	262176
40	40	262177
	50	262178
50	50	262179

Table 52: Valve set for Type 3361

## 24.3 Assembly tools

### 24.3.1 Installation tools for control valves of Types 3360 and 3361

Modified socket wrench for packing gland			
Spindle ø [mm]	DN connection (valve body) [DN]	Width across flats	Order number
10	15	SW19	683220
10	20	SW21	683222
14	25–50	SW21	683223

Table 53: Installation tools for Types 3360 and 3361

### 24.3.2 Installation tools for control valves of Type 3361

Installation tool for replacing valve seat	
DN connection (valve body) [DN]	Order number
15	652604
20	652605
25	652606
32	652607
40	652608
50	652609
65	655562
80	655563
100	655564

Table 54: Installation tools for Type 3361

## 25 DISASSEMBLY

### 25.1 Safety instructions



#### **DANGER!**

**Risk of injury due to high pressure and escaping medium.**

If the device is pressurised while being disassembled, there is a risk of injury due to sudden depressurisation and medium discharge.

- ▶ Turn off the pressure before dismantling the device. Vent or empty the lines.



#### **CAUTION!**

**Risk of injury due to heavy device.**

During transportation or installation work, the device may fall down and cause injuries.

- ▶ Transport, install and remove heavy device with the aid of a second person only.
- ▶ Use suitable tools.

#### **NOTE!**

**Installing in the AUTOMATIC operating state will damage the device.**

Devices that are installed while they are in the AUTOMATIC operating state may be irreparably damaged.

- ▶ If devices are to be re-used, set the MANUAL operating state before they are removed.

- If the device is to be re-used, set the MANUAL operating state.
- Disconnect the electrical connection.
- Dismantle the device.

## 26 PACKAGING AND TRANSPORT

### NOTE!

#### Transport damage!

Inadequately protected devices may be damaged during transport.

- Protect the device against moisture and dirt in shock-resistant packaging during transportation.
- Avoid storage above or below the permitted storage temperature.



### CAUTION!

#### Risk of injury due to heavy device.

During transportation or installation work, the device may fall down and cause injuries.

- ▶ Transport, install and remove heavy device with the aid of a second person only.
- ▶ Use suitable tools.

## 27 STORAGE

### NOTE!

#### Incorrect storage may damage the device.

- Store the device in a dry and dust-free location.
- Storage temperature: -40 – +70 °C.

## 28 DISPOSAL

### NOTE!

#### Damage to the environment caused by parts contaminated with media.

- Dispose of the device and packaging in an environmentally-friendly manner.
- Observe applicable disposal and environmental regulations.



Observe national waste disposal regulations.

