

# SIEMENS

## SITRANS P

### Pressure transmitter SITRANS P320/P420 with 4 to 20 mA/HART

#### Operating Instructions

7MF03.0 (SITRANS P320 with 4 ... 20 mA/HART)  
7MF04.0 (SITRANS P420 with 4 ... 20 mA/HART)

Getting Started	1
Introduction	2
Safety information	3
Description	4
Installing/mounting	5
Connecting	6
Operating	7
Commissioning	8
Parameter assignment	9
Functional Safety	10
Service and maintenance	11
Diagnostics and troubleshooting	12
Technical data	13
Dimension drawings	14
Product documentation and support	A
Remote operation	B
Checklist for Functional Safety	C
Sealing plug / thread adapter	D
Abbreviations	E

## Legal information

### Warning notice system

This manual contains notices you have to observe in order to ensure your personal safety, as well as to prevent damage to property. The notices referring to your personal safety are highlighted in the manual by a safety alert symbol, notices referring only to property damage have no safety alert symbol. These notices shown below are graded according to the degree of danger.

 <b>DANGER</b>
indicates that death or severe personal injury <b>will</b> result if proper precautions are not taken.

 <b>WARNING</b>
indicates that death or severe personal injury <b>may</b> result if proper precautions are not taken.

 <b>CAUTION</b>
indicates that minor personal injury can result if proper precautions are not taken.

<b>NOTICE</b>
indicates that property damage can result if proper precautions are not taken.

If more than one degree of danger is present, the warning notice representing the highest degree of danger will be used. A notice warning of injury to persons with a safety alert symbol may also include a warning relating to property damage.

### Qualified Personnel

The product/system described in this documentation may be operated only by **personnel qualified** for the specific task in accordance with the relevant documentation, in particular its warning notices and safety instructions. Qualified personnel are those who, based on their training and experience, are capable of identifying risks and avoiding potential hazards when working with these products/systems.

### Proper use of Siemens products

Note the following:

 <b>WARNING</b>
Siemens products may only be used for the applications described in the catalog and in the relevant technical documentation. If products and components from other manufacturers are used, these must be recommended or approved by Siemens. Proper transport, storage, installation, assembly, commissioning, operation and maintenance are required to ensure that the products operate safely and without any problems. The permissible ambient conditions must be complied with. The information in the relevant documentation must be observed.

### Trademarks

All names identified by ® are registered trademarks of Siemens AG. The remaining trademarks in this publication may be trademarks whose use by third parties for their own purposes could violate the rights of the owner.

### Disclaimer of Liability

We have reviewed the contents of this publication to ensure consistency with the hardware and software described. Since variance cannot be precluded entirely, we cannot guarantee full consistency. However, the information in this publication is reviewed regularly and any necessary corrections are included in subsequent editions.

# Table of contents

<b>1</b>	<b>Getting Started .....</b>	<b>11</b>
1.1	Commissioning the device without display .....	11
1.2	Commissioning the device with display .....	12
<b>2</b>	<b>Introduction .....</b>	<b>15</b>
2.1	Purpose of this documentation .....	15
2.2	Scope of validity of this document .....	15
2.3	Document history .....	16
2.4	Product compatibility .....	16
2.5	Checking the consignment .....	17
2.6	Security information .....	17
2.7	Transportation and storage .....	18
2.8	Notes on warranty .....	18
<b>3</b>	<b>Safety information .....</b>	<b>19</b>
3.1	Precondition for use .....	19
3.1.1	Warning symbols on the device .....	19
3.1.2	Laws and directives .....	19
3.1.3	Conformity with European directives .....	20
3.1.4	Classification according to the pressure equipment directive .....	20
3.2	Requirements for special applications .....	21
3.3	Use in hazardous areas .....	21
<b>4</b>	<b>Description .....</b>	<b>25</b>
4.1	Area of application .....	25
4.2	Structure .....	27
4.3	Nameplate layout .....	28
4.4	Tag plate .....	30
4.5	Functional principle .....	30
4.5.1	Electronics .....	31
4.5.2	Measuring cell .....	32
4.5.2.1	Measuring cell for gauge pressure .....	33
4.5.2.2	Measuring cell for gauge pressure, front-flush membrane .....	34
4.5.2.3	Measuring cell for absolute pressure from the gauge pressure series .....	35
4.5.2.4	Measuring cell for absolute pressure, front-flush membrane .....	36
4.5.2.5	Measuring cell for absolute pressure from the differential pressure series .....	37
4.5.2.6	Measuring cell for differential pressure and flow rate .....	38
4.5.2.7	Measuring cell for level .....	39

4.6	System configuration .....	40
4.7	Remote seal and differential pressure flow measuring systems .....	41
4.7.1	Differential pressure - flow measuring systems.....	41
4.7.2	Remote seals and primary element for devices with functional safety.....	41
<b>5</b>	<b>Installing/mounting .....</b>	<b>43</b>
5.1	Basic safety instructions .....	43
5.1.1	Installation location requirements .....	46
5.1.1.1	Devices with marine approval.....	46
5.1.2	Proper mounting.....	47
5.2	Installation (except level) .....	47
5.3	Securing the device with mounting bracket .....	49
5.4	Mounting hygienic version .....	51
5.5	Installation (level) .....	51
5.5.1	Mounting on the container .....	53
5.6	Installation with remote seal .....	56
5.6.1	Remote seal measuring system .....	56
5.6.2	Remote seal with capillary line .....	57
5.7	Installing electrical connections and cable entries.....	63
5.8	Rotating the display .....	63
5.9	Rotating the enclosure .....	65
5.10	Removing .....	66
<b>6</b>	<b>Connecting .....</b>	<b>67</b>
6.1	Basic safety instructions .....	67
6.2	Connecting the device .....	70
6.2.1	Opening the device.....	70
6.2.2	Connecting the device .....	71
6.2.3	Closing the device.....	73
6.3	Connect the Han cable socket to the cable.....	73
6.4	Connect M12 cable socket to the cable.....	74
6.5	Switching on the supply voltage.....	76
<b>7</b>	<b>Operating.....</b>	<b>77</b>
7.1	Buttons.....	77
7.2	Operating the device with display.....	77
7.2.1	Navigating in the views .....	77
7.2.2	Measurement view .....	78
7.2.2.1	Display of measured values .....	79
7.2.2.2	Navigating in the measurement view .....	80
7.2.3	Parameter view .....	80
7.2.3.1	List of parameters on the display .....	80
7.2.3.2	Navigating in the parameter view.....	82
7.2.4	Edit view.....	82

7.2.4.1	Changing parameter values.....	83
7.2.5	Device status display.....	83
7.3	Remote operation.....	83
7.4	Locking the device.....	84
7.4.1	Write protection.....	84
7.4.2	Enable write protection with jumper.....	84
7.4.3	Enable user PIN.....	85
7.4.4	Enabling button lock.....	86
<b>8</b>	<b>Commissioning.....</b>	<b>89</b>
8.1	Basic safety instructions.....	89
8.2	Commissioning the device without display.....	90
8.3	Commissioning the device with display.....	91
8.4	Application examples.....	93
8.4.1	Gauge pressure, absolute pressure from differential pressure series, and absolute pressure from gauge pressure series.....	93
8.4.1.1	Commissioning in gaseous environments.....	93
8.4.1.2	Commissioning with steam or liquid.....	95
8.4.2	Differential pressure and flow rate.....	96
8.4.2.1	Commissioning in gaseous environments.....	96
8.4.2.2	Commissioning for liquids.....	97
8.4.2.3	Commissioning with vapor.....	99
<b>9</b>	<b>Parameter assignment.....</b>	<b>103</b>
9.1	Overview of parameters and functions.....	103
9.2	Parameter assignment over device with display.....	108
9.2.1	Pressure units [01].....	108
9.2.1.1	Display of the pressure units.....	109
9.2.1.2	Setting the pressure units.....	109
9.2.2	Set lower range value [02]/Set upper range value [03].....	110
9.2.2.1	Set lower range value parameter [02].....	110
9.2.2.2	Set upper range value parameter [03].....	110
9.2.2.3	Set lower range value/upper range value (without pressure available).....	111
9.2.3	Damping value [04].....	112
9.2.3.1	Set damping value.....	112
9.2.4	Application [05].....	112
9.2.4.1	Introduction.....	112
9.2.4.2	Set application.....	113
9.2.4.3	Pressure measurement.....	114
9.2.4.4	Level measurement.....	115
9.2.4.5	Volume and mass flow measurements.....	117
9.2.4.6	Volume measurement.....	120
9.2.5	Application point [06].....	121
9.2.6	Zero point adjustment [07].....	122
9.2.6.1	Adjusting zero point (gauge pressure).....	122
9.2.6.2	Adjusting the zero point (differential pressure).....	123
9.2.6.3	Adjusting zero point (absolute pressure).....	123
9.2.7	Apply lower range value [08]/Apply upper range value [09].....	124
9.2.7.1	Apply lower range value parameter [08].....	124

9.2.7.2	Apply upper range value parameter [09] .....	124
9.2.7.3	Apply lower range value/upper range value (with pressure present).....	124
9.2.8	Select fault current [10] .....	126
9.2.9	Lower fault current [11] .....	126
9.2.10	Upper fault current [12] .....	127
9.2.11	Lower saturation limit [13].....	127
9.2.12	Upper saturation limit [14].....	128
9.2.13	SV selection [15].....	129
9.2.14	Units [16] .....	129
9.2.14.1	Level units [16].....	130
9.2.14.2	Volume units [16] .....	130
9.2.14.3	Volume flow units [16] .....	130
9.2.14.4	Mass flow units [16] .....	131
9.2.15	Temperature units [17] .....	132
9.2.16	Lower scaling point [18] .....	132
9.2.16.1	Set lower scaling point.....	133
9.2.17	Upper scaling point [19] .....	133
9.2.17.1	Set upper scaling point .....	134
9.2.18	Low flow cut-off [20] .....	134
9.2.19	Vessel dimension A [21].....	135
9.2.20	Vessel dimension L [22] .....	135
9.2.21	Button lock [23].....	136
9.2.21.1	Enabling button lock.....	136
9.2.21.2	Disabling button lock .....	137
9.2.22	Change user PIN [24] .....	137
9.2.23	Recovery ID [25] .....	138
9.2.23.1	Display Recovery ID.....	138
9.2.24	PIN recovery [26] .....	139
9.2.24.1	Recovering the user PIN .....	139
9.2.25	User PIN [27] .....	140
9.2.25.1	Enable user PIN.....	140
9.2.25.2	Disable user PIN .....	141
9.2.26	Active device mode [28] .....	142
9.2.27	Functional Safety [29].....	142
9.2.28	Display test [30].....	142
9.2.29	Loop test [31] .....	143
9.2.29.1	Loop test with preset loop current value.....	143
9.2.29.2	Loop test with user defined loop current value.....	144
9.2.30	Start view [32].....	144
9.2.31	Pressure reference [33] .....	145
9.2.32	Identify the device [34] .....	145
9.2.33	Reset [35].....	146
9.2.33.1	Reset parameters .....	146
9.2.33.2	Reset to sensor calibration .....	146
9.2.33.3	Reset DAC trim to the factory setting .....	146
9.2.33.4	Restore ordered configuration .....	147
9.2.33.5	Restore factory settings.....	147
9.2.34	Overload behavior [36] .....	147
9.3	Parameter assignment over remote operation .....	148
9.3.1	Introduction.....	148
9.3.2	Quick start.....	148
9.3.3	Identification .....	149

9.3.4	Simulation .....	150
9.3.4.1	Simulate constant pressure values .....	150
9.3.4.2	Simulate ramp function.....	151
9.3.4.3	Simulate diagnostics .....	151
9.3.5	Customized characteristic curve .....	152
9.3.5.1	Introduction.....	152
9.3.5.2	"Custom units" parameter .....	152
9.3.5.3	Set customized characteristic curve .....	153
9.3.6	Sensor calibration .....	154
9.3.7	Digital-to-analog converter trim (DAC trim).....	155
9.3.8	Diagnostics functions.....	157
9.3.8.1	Limit monitoring and event counter .....	157
9.3.8.2	Trend log .....	160
9.3.8.3	Operating hours counter .....	161
<b>10</b>	<b>Functional Safety .....</b>	<b>163</b>
10.1	Safety concept .....	163
10.1.1	Random and systematic errors .....	163
10.1.2	SIL-compliant product version .....	163
10.1.3	Use in furnaces .....	164
10.1.4	Safety function .....	164
10.1.4.1	Device states.....	166
10.1.4.2	Safety characteristic values .....	167
10.1.5	Operating modes of the device .....	167
10.1.6	Device mode.....	168
10.1.6.1	Validation .....	169
10.1.6.2	Safety-related parameters .....	169
10.1.6.3	Device mode "Functional Safety enabled" .....	169
10.2	Enabling Functional Safety .....	170
10.2.1	Enabling Functional Safety over device with display.....	171
10.2.2	Enabling Functional Safety over remote operation .....	174
10.3	Acknowledging safety-related errors.....	178
10.3.1	"Safety critical error" device mode .....	178
10.3.2	Acknowledging safety-related errors via remote operation .....	179
10.4	Disabling Functional Safety over device with display .....	180
10.5	Disabling Functional Safety over remote operation .....	181
10.6	Proof test.....	182
10.6.1	Basic maintenance .....	182
10.6.2	Extended proof test.....	183
10.6.3	Simulating a safety-related error.....	184
10.6.4	Two-point measurement $\geq 20\%$ of the maximum measuring range.....	185
10.6.4.1	Example .....	187
10.6.5	Two-point measurement $\geq 50\%$ of the maximum measuring range.....	187
10.6.5.1	Example .....	189
10.6.6	Documenting a proof test .....	190
10.7	Repair and service .....	190
<b>11</b>	<b>Service and maintenance .....</b>	<b>191</b>
11.1	Basic safety instructions .....	191

11.2	Cleaning .....	192
11.2.1	Cleaning the enclosure .....	192
11.2.2	Servicing the remote seal measuring system .....	192
11.3	Maintenance and repair work.....	192
11.3.1	Checking the seals .....	194
11.3.2	Check cable glands .....	195
11.3.3	Replacing spare parts .....	195
11.3.3.1	Replacing electrical connections and cable entries .....	195
11.3.3.2	Replacing the display .....	195
11.3.3.3	Replacing the termination board .....	197
11.4	Return procedure .....	198
11.5	Disposal.....	198
<b>12</b>	<b>Diagnostics and troubleshooting.....</b>	<b>199</b>
12.1	Device status symbols .....	199
12.2	Diagnostic messages.....	202
12.3	Alarm and warning .....	207
12.4	Troubleshooting.....	208
12.5	Troubleshooting Functional Security.....	209
<b>13</b>	<b>Technical data .....</b>	<b>211</b>
13.1	Input .....	211
13.1.1	Gauge pressure.....	211
13.1.2	Gauge pressure with front-flush diaphragm.....	212
13.1.3	Gauge pressure from the differential pressure series .....	213
13.1.4	Absolute pressure from the gauge pressure series.....	214
13.1.5	Absolute pressure with front-flush diaphragm .....	215
13.1.6	Absolute pressure from the differential pressure series.....	216
13.1.7	Differential pressure and flow.....	217
13.1.8	Level.....	219
13.2	Measuring accuracy of SITRANS P320.....	220
13.2.1	Reference conditions.....	220
13.2.2	Effect of auxiliary power supply.....	220
13.2.3	Gauge pressure.....	220
13.2.4	Gauge pressure with front-flush diaphragm.....	221
13.2.5	Gauge pressure from the differential pressure series .....	222
13.2.6	Absolute pressure from the gauge pressure series.....	224
13.2.7	Absolute pressure with front-flush diaphragm .....	224
13.2.8	Absolute pressure from the differential pressure series.....	225
13.2.9	Differential pressure and flow.....	226
13.2.10	Level.....	229
13.3	Measuring accuracy of SITRANS P420.....	230
13.3.1	Reference conditions.....	230
13.3.2	Effect of auxiliary power supply.....	231
13.3.3	Gauge pressure.....	231
13.3.4	Gauge pressure with front-flush diaphragm.....	232
13.3.5	Gauge pressure from the differential pressure series .....	233



13.3.6	Absolute pressure from the gauge pressure series.....	234
13.3.7	Absolute pressure with front-flush diaphragm .....	235
13.3.8	Absolute pressure from the differential pressure series.....	236
13.3.9	Differential pressure and flow.....	237
13.3.10	Level.....	240
13.4	Output.....	241
13.5	Operating conditions .....	242
13.6	Vibration resistance .....	247
13.7	Construction.....	248
13.8	Torques .....	252
13.9	Display, keys and auxiliary power .....	253
13.10	Certificates and approvals.....	253
<b>14</b>	<b>Dimension drawings .....</b>	<b>259</b>
14.1	SITRANS P320/P420 for gauge pressure and absolute pressure from the gauge pressure series.....	259
14.2	SITRANS P320/P420 for differential pressure, gauge pressure, flow and absolute pressure from the differential pressure series.....	261
14.3	SITRANS P 320/P420 for level .....	263
14.4	SITRANS P320/P420 (front-flush).....	264
14.4.1	Note 3A and EHDG.....	265
14.4.2	Connections as per EN and ASME .....	265
14.4.3	F&B and pharma flange.....	266
14.4.4	PMC Style .....	268
14.4.5	Special connections .....	269
<b>A</b>	<b>Product documentation and support .....</b>	<b>271</b>
A.1	Product documentation .....	271
A.2	Technical support.....	272
<b>B</b>	<b>Remote operation .....</b>	<b>273</b>
B.1	SIMATIC PDM .....	273
B.1.1	Overview SIMATIC PDM.....	273
B.1.2	Check SIMATIC PDM version .....	273
B.1.3	Deactivate buffers when connecting via serial modem.....	274
B.1.4	Updating the Electronic Device Description (EDD).....	275
<b>C</b>	<b>Checklist for Functional Safety .....</b>	<b>277</b>
<b>D</b>	<b>Sealing plug / thread adapter .....</b>	<b>279</b>
D.1	Intended use of accessory part.....	279
D.2	Safety instructions for accessory part .....	279
D.3	Technical specifications of accessory part .....	280
D.4	Dimensional drawings for accessory part.....	281

<b>E</b>	<b>Abbreviations.....</b>	<b>283</b>
	<b>Glossary .....</b>	<b>285</b>
	<b>Index .....</b>	<b>289</b>

# Getting Started

## 1.1 Commissioning the device without display

### Introduction

In this section, you will learn how to commission the device step-by-step.

Before you start, please read the following safety notes:

- General safety notes (Page 19)
- Basic safety notes: Installing/mounting (Page 43)
- Basic safety notes: Connecting (Page 67)
- Basic safety notes: Commissioning (Page 89)

Read the entire device manual in order to achieve the optimum performance of the device.

### Procedure

1. Mount the device.  
Installation (except level) (Page 47)  
Installation (level) (Page 51)
2. Connect the device.  
Connecting the device (Page 70)
3. Switch on the supply voltage.  
Switching on the supply voltage (Page 76)

1.2 Commissioning the device with display

4. Open the cover of the buttons:

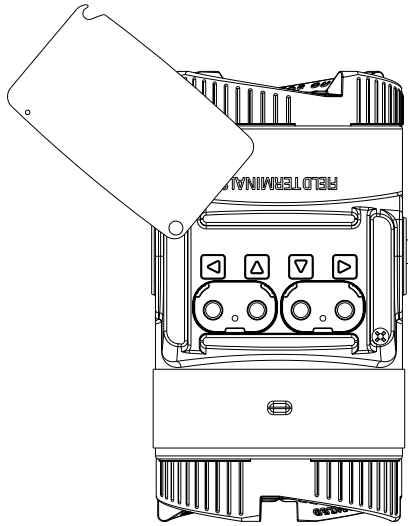

Figure 1-1 Top view

5. Operate the buttons as follows:

Apply lower range value (with pressure applied)	Hold down the button ▼ for 3 seconds.
Apply upper range value (with pressure applied)	Hold down the button ▲ for 3 seconds.
Zero point adjustment	Hold down the buttons ▲ and ▼ for 3 seconds.
Set Upper fault current	Hold down the button ◀ for 3 seconds.
Set Lower fault current	Hold down the button ▶ for 3 seconds.

Further functions are available via remote operation (e.g. SIMATIC PDM).

See also

Diagnostic messages (Page 202)

## 1.2 Commissioning the device with display

### Introduction

In this section, you will learn how to commission the device step-by-step.

Before you start, please read the following safety information:

- General safety information (Page 19)
- Basic safety information: Installing/mounting (Page 43)
- Basic safety information: Connecting (Page 67)
- Basic safety information: Commissioning (Page 89)

Read the entire device manual in order to achieve the optimum performance of the device.

## Procedure

1. Mount the device.  
Installation (except level) (Page 47)  
Installation (level) (Page 51)
2. Connect the device.  
Connecting the device (Page 70)
3. Switch on the supply voltage.  
Switching on the supply voltage (Page 76)
4. Open the cover of the buttons:

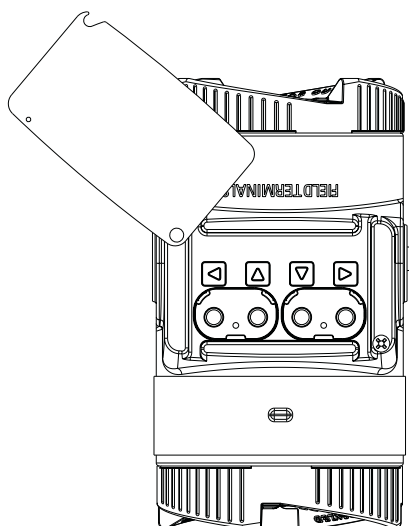

Figure 1-2 Top view

5. Set the measuring range.  
Set lower range value/upper range value (without pressure available) (Page 111)  
Apply lower range value/upper range value (with pressure present) (Page 124)
6. Set the pressure unit.  
Setting the pressure units (Page 109)
7. Set the application of your device.  
Set application (Page 113)
8. Set the scaling points.  
Set lower scaling point (Page 133)  
Set upper scaling point (Page 134)
9. Set the zero point.  
Adjusting zero point (gauge pressure) (Page 122)  
Adjusting the zero point (differential pressure) (Page 123)  
Adjusting zero point (absolute pressure) (Page 123)
10. Lock the device.  
Locking the device (Page 84)
11. Enable Functional Safety (for devices with Functional Safety).  
Enabling Functional Safety over device with display (Page 171)

You can find additional functions in the section Parameter assignment (Page 103)

**See also**

Diagnostic messages (Page 202)

## Introduction

### 2.1 Purpose of this documentation

These instructions contain all information required to commission and use the device. Read the instructions carefully prior to installation and commissioning. In order to use the device correctly, first review its principle of operation.

The instructions are aimed at persons mechanically installing the device, connecting it electronically, configuring the parameters and commissioning it, as well as service and maintenance engineers.

### 2.2 Scope of validity of this document

Variant	SITRANS P320	SITRANS P420
Gauge pressure	7MF030.	7MF040.
Gauge pressure from the differential pressure series	7MF031.	7MF041.
Absolute pressure from the gauge pressure series	7MF032.	7MF042.
Absolute pressure from the differential pressure series	7MF033.	7MF043.
Differential pressure and flow rate, MAWP 160 bar (2320 psi)	7MF034.	7MF044.
Differential pressure and flow rate, MAWP 420 bar (6092 psi)	7MF035.	7MF045.
Level	7MF036.	7MF046.

Article number of the variants

## 2.3 Document history

The overview below summarizes the most important changes in the documentation when compared to the previous edition.

Edition	Note
07/2021	<ul style="list-style-type: none"> <li>Section Technical data updated (e.g 160 bar measuring cell for differential pressure)</li> <li>Section Functional safety with proof test amended</li> </ul>
11/2019	<ul style="list-style-type: none"> <li>Changes for FW1.01.00 HART device revision 7</li> <li>Section Technical data updated</li> </ul>
09/2018	<ul style="list-style-type: none"> <li>Section Replacing spare parts (Page 195) added</li> <li>Basic safety notes in the sections Use in hazardous areas (Page 21), Installing/ mounting (Page 43), Connecting (Page 67) updated.</li> <li>Section Connecting the device (Page 70) updated</li> <li>Section Parameter assignment over remote operation (Page 148) updated</li> </ul>

### See also

Technical data (Page 211)

## 2.4 Product compatibility

The following table describes the compatibility between the edition of this manual, the device revision, the engineering system and the associated EDD.

Edition	Comments	Product compatibility	Compatibility with device integration package
07/2021	Manual revised	HART 7 FW: 1.01.00 or higher	SIMATIC PDM V9.0 or higher AMS Device Manager V13 or higher
11/2019	New device features	HW: 1.00.00 or higher	DTM Pactware V4.1 SP4 FC475 V3.9 or higher
09/2018	Manual revised	HART 7 FW: 1.00.08 or higher HW: 1.00.00 or higher	SIMATIC PDM V9.0 or higher AMS Device Manager V13 or higher DTM Pactware V4.1 SP4 FC475 V3.9 or higher
06/2018	First edition	HART 7 FW: 1.00.08 or higher HW: 1.00.00 or higher	SIMATIC PDM V9.0 or higher AMS Device Manager V13 or higher DTM Pactware V4.1 SP4 FC475 V3.9 or higher

See the following section to find out where to find your device-specific EDD:

Product documentation (Page 271)



## 2.5 Checking the consignment

1. Check the packaging and the delivered items for visible damages.
2. Report any claims for damages immediately to the shipping company.
3. Retain damaged parts for clarification.
4. Check the scope of delivery by comparing your order to the shipping documents for correctness and completeness.

 <b>WARNING</b>
<b>Using a damaged or incomplete device</b>
Risk of explosion in hazardous areas.
<ul style="list-style-type: none"><li>• Do not use damaged or incomplete devices.</li></ul>

## 2.6 Security information

Siemens provides products and solutions with industrial security functions that support the secure operation of plants, systems, machines and networks.

In order to protect plants, systems, machines and networks against cyber threats, it is necessary to implement – and continuously maintain – a holistic, state-of-the-art industrial security concept. Siemens' products and solutions constitute one element of such a concept.

Customers are responsible for preventing unauthorized access to their plants, systems, machines and networks. Such systems, machines and components should only be connected to an enterprise network or the internet if and to the extent such a connection is necessary and only when appropriate security measures (e.g. firewalls and/or network segmentation) are in place.

For additional information on industrial security measures that may be implemented, please visit

<https://www.siemens.com/industrialsecurity>.

Siemens' products and solutions undergo continuous development to make them more secure. Siemens strongly recommends that product updates are applied as soon as they are available and that the latest product versions are used. Use of product versions that are no longer supported, and failure to apply the latest updates may increase customer's exposure to cyber threats.

To stay informed about product updates, subscribe to the Siemens Industrial Security RSS Feed under

<https://www.siemens.com/industrialsecurity>.

Download any type of software files (available updates such as EDD) only from secure sources (e.g. SIOS Portal or SIEMENS page of product family).

## 2.7 Transportation and storage

To guarantee sufficient protection during transport and storage, observe the following:

- Keep the original packaging for subsequent transportation.
- Devices/replacement parts should be returned in their original packaging.
- If the original packaging is no longer available, ensure that all shipments are properly packaged to provide sufficient protection during transport. Siemens cannot assume liability for any costs associated with transportation damages.

<b>NOTICE</b>
<b>Insufficient protection during storage</b> The packaging only provides limited protection against moisture and infiltration. <ul style="list-style-type: none"><li>• Provide additional packaging as necessary.</li></ul>

Special conditions for storage and transportation of the device are listed in Technical data (Page 211).

## 2.8 Notes on warranty

The contents of this manual shall not become part of or modify any prior or existing agreement, commitment or legal relationship. The sales contract contains all obligations on the part of Siemens as well as the complete and solely applicable warranty conditions. Any statements regarding device versions described in the manual do not create new warranties or modify the existing warranty.

The content reflects the technical status at the time of publishing. Siemens reserves the right to make technical changes in the course of further development.

## Safety information

### 3.1 Precondition for use

This device left the factory in good working condition. In order to maintain this status and to ensure safe operation of the device, observe these instructions and all the specifications relevant to safety.

Observe the information and symbols on the device. Do not remove any information or symbols from the device. Always keep the information and symbols in a completely legible state.

#### 3.1.1 Warning symbols on the device

Symbol	Explanation
	Consult operating instructions

#### 3.1.2 Laws and directives

Observe the safety rules, provisions and laws applicable in your country during connection, assembly and operation. These include, for example:

- National Electrical Code (NEC - NFPA 70) (USA)
- Canadian Electrical Code (CEC) (Canada)

Further provisions for hazardous area applications are for example:

- IEC 60079-14 (international)
- EN 60079-14 (EU)

3.1 Precondition for use

3.1.3 Conformity with European directives

The CE mark on the device is a sign of conformity with the following European directives:

Electromagnetic compatibility EMC 2014/30/EU	Directive of the European Parliament and of the Council on the harmonization of the laws of the Member States relating to electromagnetic compatibility
Atmosphère explosible ATEX 2014/34/EU	Directive of the European Parliament and the Council on the harmonization of the laws of the Member States concerning equipment and protective systems intended for use in potentially explosive atmospheres
Pressure Equipment Directive PED 2014/68/EU	Directive of the European Parliament and of the Council on the harmonization of the laws of the Member States relating to the making available on the market of pressure equipment

The directives applied can be found in the EU declaration of conformity for the associated device.

3.1.4 Classification according to the pressure equipment directive

- For gases of fluid group 1 and liquids of fluid group 1; complies with requirements of article 4, paragraph 3 (sound engineering practice)
- Only for devices with MAWP 420 bar (6092 psi):  
For gases of Fluid Group 1 and liquids of Fluid Group 1; fulfills the basic safety requirements as per article 3, Para 1 (appendix 1); classified as category III, module H conformity evaluation by TÜV Nord

 <b>WARNING</b>
<b>Improper device modifications</b> Risk to personnel, system and environment can result from modifications to the device, particularly in hazardous areas. <ul style="list-style-type: none"><li>• Only carry out modifications that are described in the instructions for the device. Failure to observe this requirement cancels the manufacturer's warranty and the product approvals.</li></ul>

## 3.2 Requirements for special applications

Due to the large number of possible applications, each detail of the described device versions for each possible scenario during commissioning, operation, maintenance or operation in systems cannot be considered in the instructions. If you need additional information not covered by these instructions, contact your local Siemens office or company representative.

### Note

#### Operation under special ambient conditions

We highly recommend that you contact your Siemens representative or our application department before you operate the device under special ambient conditions as can be encountered in nuclear power plants or when the device is used for research and development purposes.

 <b>DANGER</b>
<b>Using equipment with approval-related restrictions</b>
Risk of explosion, damage to property due to operating conditions not in conformity with the approval (e.g. temperature and pressure limits exceeded)
<ul style="list-style-type: none"><li>• Take note of the approval restrictions before using the device. You can find the information on this in the current certificates.</li></ul>

### See also

Product documentation (Page 271)

## 3.3 Use in hazardous areas

### Qualified personnel for hazardous area applications

Persons who install, connect, commission, operate, and service the device in a hazardous area must have the following specific qualifications:

- They are authorized, trained or instructed in operating and maintaining devices and systems according to the safety regulations for electrical circuits, high pressures, aggressive, and hazardous media.
- They are authorized, trained, or instructed in carrying out work on electrical circuits for hazardous systems.
- They are trained or instructed in maintenance and use of appropriate safety equipment according to the pertinent safety regulations.

 <b>WARNING</b>
<b>Use in hazardous area</b>
Risk of explosion.
<ul style="list-style-type: none"><li>• Only use equipment that is approved for use in the intended hazardous area and labeled accordingly.</li><li>• Do not use devices that have been operated outside the conditions specified for hazardous areas. If you have used the device outside the conditions for hazardous areas, make all Ex markings unrecognizable on the nameplate.</li></ul>

**See also**

Technical data (Page 211)

 <b>WARNING</b>
<b>Loss of safety of device with type of protection "Intrinsic safety Ex i"</b>
If the device or its components have already been operated in non-intrinsically safe circuits or the electrical specifications have not been observed, the safety of the device is no longer ensured for use in hazardous areas. There is a risk of explosion.
<ul style="list-style-type: none"><li>• Connect the device with type of protection "Intrinsic safety" solely to an intrinsically safe circuit.</li><li>• Observe the specifications for the electrical data on the certificate and/or in Technical data (Page 211).</li></ul>

 <b>WARNING</b>
<b>Use of incorrect device parts in potentially explosive environments</b>
Devices and their associated device parts are either approved for different types of protection or they do not have explosion protection. There is a risk of explosion if device parts (such as covers) are used for devices with explosion protection that are not expressly suited for this type of protection. If you do not adhere to these guidelines, the test certificates and the manufacturer warranty will become null and void.
<ul style="list-style-type: none"><li>• Use only device parts that have been approved for the respective type of protection in the potentially explosive environment. Covers that are not suited for the "explosion-proof" type of protection are identified as such by a notice label attached to the inside of the cover with "Not Ex d Not SIL".</li><li>• Do not swap device parts unless the manufacturer specifically ensures compatibility of these parts.</li></ul>

 **WARNING****Use of the device with intrinsic safety "Ex i" type of protection in a polluted environment.**

If you open the device on the display side, there is a risk of pollution. The safety of the device for use in hazardous areas is therefore no longer guaranteed. There is a danger of explosion.

- Ensure that the environment is clean before rotating or replacing the display.

 **WARNING****Incorrect material for the diaphragm in Zone 0**

Risk of explosion in the hazardous area. If operated with intrinsically safe supply devices of category "ib" or devices of the flameproof enclosure version "Ex d" and simultaneous use in Zone 0, pressure transmitter explosion protection depends on the tightness of the diaphragm.

- Ensure that the material used for the diaphragm is suitable for the process medium. Refer to the information in the section "Technical data (Page 211)".

*3.3 Use in hazardous areas*



## Description

### 4.1 Area of application

Depending on the variant, the pressure transmitter measures corrosive, non-corrosive and hazardous gases, vapors and liquids.

You can use the pressure transmitter for the following measuring tasks:

- Gauge pressure
- Absolute pressure
- Differential pressure

With the appropriate configuration and the necessary add-on parts (e.g. limiters and remote seals), you can also use the pressure transmitter for the following measuring tasks:

- Level
- Volume flow
- Mass flow
- Volume
- Customized characteristic curve

The output signal for all measuring tasks is a direct current of 4 to 20 mA or a process-based, digital signal (e.g. with PROFIBUS PA).

You can install the "intrinsically-safe" or "flameproof enclosure" version of the pressure transmitter in hazardous areas. The devices have a test certification and comply with the corresponding directives.

Pressure transmitters with remote seals of various shapes can be provided for special applications. For example, measuring high-viscosity substances is a special application.

Operate the device in accordance with the specifications in section Technical data (Page 211).

#### Gauge pressure

This version measures aggressive, non-aggressive and hazardous gases, vapors and liquids.

There are two series: a "differential pressure" series and a "gauge pressure" series. The "differential pressure" series is distinguished by a high overload capability.

#### 4.1 Area of application

##### **Differential pressure and flow**

This version measures corrosive, non-corrosive and hazardous gases, vapors and liquids. You can use this version for the following measurement types:

- Differential pressure, e.g. effective differential pressure
- Gauge pressure, suitable for small positive or negative pressure value
- Together with a primary element

##### **Level**

This version with mounting flange measures the level of non-corrosive, corrosive and hazardous liquids in open and closed containers.

The nominal size of the mounting flange is DN 40 to DN 125 or 1 1/2" to 5".

The negative connection of the measuring cell is kept open when measuring the level of open containers. This measurement is referred to as "measurement against atmosphere". The negative connection is normally connected with the container when measuring the level of closed containers. This means the static pressure is present at both ends.

Wetted parts are made of various materials, depending on corrosion resistance requirements.

##### **Absolute pressure**

This version measures the absolute pressure of aggressive, non-aggressive and hazardous gases, vapors and liquids.

There are two series: a "differential pressure" series and a "gauge pressure" series. The "differential pressure" series is distinguished by a high overload capability.

## 4.2 Structure

Depending on the customer-specific order, the device comprises different parts.

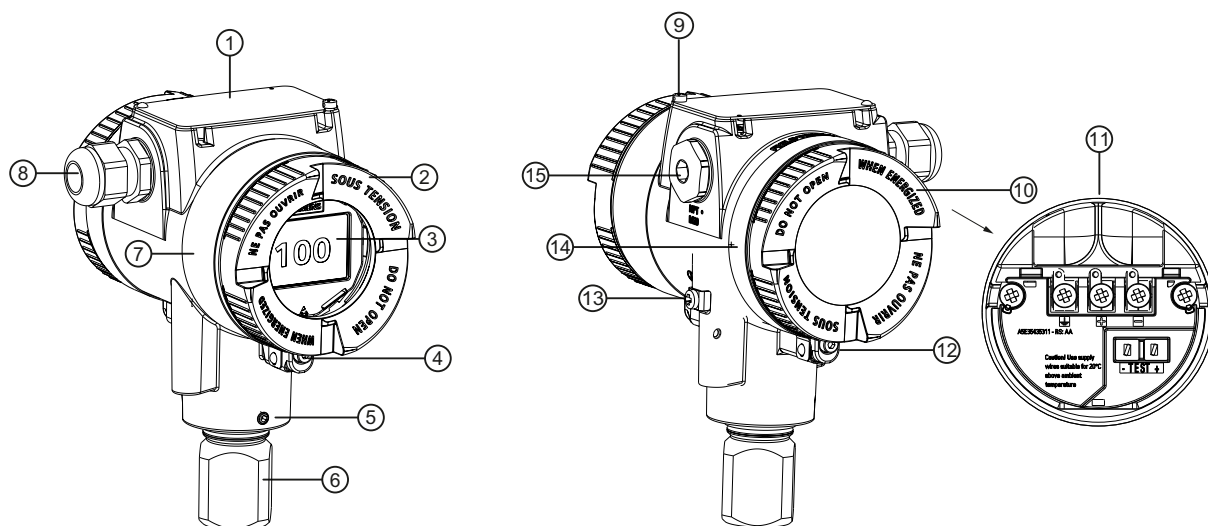

- |   |  |
|---|--|
| ① Cover over buttons and nameplate with general information | ⑨ Locking screw for the cover over the buttons     |
| ② Cover with glass pane (optional)                          | ⑩ Cover (rear) for electrical terminal compartment |
| ③ Display (optional)  | ⑪ Electrical terminal compartment                  |
| ④ Safety catch (front)                                      | ⑫ Safety catch (back)                              |
| ⑤ Retaining screw for locking the enclosure (Page 65)       | ⑬ Ground terminal                                  |
| ⑥ Process connection  | ⑭ Nameplate with information on the remote seal    |
| ⑦ Nameplate with approval information                       | ⑮ Blanking plug                                    |
| ⑧ Cable inlet, optionally with cable gland                  |  |

Figure 4-1 Example

- The electronics enclosure is made of die cast aluminum or precision cast stainless steel.
- The housing has a removable cover at the front and the back.
- Depending on the device version, the front cover (②) may be designed with a glass pane.
- The cable gland (⑧) to the electrical terminal compartment is at the side; either the left or right-hand one can be used. The unused opening is closed with a blanking plug (⑮).
- The ground terminal (⑬) is located on the side.
- The electrical terminal compartment (⑪) for the supply voltage and shield is accessible when you remove the back cover (⑩).
- The measuring cell with a process connection (⑥) is located in the lower section of the enclosure.  
The measuring cell is prevented from rotating by a retaining screw (⑤).
- The cover of the 4 buttons (①) is located on the upper face of the enclosure. The nameplate with general information is located on the cover.

## 4.3 Nameplate layout

### Nameplate with general information

The nameplate with the article number and other important information, such as design details and technical data, is located on the cover over the buttons.

#### Example

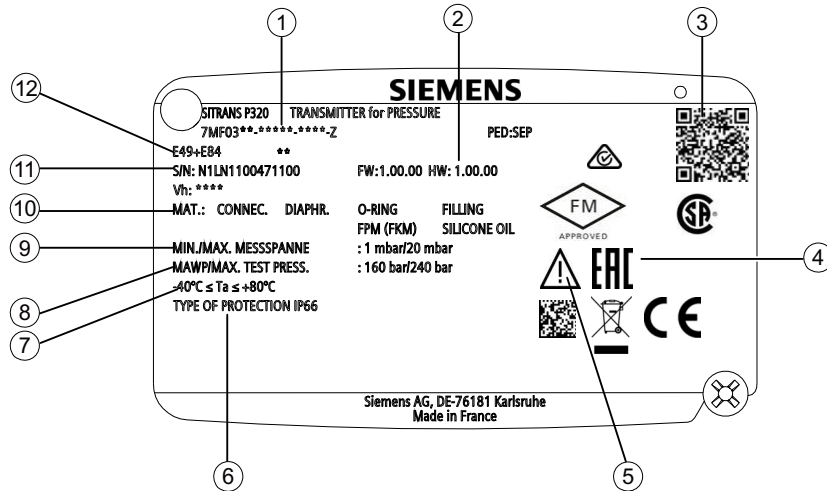

- |  |   |
|--|---|
| ① Article number (MLFB number)                                   | ⑦ Permitted ambient temperature for the hazardous area of the corresponding temperature class |
| ② Firmware and hardware identity                                 | ⑧ Maximum permissible operating pressure / maximum permissible test pressure                  |
| ③ QR code to the mobile website with device-specific information | ⑨ Minimum/maximum measuring span  |
| ④ Conformity with country-specific directives                    | ⑩ Material: Connection, diaphragm, O-ring, oil  |
| ⑤ Note operating instructions, certificates and approvals        | ⑪ Serial number   |
| ⑥ Protection class   | ⑫ Order supplement (order code)   |

### Nameplate with approval information

The nameplate with approval information is located on the front of the enclosure.

## Examples

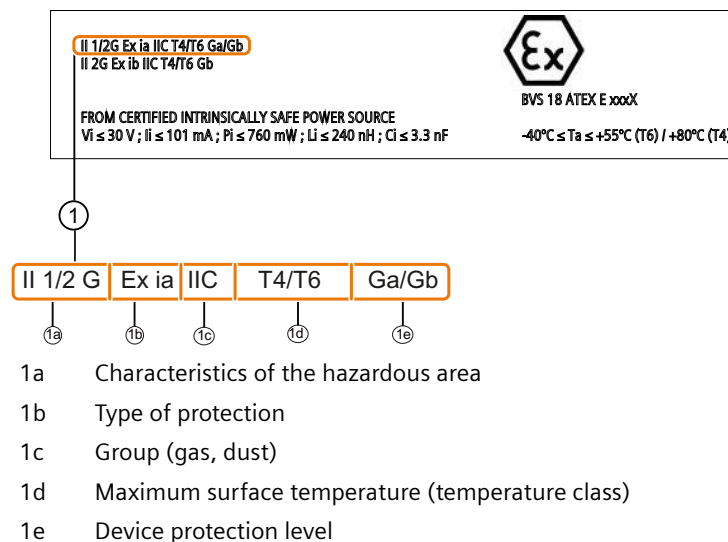

Figure 4-2 Example ATEX

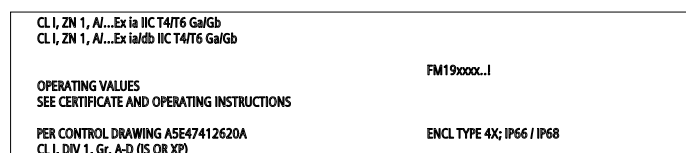
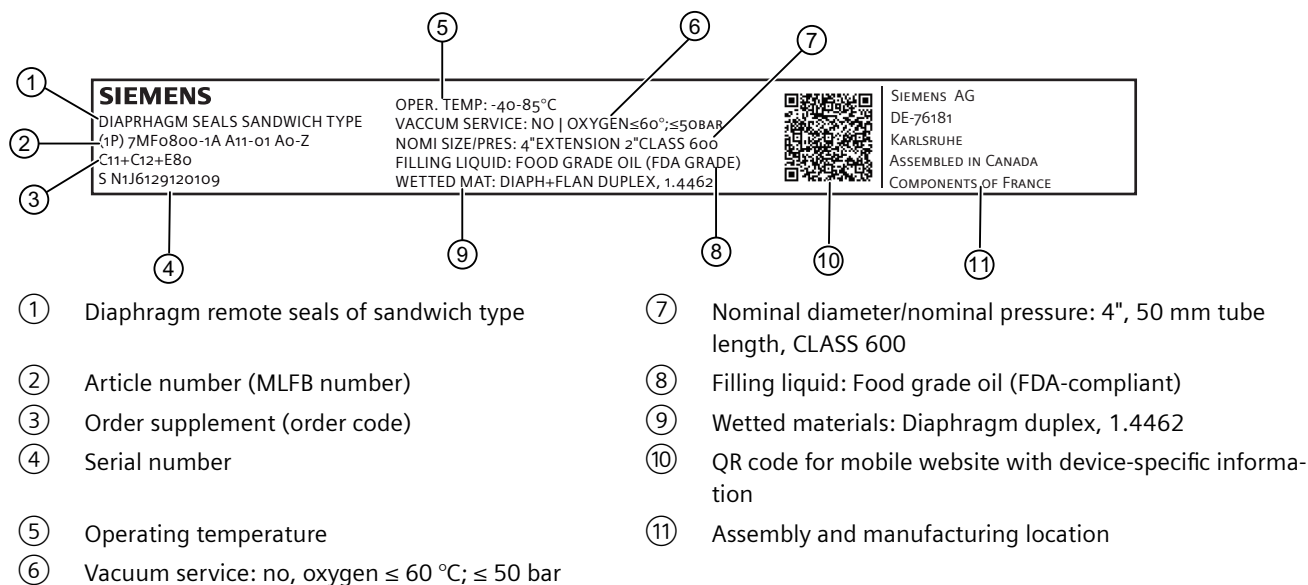

Figure 4-3 Example FM

## Nameplate with information on the remote seals

The nameplate with information on the remote seals is located on the back of the enclosure.

## Example



## 4.4 Tag plate

The tag plate is fastened with a wire under the front cover.

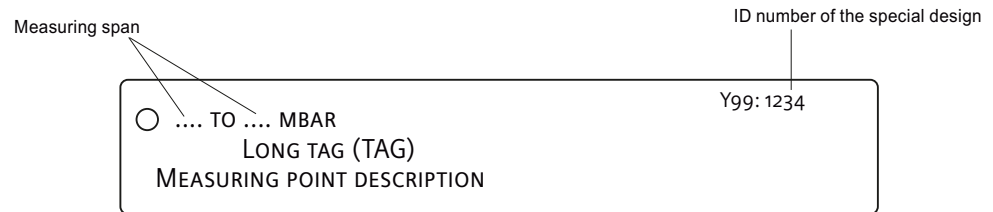

Figure 4-4 Example

## 4.5 Functional principle

This chapter describes how the pressure transmitter works.

First the electronics are described, and then the physical principle of the sensors which are used with the various device versions for the individual measurement types.

## 4.5.1 Electronics

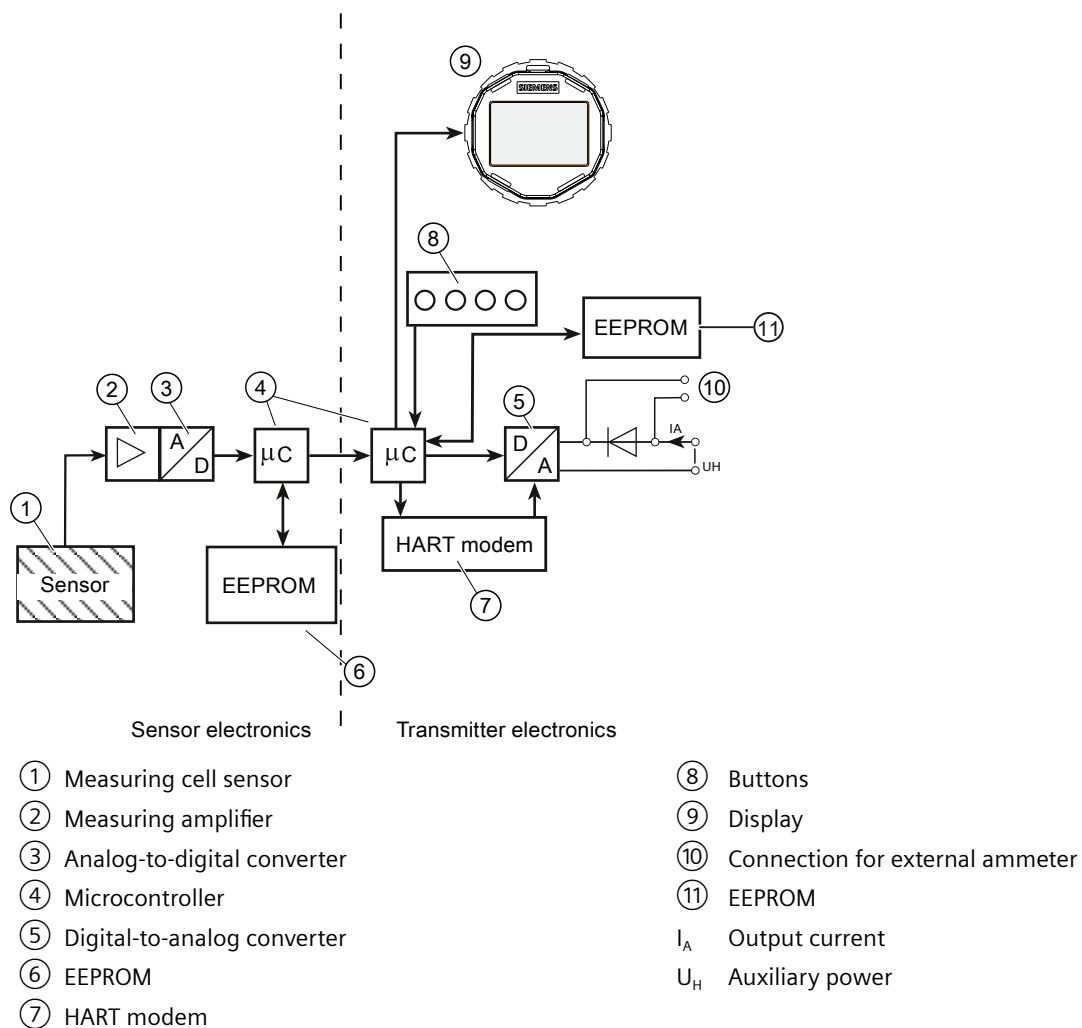

### Mode of operation

- The inlet pressure is converted into an electrical signal by the sensor ①.
- This signal is amplified by the measuring amplifier ② and digitized in an analog-to-digital converter ③.
- The digital signal is analyzed in a microcontroller ④ and corrected with regard to linearity and thermal characteristics.
- The digital signal is then converted in a digital-to-analog converter ⑤ into the output current of 4 to 20 mA.  
A diode circuit provides reverse polarity protection.

## 4.5 Functional principle

- You can make an uninterrupted current measurement with a low resistance ammeter at the connection ⑩.
- The measuring cell-specific data, electronics data and parameter assignment data are saved in two EEPROM modules. The first EEPROM module ⑥ is linked to the measuring cell, the second EEPROM module ⑪ to the electronics.

### 4.5.2 Measuring cell

The following modes of operation are described:

- Gauge pressure
- Absolute pressure
- Differential pressure and flow
- Level

The following process connections are available, for example:

- G1/2 B, 1/2-14 NPT
- Male thread: M20
- Flange connection in accordance with EN 61518
- Flush-mounted process connections

In the following sections, the process variable to be measured is generally called inlet pressure.

#### **WARNING**

##### **Destruction of the seal diaphragm**

Danger of injury or damage to device

If the seal membrane is destroyed, the sensor may also be destroyed. If the seal membrane is destroyed, no reliable measured values can be output.

Hot, toxic and corrosive process media can be released.

- Ensure that the material of the device parts wetted by the process medium is suitable for the medium. Refer to the information in section Technical data (Page 211).
- Make sure that the device is suitable for the maximum operating pressure of your system. Refer to the information on the nameplate and/or in Technical data (Page 211).
- Define maintenance intervals for regular inspections in line with device use and empirical values. The maintenance intervals will vary from site to site depending on corrosion resistance.



## 4.5.2.1 Measuring cell for gauge pressure

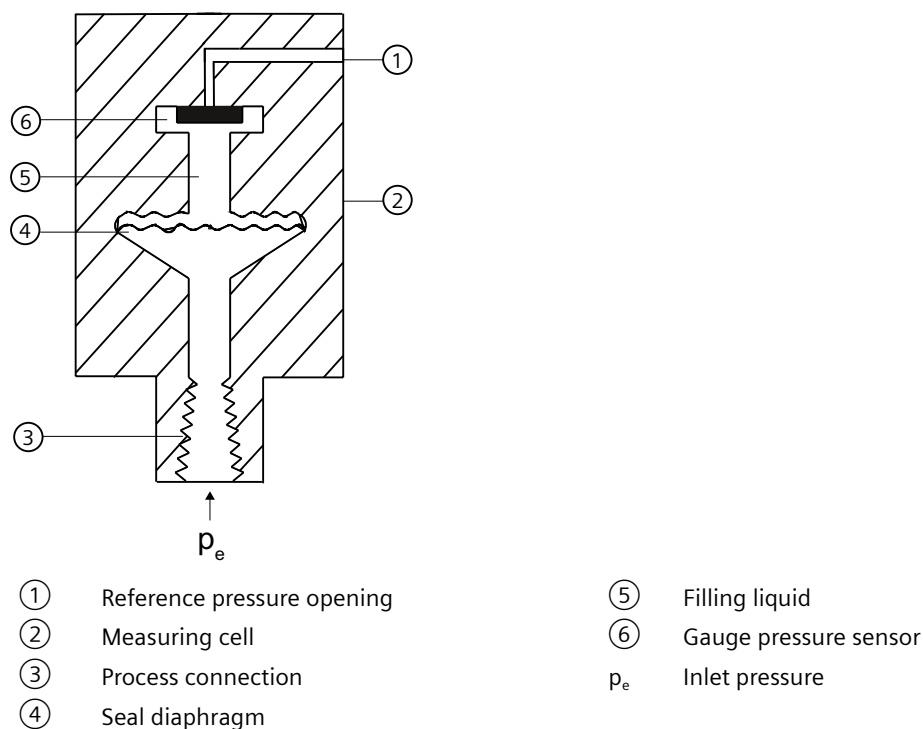

Figure 4-5 Function chart of measuring cell for gauge pressure

The inlet pressure ( $p_e$ ) is transferred to the gauge pressure sensor ⑥ via the seal diaphragm ④ and the fill fluid ⑤, displacing its measuring diaphragm. The displacement changes the resistance of the four piezoresistors (bridge circuit) of the gauge pressure sensor. The change in the resistance causes a bridge output voltage proportional to the inlet pressure.

Pressure transmitters with measuring span  $\leq 63$  bar measure the inlet pressure against atmosphere, those with measuring spans  $\geq 160$  bar the inlet pressure against vacuum.

4.5.2.2 Measuring cell for gauge pressure, front-flush membrane

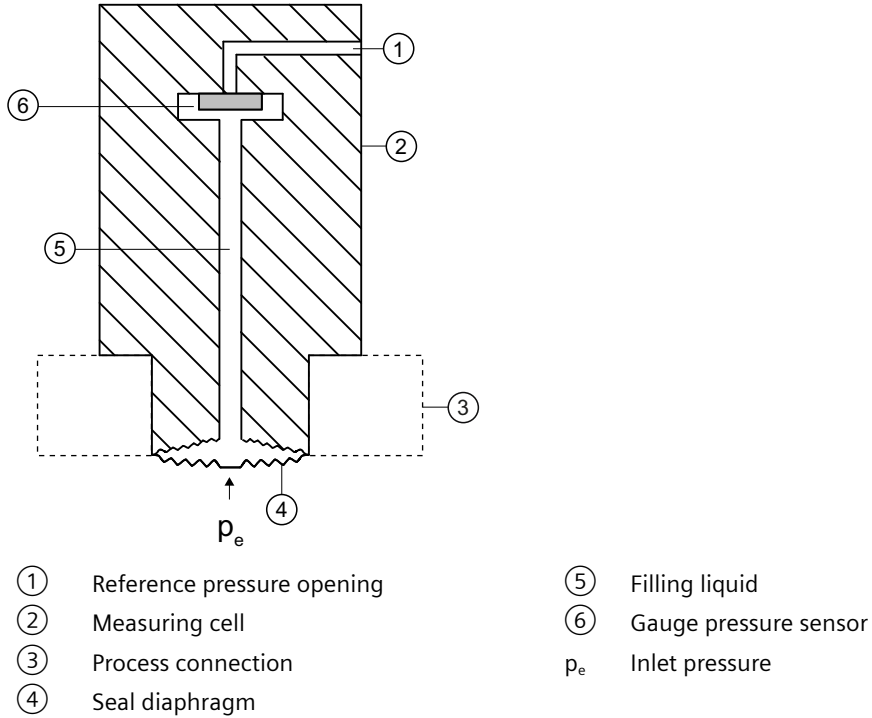
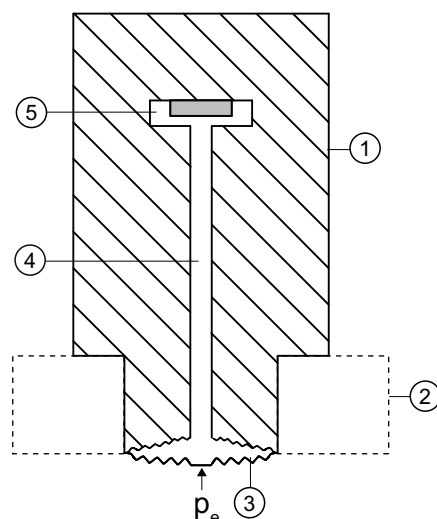

Figure 4-6 Function chart of the measuring cell for gauge pressure, flush mounted diaphragm

The inlet pressure ( $p_e$ ) is transferred to the gauge pressure sensor ⑥ via the seal diaphragm ④ and the filling liquid ⑤, displacing its measuring diaphragm. The displacement changes the resistance of the four piezoresistors (bridge circuit) of the gauge pressure sensor. The change in the resistance causes a bridge output voltage proportional to the inlet pressure.

Pressure transmitters with measuring span  $\leq 63$  bar measure the inlet pressure against atmosphere, those with measuring spans  $\geq 160$  bar the inlet pressure against vacuum.

### 4.5.2.3 Measuring cell for absolute pressure from the gauge pressure series



- |   |                    |       |                          |
|---|--------------------|-------|--------------------------|
| ① | Measuring cell     | ④     | Filling liquid           |
| ② | Process connection | ⑤     | Absolute pressure sensor |
| ③ | Seal diaphragm     | $P_e$ | Inlet pressure           |

Figure 4-7 Function chart of measuring cell for absolute pressure

- The inlet pressure ( $p_e$ ) is transferred to the absolute pressure sensor (⑤) via the seal diaphragm (③) and the fill fluid (④), displacing its measuring diaphragm.
- The displacement changes the resistance of the four piezoresistors (bridge circuit) of the absolute pressure sensor.
- The change in the resistance causes a bridge output voltage proportional to the inlet pressure.

## 4.5.2.4 Measuring cell for absolute pressure, front-flush membrane

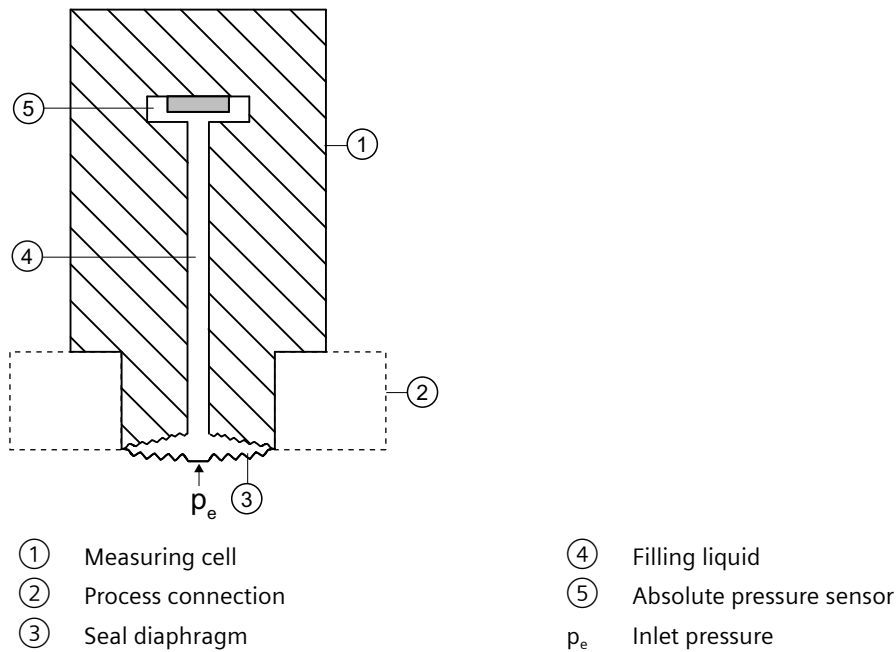
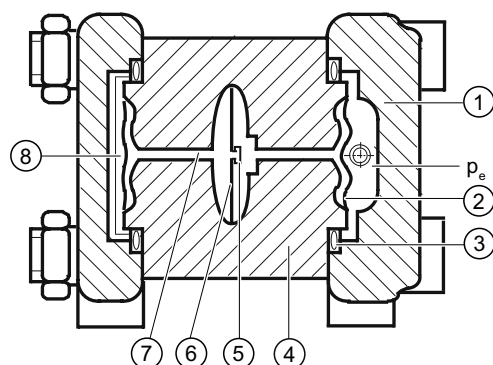

Figure 4-8 Function chart of the measuring cell for absolute pressure, flush mounted diaphragm

- The inlet pressure ( $p_e$ ) is transferred to the absolute pressure sensor ⑤ via the seal diaphragm ③ and the filling liquid ④, and displaces its measuring diaphragm.
- The displacement changes the resistance of the four piezoresistors (bridge circuit) of the absolute pressure sensor.
- The change in the resistance causes a bridge output voltage proportional to the inlet pressure.

#### 4.5.2.5 Measuring cell for absolute pressure from the differential pressure series



- |   |                                      |       |                               |
|---|--------------------------------------|-------|-------------------------------|
| ① | Pressure cap                         | ⑥     | Overload diaphragm            |
| ② | Seal diaphragm on the measuring cell | ⑦     | Measuring cell filling liquid |
| ③ | O-ring                               | ⑧     | Reference pressure            |
| ④ | Measuring cell body                  | $p_e$ | Pressure input variable       |
| ⑤ | Absolute pressure sensor             |       |                               |

Figure 4-9 Function chart of measuring cell for absolute pressure

- Absolute pressure is transmitted to the absolute pressure sensor ⑤ through the seal diaphragm ② and the filling liquid ⑦.
- When measuring limits are exceeded, the overload diaphragm ⑥ is displaced until the seal diaphragm ② rests on the measuring cell body ④. The seal diaphragm thus protects the absolute pressure sensor ⑤ from overload.
- The difference between the inlet pressure ( $p_e$ ) and the reference pressure ⑧ on the negative side of the measuring cell displaces the seal diaphragm ②. The displacement changes the resistance of the four piezoresistors (bridge circuit) of the absolute pressure sensor.
- The change in the resistance causes a bridge output voltage proportional to the absolute pressure.

## 4.5.2.6 Measuring cell for differential pressure and flow rate

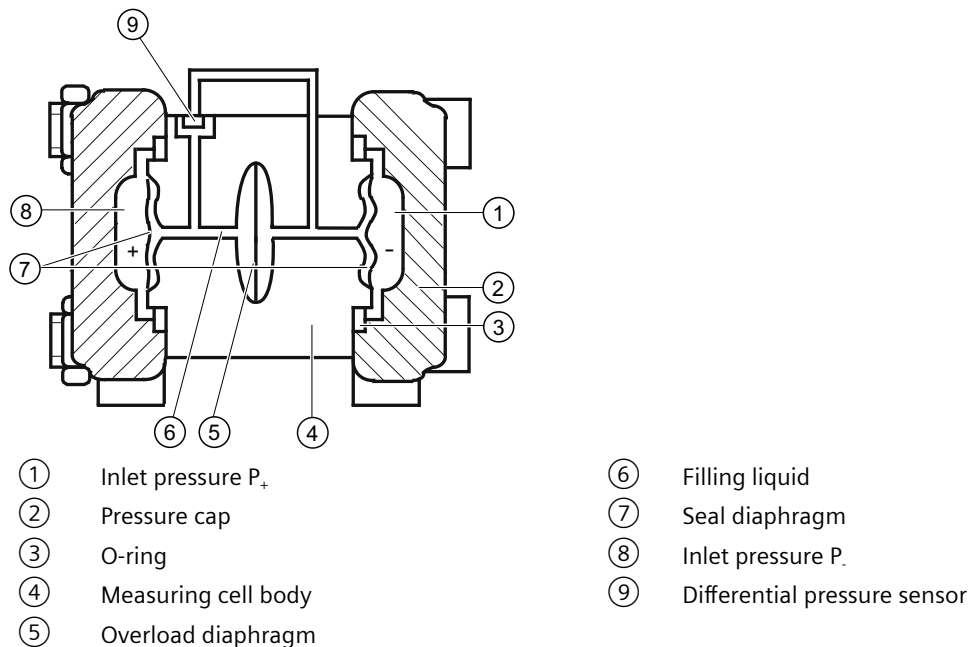
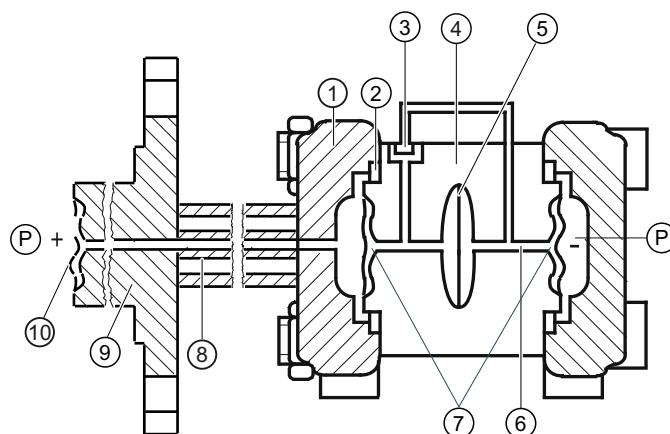

Figure 4-10 Function chart of the measuring cell for differential pressure and flow rate

- Differential pressure is transmitted to the differential pressure sensor (9) through the seal diaphragms (7) and the filling liquid (6).
- When measuring limits are exceeded, the seal diaphragm (7) is displaced until the seal diaphragm rests on the measuring cell body (4). The differential pressure sensor (9) is thus protected against overloading since no further deflection of the overload diaphragm (5) is possible.
- The seal diaphragm (7) is displaced by the differential pressure. The displacement changes the resistance of the four piezoresistors (bridge circuit) of the differential pressure sensor.
- The change in the resistance causes a bridge output voltage proportional to the differential pressure.

## 4.5.2.7 Measuring cell for level



P	Input pressure $P_+$ and $P_-$ .	⑥	Filling liquid of the measuring cell
①	Seal diaphragm on the measuring cell	⑦	Seal diaphragm on the measuring cell
②	O-ring	⑧	Capillary tube with the filling liquid of the mounting flange
③	Differential pressure sensor	⑨	Flange with a tube
④	Measuring cell body	⑩	Seal diaphragm on the mounting flange
⑤	Overload diaphragm		

Figure 4-11 Function chart of the measuring cell for level

- The input pressure (hydrostatic pressure) works hydraulically on the measuring cell through the seal diaphragm ⑨ on the mounting flange.
- The differential pressure at the measuring cell is transmitted to the differential pressure sensor ③ through the seal diaphragms ① and the filling liquid ⑥.
- When measuring limits are exceeded, the overload diaphragm ⑤ is displaced until one of the seal diaphragms ⑦ or ⑩ rests on the measuring cell body ④. The seal diaphragms ⑦ thus protect the differential pressure sensor ③ from overload.
- The seal diaphragm ⑦ is displaced by the differential pressure. The displacement changes the resistance of the four doped piezoresistors in the bridge circuit.
- The change in the resistance causes a bridge output voltage proportional to the differential pressure.

## 4.6 System configuration

The device can be used in a number of system configurations:

- As a stand-alone version, supplied with the necessary auxiliary power
- As part of a complex system environment, e.g. SIMATIC S7

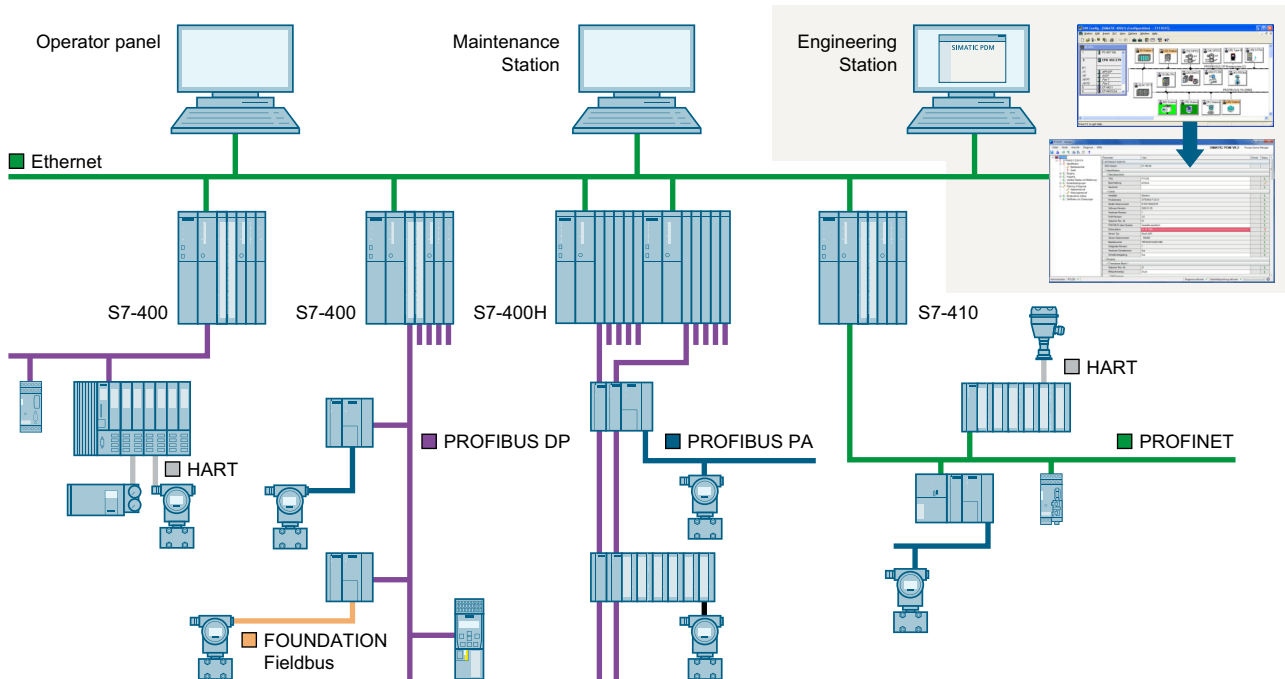

Figure 4-12 Example

### Communication via HART

You can configure and operate the device via HART:

- Via a HART Communicator (load 230 ... 1100  $\Omega$ )
- Via a PC with HART modem on which appropriate software is installed, e.g. SIMATIC PDM (load 230 ... 600  $\Omega$ )
- Via a control system which can communicate via the HART protocol, e.g. SIMATIC PCS7

---

#### Note

##### Devices with "intrinsically safe" type of protection

For an intrinsically safe supply, use only intrinsically safe HART Communicators (e.g. FC475) or intrinsically safe HART modems.

---



## 4.7 Remote seal and differential pressure flow measuring systems

### 4.7.1 Differential pressure - flow measuring systems

A differential pressure flow measuring system consists of the following components:

- Primary element, e.g. orifice or averaging pitot tube
- Shutoff fitting, valve manifold
- Pressure transmitter

Application examples for differential pressure and flow with primary elements, refer to section Differential pressure and flow rate (Page 96).

You can find additional information on primary elements in the associated instructions under: Manuals for SITRANS FP (<https://support.industry.siemens.com/cs/ww/en/ps/26040/man>)

### 4.7.2 Remote seals and primary element for devices with functional safety

Remote seals and primary elements were not included in the evaluation of the devices with respect to functional safety.

If you use a remote seal or a primary element, make sure that you include the associated safety characteristic values when evaluating your device with respect to functional safety.

For more information on evaluating the functional safety of your application, contact Technical Support.

*Description*

---

*4.7 Remote seal and differential pressure flow measuring systems*

# Installing/mounting

## 5.1 Basic safety instructions

 <b>DANGER</b>
<b>Pressure applications</b>
Danger to personnel, system and environment will result from improper disassembly.
<ul style="list-style-type: none"><li>• Never attempt to loosen, remove, or disassemble process connection while vessel contents are under pressure.</li></ul>

 <b>WARNING</b>
<b>Wetted parts unsuitable for the process media</b>
Risk of injury or damage to device.
Hot, toxic and corrosive media could be released if the wetted parts are unsuitable for the process medium.
<ul style="list-style-type: none"><li>• Ensure that the material of the device parts wetted by the process medium is suitable for the medium. Refer to the information in Technical data (Page 211).</li></ul>

 <b>WARNING</b>
<b>Unsuitable connecting parts</b>
Risk of injury or poisoning.
In case of improper mounting, hot, toxic, and corrosive process media could be released at the connections.
<ul style="list-style-type: none"><li>• Ensure that connecting parts (such as flange gaskets and bolts) are suitable for connection and process media.</li></ul>

 <b>WARNING</b>
<b>Exceeded maximum permissible operating pressure</b>
Risk of injury or poisoning.
The maximum permissible operating pressure depends on the device version, pressure limit and temperature rating. The device can be damaged if the operating pressure is exceeded. Hot, toxic and corrosive process media could be released.
Ensure that maximum permissible operating pressure of the device is not exceeded. Refer to the information on the nameplate and/or in Technical data (Page 211).

**⚠ WARNING**

**Incorrect material for the diaphragm in Zone 0**

Risk of explosion in the hazardous area. If operated with intrinsically safe supply devices of category "ib" or devices of the flameproof enclosure version "Ex d" and simultaneous use in Zone 0, pressure transmitter explosion protection depends on the tightness of the diaphragm.

- Ensure that the material used for the diaphragm is suitable for the process medium. Refer to the information in the section "Technical data (Page 211)".

**⚠ WARNING**

**Loss of safety for devices with "flameproof enclosure" type of protection**

Risk of explosion in hazardous areas. An explosion may be caused by hot gas escaping from the flameproof enclosure if there is too little space between it and fixed parts (e.g. walls, pipes).

- Ensure that there is a minimum clearance of at least 40 mm between the flameproof joints and the fixed parts.

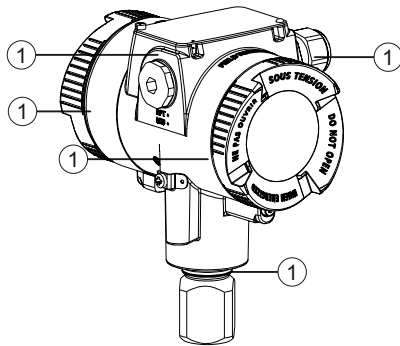

① Flameproof joint

**⚠ WARNING**

**Using safety extra-low voltage for devices of the protection type "db", "ec", "tb" or "tc"**

Risk of explosion in hazardous areas.

- Disconnect the non-intrinsically safe circuit safely from ground, e.g. using an SELV circuit.

 **WARNING**

**Vibrations in the plant**

Risk of injury or damage to device.

Vibration leads to material fatigue, for example, cracks and weld seams breaks.

Hot, toxic and corrosive process media can emerge.

- Make sure that you have mounted the pressure transmitter (including accessories) protected against vibration. Refer to the information on vibration resistance in the section Technical specifications (Page 211).

 **CAUTION**

**Hot surfaces resulting from hot process media**

Risk of burns resulting from surface temperatures above 65 °C (149 °F).

- Take appropriate protective measures, for example contact protection.
- Make sure that protective measures do not cause the maximum permissible ambient temperature to be exceeded. Refer to the information in Technical data (Page 211).

 **CAUTION**

**External stresses and loads**

Damage to device by severe external stresses and loads (e.g. thermal expansion or pipe tension). Process media can be released.

- Prevent severe external stresses and loads from acting on the device.

---

**Note**

**Material compatibility**

Siemens can provide you with support concerning selection of sensor components wetted by process media. However, you are responsible for the selection of components. Siemens accepts no liability for faults or failures resulting from incompatible materials.

---

### 5.1.1 Installation location requirements

<b>⚠ WARNING</b>
<b>Insufficient air supply</b>
The device may overheat if there is an insufficient supply of air.
<ul style="list-style-type: none"><li>• Install the device so that there is sufficient air supply in the room.</li><li>• Observe the maximum permissible ambient temperature. Refer to the information in the section Technical data (Page 211).</li></ul>

<b>NOTICE</b>
<b>Aggressive atmospheres</b>
Damage to device through penetration of aggressive vapors.
<ul style="list-style-type: none"><li>• Ensure that the device is suitable for the application.</li></ul>

<b>NOTICE</b>
<b>Direct sunlight</b>
Increased measuring errors.
<ul style="list-style-type: none"><li>• Protect the device from direct sunlight.</li></ul>
Make sure that the maximum ambient temperature is not exceeded. Refer to the information in the section Technical data (Page 211).

#### 5.1.1.1 Devices with marine approval

---

**Note**

For vibrations in the direction of the measuring cell diaphragm, the measuring accuracy of the pressure transmitter with flush-mounted diaphragm can deviate no more than 0.2% from the respective specification.

- Install the device so that no or almost no vibrations occur in the direction of the diaphragms.
- To avoid measuring values that fluctuate strongly, use the damping function.

For information on vibration resistance, refer to the marine approval certificate.

---

## 5.1.2 Proper mounting

 <b>WARNING</b>
<b>Incorrect mounting at Zone 0</b> Risk of explosion in hazardous areas. <ul style="list-style-type: none"><li>• Ensure sufficient tightness at the process connection.</li><li>• Observe the standard IEC/EN 60079-14.</li></ul>

<b>NOTICE</b>
<b>Incorrect mounting</b> The device can be damaged, destroyed, or its functionality impaired through improper mounting. <ul style="list-style-type: none"><li>• Before installing ensure there is no visible damage to the device.</li><li>• Make sure that process connectors are clean, and suitable gaskets and glands are used.</li><li>• Mount the device using suitable tools. Refer to the information in Technical data (Page 211).</li></ul>

<b>NOTICE</b>
<b>Use of line and cable entries made of plastic in hazardous areas</b> Device damage caused by impact at temperatures below -20 °C. <ul style="list-style-type: none"><li>• Make sure that the line and cable entries are protected from impacts.</li></ul>

## 5.2 Installation (except level)

### Before you mount the device

- Compare the operating data with the data on the nameplate of the pressure transmitter.
- Observe the minimum and maximum permissible ambient and medium temperature limits also under the influence of convection and heat radiation.
- Note the effect of the ambient temperature on the measuring accuracy in the section Technical data (Page 211).
- For remote seal mounting, observe the notes in the section "Mounting with remote seal" of the operating instructions.

### Mounting location

Verify that the mounting location meets the following conditions:

- Accessible
- Close to the measuring point

5.2 Installation (except level)

- Vibration-free
- Within the permitted ambient temperature values

Protect the pressure transmitter from:

- Direct heat radiation
- Sudden temperature fluctuations
- Heavy contamination
- Mechanical damage
- Direct sunlight

**Procedure**

1. Select the arrangement of the pressure transmitter depending on the aggregate state of the medium.

Gas	Vapor or liquid
Above the pressure sampling point	Below the pressure sampling point
Lay the pressure line with a constant gradient to the pressure sampling point, so that any condensation produced can drain in the main line and thereby avoid corruption of the measured values.	Lay the pressure line with a constant gradient to the pressure sampling point so that any gas pockets can escape in the main line.

2. Attach the pressure transmitter to the process connection.  
Use an appropriate tool (e.g. open-ended wrench with width across flats 36). Otherwise, the measuring cell may be damaged.
3. Turn only on the key area above the process connection.  
**Caution:** If you turn the pressure transmitter on the housing, the measuring cell may be damaged.



- For insulated systems, ensure that you insulate the device as far as possible to the lower edge of the enclosure.  
In this way, you avoid a defect in the device or the loss of explosion protection for Ex devices. You can find the permissible temperature values in the section Technical data (Page 211).

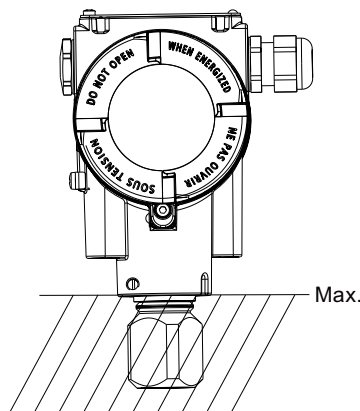

- To guarantee secure and vibration-free installation of the pressure transmitter, fasten it to a mounting bracket (Page 49).

### Level

You can find details on how to mount the device with level in the section Installation (level) (Page 51).

### See also

Remote seal measuring system (Page 56)

## 5.3 Securing the device with mounting bracket

Here you have the following mounting options with the mounting bracket:

- On a mounting range
- On a vertical or horizontal pipe ( $\varnothing$  50 to 60 mm), according to the examples 1 and 2

### Safety notes

#### NOTICE

#### Mounting with differential pressure lines

Differential pressure lines can break if they are not mounted correctly.

- Install the device so that the pressure transmitter and the differential pressure lines are not subject to different vibrations.

**NOTICE**

**Use of mounting bracket in maritime applications**

Device damages in case of vibration

- Secure the mounting bracket as shown in the figures.

**Note**

When securing the mounting bracket, observe the torques in the section Torques (Page 252).

**Example 1: Pipe mounting of pressure transmitter (gauge pressure series)**

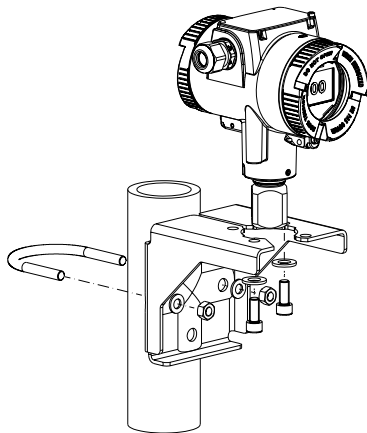

**Example 2: Pipe mounting of pressure transmitter (differential pressure series)**

The following positions are possible:

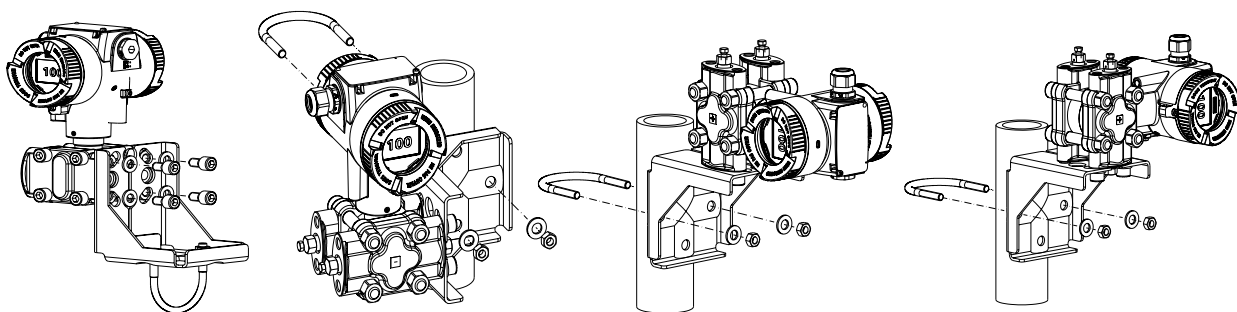

## 5.4 Mounting hygienic version

To avoid formation of steam, mount the pressure transmitter as follows, for example:

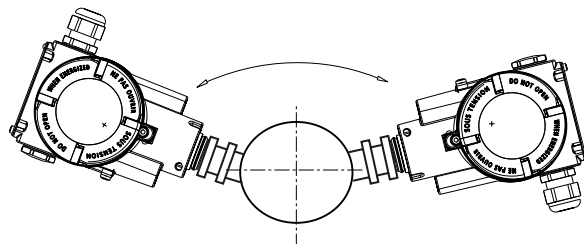

Figure 5-1 Correct installation

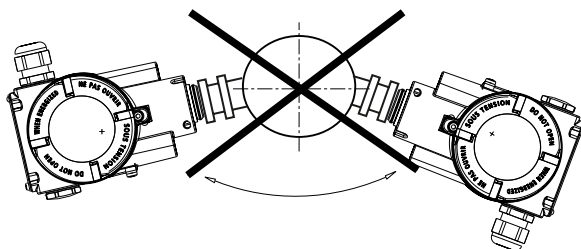

Figure 5-2 Incorrect installation

- Ensure that the length of the dead space at the end of the process connection is smaller than its diameter.
- To ensure optimal cleaning of the process plant, install the process connection without offset (flush-mounted on inside) in the plant.  
You can find additional information in the EHEDG Guidelines No. 10 and No. 37.

## 5.5 Installation (level)

### Before you mount the device

- Compare the operating data with the data on the nameplate of the pressure transmitter.
- Observe the minimum and maximum permissible ambient and medium temperature limits also under the influence of convection and heat radiation.
- Note the effect of the ambient temperature on the measuring accuracy in the section Technical data (Page 211).
- For remote seal mounting, observe the notes in the section "Mounting with remote seal" of the operating instructions.

### Mounting location

Verify that the mounting location meets the following conditions:

- Accessible
- Close to the measuring point

### 5.5 Installation (level)

- Vibration-free
- Within the permitted ambient temperature values

Protect the pressure transmitter from:

- Direct heat radiation
- Rapid temperature fluctuations
- Heavy contamination
- Mechanical damage
- Direct sunlight

---

#### Note

Select the height of the mounting flange such that the pressure transmitter is always mounted below the lowest fill height to be measured.

---

#### Procedure

1. Attach the seal to the container's mating flange.  
Ensure that the seal is centrally positioned and that it does not restrict the movement of the flange's seal diaphragm in any way. Otherwise, the seal of the process connection is not guaranteed to be tight.
2. Screw on the pressure transmitter's flange.
3. Observe the installation position.

#### See also

Remote seal measuring system (Page 56)

## 5.5.1 Mounting on the container

### Mounting on open container

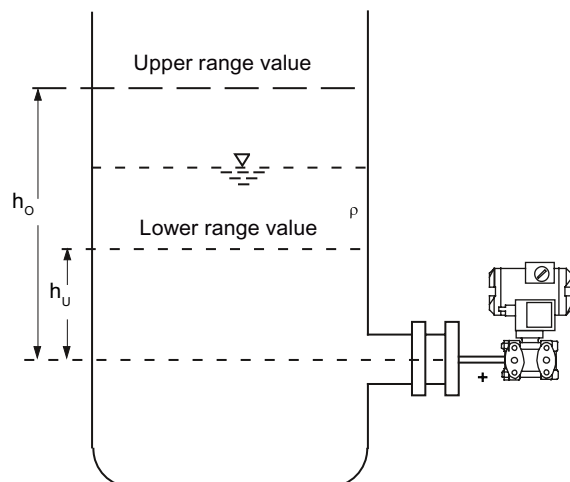

#### Formula

$$p_{MA} = \rho \cdot g \cdot h_U$$

$$p_{ME} = \rho \cdot g \cdot h_O$$

$h_U$  Lower filling level

$h_O$  Upper filling level

$p$  Pressure

$p_{LRV}$  Lower range value

$p_{URV}$  Upper range value

$\rho$  Density of the measured medium in the container

$g$  Acceleration due to gravity

A line is not required when taking measurements in an open container because the low pressure side is connected to the atmosphere.

Ensure that no dirt enters the open connection ports. To this end, use a threaded plug with vent valve 7MF4997-1CP, for example.

**Mounting on the closed container (no or little condensate formation)**

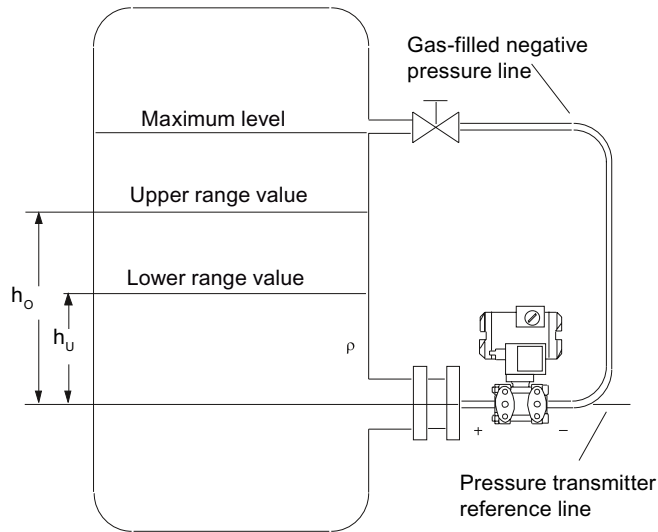

**Formula**

$$p_{MA} = \rho \cdot g \cdot h_U$$

$$p_{ME} = \rho \cdot g \cdot h_O$$

$h_U$  Lower filling level

$h_O$  Upper filling level

$\rho$  Pressure

$p_{LRV}$  Lower range value

$p_{URV}$  Upper range value

$\rho$  Density of the measured medium in the container

$g$  Acceleration due to gravity

When taking measurements in a closed container without or with little condensate formation, the low pressure line is not filled.

Lay the line in such a way that condensation pockets do not form. If required, you need to install a condensation container below the low pressure line of the pressure transmitter.

The process connection on the low pressure side is a female thread  $1/4$ -18 NPT or an oval flange.

Lay the line for the low pressure using a seamless steel tube 12 mm x 1.5 mm.

### Mounting on closed container (heavy condensate formation)

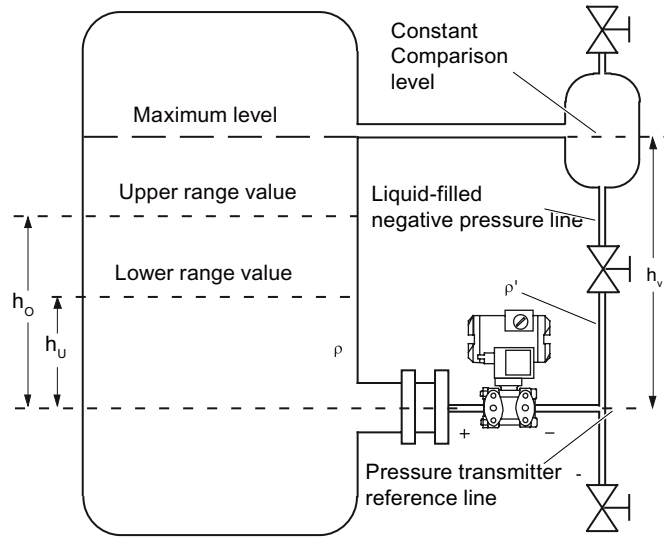

#### Formula

$$P_{MA} = g \cdot (h_U \cdot \rho - h_V \cdot \rho')$$

$$P_{MA} = g \cdot (h_O \cdot \rho - h_V \cdot \rho')$$

$h_U$  Lower filling level

$h_O$  Upper filling level

$h_V$  Gland distance

$p$  Pressure

$p_{LRV}$  Lower range value

$p_{URV}$  Upper range value

$\rho$  Density of the measured medium in the container

$\rho'$  Density of fluid in the low pressure line corresponds to the prevailing temperature there

$g$  Acceleration due to gravity

When taking measurements in a closed container with strong condensate formation, you must fill the low pressure line (mostly with the condensate of the measured medium) and install a condensate pot.

Lock the device using the 2-way valve manifold 7MF9017-..A.

To compensate the liquid column on the low pressure side, reset the zero point.

## 5.6 Installation with remote seal

### 5.6.1 Remote seal measuring system

The measuring system comprises the following components:

- Remote seal
- Transmission line, e.g. capillary line
- Pressure transmitter

---

#### Note

If you separate the components of the remote seal measuring system, this results in malfunctioning of the system.

Do not separate the components under any circumstances.

---

The capillary line and the remote seal diaphragm are the most sensitive components in the remote seal measuring system. The material thickness of the remote seal diaphragm is only ~ 0.1 mm.

The remote seal measuring system based on a hydraulic principle is used to transfer pressure.

The smallest of leakages in the transmission system leads to the loss of transmission fluid.

The loss of transmission fluid results in inaccuracies in the measurement and failure of the measuring system.

In order to avoid leaks and measuring errors, please observe the installation and maintenance instructions in addition to the safety notes.

### General information

- Keep the measuring system in the factory packing until it is installed in order to protect it from mechanical damage.
- When removing from the factory packing and installing: ensure that damage to and mechanical deformations in the membrane are prevented.
- Never loosen the sealed filling screws on the remote seal and the measuring instrument.
- Do not cause damage to the remote separating membrane; scratches on the remote separating membrane, e.g. due to sharp-edged objects, are the main starting points for corrosion.
- Select suitable gaskets for sealing.
- Use a gasket having an adequately large inner diameter for flanging. Insert the gasket concentrically; contact with the membrane leads to deviations in measurements.
- When using gaskets made of soft materials or PTFE: follow the guidelines of the gasket manufacturer, especially regarding the tightening torque and setting cycles.



- At the time of installation, use suitable fastening components such as screws and nuts that are compliant with fitting and flange standards.
- Excessive tightening of screwed joints on the process connection may displace the zero point on the pressure transmitter.

---

**Note****Commissioning**

When a shut-off valve exists, open the shut-off valve slowly when commissioning to avoid pressure surges.

---

**Note****Permissible ambient and operating temperatures**

- Observe the minimum and maximum permissible ambient and medium temperature limits also under the influence of convection and heat radiation.
  - Note the effect of the ambient temperature on the measuring accuracy in the section Technical data (Page 211).
  - The material and the pressure rating of the fittings and flange components must be suitable for the pressure and the temperature of your plant (or measuring arrangement).
  - The pressure rating specified on the remote seal is specified to reference conditions according to IEC 62828.
- 

**Using remote seals with pressure measuring device for hazardous areas:**

- When using remote seals with pressure transmitters in hazardous areas, the permissible ambient temperature limits for the pressure transmitter must not be exceeded. Hot surfaces on the cooling section (capillaries or cooling elements) are a possible source of ignition. Initiate suitable measures.
- When remote seals with a flame arrestor are used, the pressure measuring instrument determines the permissible ambient temperature. In the case of potentially explosive gaseous atmosphere, the temperature around the flame arrestor must not exceed +60 °C.

## 5.6.2 Remote seal with capillary line

### General information

- Do not transport the measuring assembly (pressure transmitter, flange and capillary line) by holding the capillary line.
- Do not bend the capillary lines. Otherwise there may be a leakage risk and the set-up time of the measuring system is increased.
- A mechanical overload at the connection points between capillary line and remote seal or between capillary line and pressure transmitter will lead to potential bending or breaking.
- Wind capillary lines that are too long with a radius of at least 300 mm.
- Fasten the capillary line such that there are no vibrations.

**Installation type for gauge pressure and level measurements (open containers)**

**Installation type A: Pressure transmitter above the measuring point**

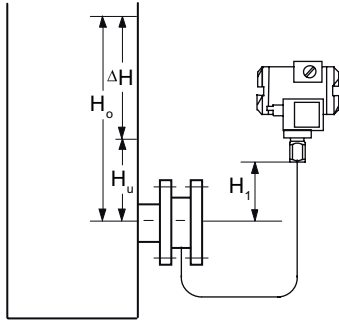

**Formula**

$$p_{MA} = \rho_{FL} * g * H_U - \rho_{oil} * g * H_1$$

$$p_{URV} = \rho_{FL} * g * H_O - \rho_{oil} * g * H_1$$

$p_{LRV}$  Lower range value

$p_{URV}$  Upper range value

$\rho_{FL}$  Density of the medium in the container

$\rho_{oil}$  Density of the filling oil in the capillary line of the remote seal

$g$  Acceleration due to gravity

$H_U$  Lower filling level

$H_O$  Upper filling level

$H_1$  Distance container flange to pressure transmitter

- In the case of remote seal measuring systems with silicone, glycerin or paraffin oil filling, the height difference ( $H_{1max}$ ) is  $\leq 7$  m.
- If halocarbon oil is used as the filling liquid, this maximum height difference is only  $\leq 4$  m.
- If a negative overpressure is observed during measurements, reduce the permissible height difference.

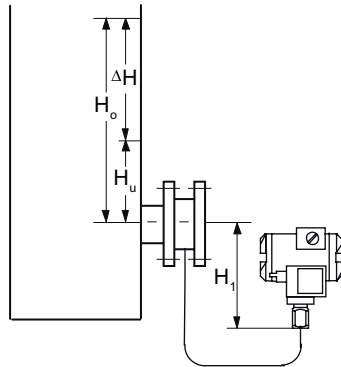
**Installation type B: Pressure transmitter below the measuring point****Formula**

$$p_{MA} = \rho_{FL} * g * H_U + \rho_{oil} * g * H_1$$

$$p_{ME} = \rho_{FL} * g * H_O + \rho_{oil} * g * H_1$$

$p_{LRV}$  Start of scale value

$p_{URV}$  Full-scale value

$\rho_{FL}$  Density of the process medium in the container

$\rho_{oil}$  Density of the filling oil in the capillary line of the remote seal

$g$  Acceleration due to gravity

$H_U$  Lower filling level

$H_O$  Upper filling level

$H_1$  Distance container flange to pressure transmitter

- In the case of remote seal measuring systems with silicone, glycerin or paraffin oil filling, the height difference ( $H_{1,max}$ ) is  $\leq 7$  m.
- If halocarbon oil is used as the filling liquid, this maximum height difference is only  $\leq 4$  m.

**Installation types for absolute pressure measurements (closed containers)**

For absolute pressure measurements (vacuum), install the pressure transmitter at least at the height of the remote seal or below the measuring point:

**Mounting type C: at the height of the remote seal**

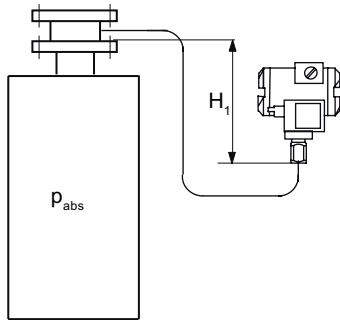

**Formula**

$$p_{MA} = p_{initial} + \rho_{oil} * g * H_1$$

$$p_{ME} = p_{final} + \rho_{oil} * g * H_1$$

$p_{LRV}$  Lower range value

$p_{URV}$  Upper range value

$p_{start}$  Initial pressure in the container

$p_{end}$  Final pressure in the container

$\rho_{oil}$  Density of the filling oil in the capillary line of the remote seal

$g$  Acceleration due to gravity

$H_1$  Distance container flange to pressure transmitter

**Mounting type D: below the measurement point**

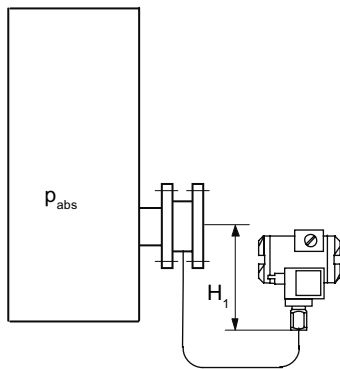

**Formula**

$$p_{MA} = p_{initial} + \rho_{oil} * g * H_1$$

$$p_{ME} = p_{final} + \rho_{oil} * g * H_1$$

$p_{LRV}$  Start of scale value

$p_{URV}$  Full-scale value

$p_{start}$  Initial pressure in the container

$p_{end}$  Final pressure in the container

$\rho_{oil}$  Density of the filling oil in the capillary line of the remote seal

$g$  Acceleration due to gravity

$H_1$  Distance container flange to pressure transmitter

$H_1 \geq 200 \text{ mm}$

## Mounting type for differential pressure and flow measurements

### Note

#### Effects of temperature

Keep the following instructions in mind to minimize the effects of temperature in remote seal measuring systems with differential pressure transmitter:

- Install the device so that the high pressure and low pressure sides are symmetrical as far as ambient effects and the ambient temperature are concerned.

### Mounting type E

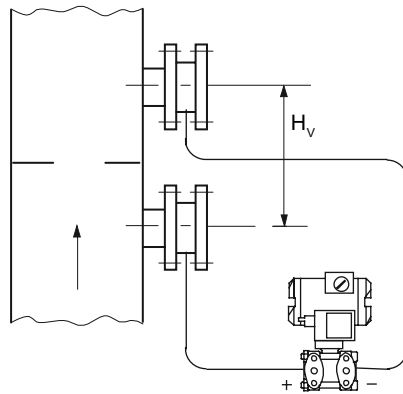

#### Formel

$$p_{MA} = p_{\text{initial}} - \rho_{\text{oil}} * g * H_V$$

$$p_{ME} = p_{\text{final}} - \rho_{\text{oil}} * g * H_V$$

$p_{LRV}$  Start of scale value

$p_{URV}$  Full-scale value

$p_{\text{start}}$  Initial pressure in the container

$p_{\text{end}}$  Final pressure in the container

$\rho_{\text{oil}}$  Density of the filling oil in the capillary line of the remote seal

$g$  Acceleration due to gravity

$H_V$  Gland distance

$H_1$  Distance container flange to pressure transmitter

## Installation types for level measurements (closed containers)

Reset the zero point after installation to compensate the liquid column on the minus side.

5.6 Installation with remote seal

This measure applies to the following installation types:

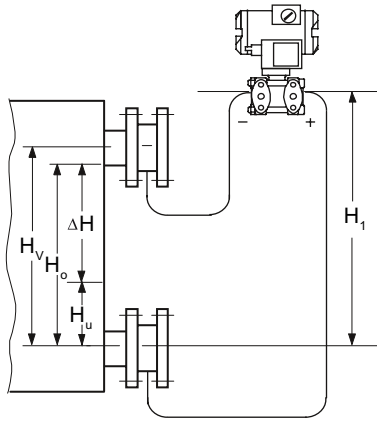

$H_1 \leq 7 \text{ m (23 ft)}$ ; with halocarbon oil as the filling liquid, only  $H_1 \leq 4 \text{ m (13.1 ft)}$

Start of scale value:

$$p_{LRV} = \rho_{FL} * g * H_U - \rho_{oil} * g * H_V$$

Full-scale value:

$$p_{URV} = \rho_{FL} * g * H_O - \rho_{oil} * g * H_V$$

Mounting type F

Pressure transmitter for differential pressure above the upper measuring point, no vacuum

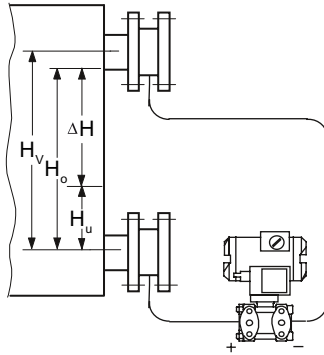

Start of scale value:

$$p_{LRV} = \rho_{FL} * g * H_U - \rho_{oil} * g * H_V$$

Full-scale value:

$$p_{URV} = \rho_{FL} * g * H_O - \rho_{oil} * g * H_V$$

Mounting type G

Below the lower measuring point

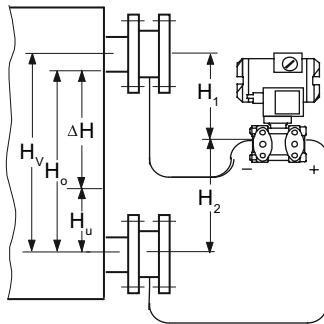

$H_2 \leq 7 \text{ m (23 ft)}$ ; with halocarbon oil as the filling liquid, only  $H_2 \leq 4 \text{ m (13.1 ft)}$

Start of scale value:

$$p_{LRV} = \rho_{FL} * g * H_U - \rho_{oil} * g * H_V$$

Full-scale value:

$$p_{URV} = \rho_{FL} * g * H_O - \rho_{oil} * g * H_V$$

Mounting type H

Between the measuring points, no vacuum

### Key

$p_{LRV}$	Start of scale value
$p_{URV}$	Full-scale value
$\rho_{FL}$	Density of the process medium in the container
$\rho_{oil}$	Density of the filling oil in the capillary line of the remote seal
$g$	Acceleration due to gravity
$H_U$	Lower filling level
$H_O$	Upper filling level
$H_V$	Gland distance
$H_1/H_2$	Distance container flange to pressure transmitter

## 5.7 Installing electrical connections and cable entries

The device is delivered with dust caps installed on both sides at the factory.

You use the order options starting with A to define the type of electrical connections and cable entries (cable gland, sealing plug or device plug) for your device.

These components are delivered with the device.

- To order the device with installed electrical connections and cable entries, select an additional order option for the installation (e.g. "device plug mounted on the right").

### Procedure

For the first installation follow these steps:

1. Ensure that the seals are clean and undamaged.
2. To ensure the IP degree of protection and explosion protection of the pressure transmitter, close the cable entries with a sealing plug, a cable gland or a device plug.

A description of how to replace electrical connections and cable entries is available in section Replacing electrical connections and cable entries (Page 195).

## 5.8 Rotating the display

To read the display in any mounting position, you have the option of gradually rotating the display 360°.

### Procedure

1. De-energize the device.
2. If available, loosen the front safety catch with a 3 mm Allen key.
3. Unscrew the front cover.

4. Remove the display from the holder.

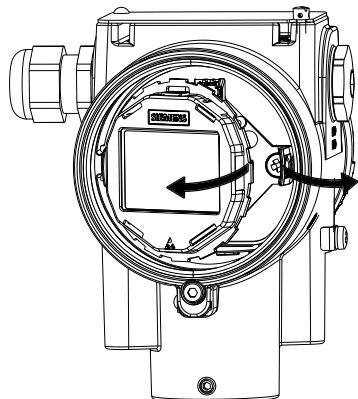

5. Leave the display cable plugged into the electronics.
6. Rotate the display to the desired position.

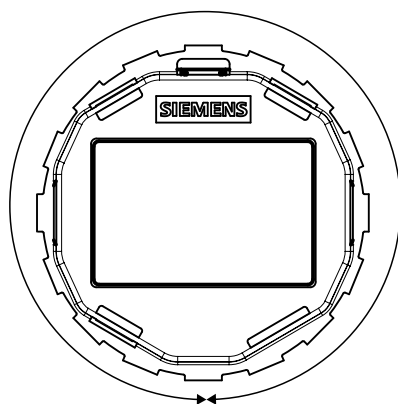

7. Press the display into the holder until it engages.

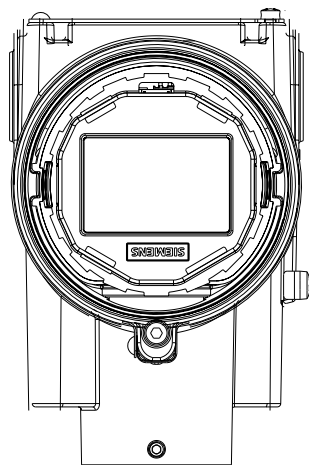



## 5.9 Rotating the enclosure

### Introduction

To make the device easier to operate in any mounting position, you have the option of adjusting the position of the enclosure within a range of 360°.

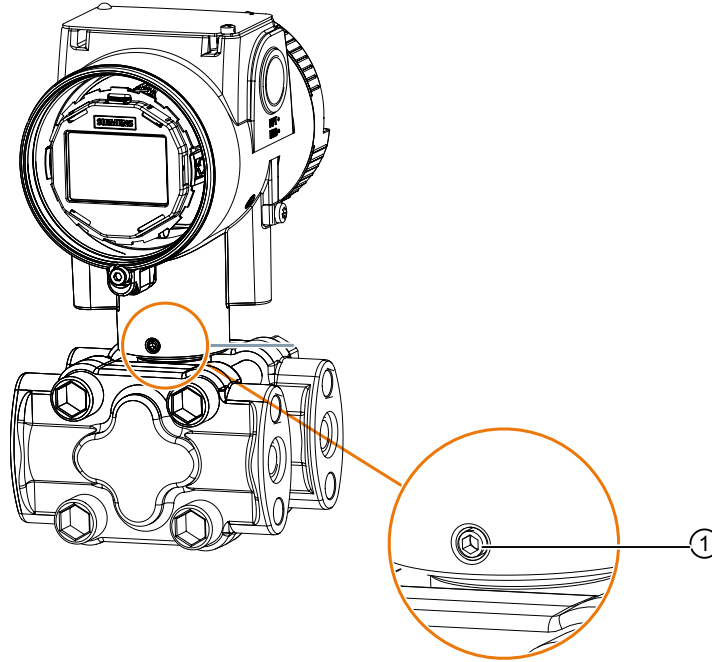

① Retaining screw

One retaining screw ① for the aluminum enclosure and two retaining screws (front and back) for the stainless steel enclosure prevent that the flat ribbon cable is damaged while rotating the enclosure.

The flat ribbon cable connects the sensor to the electronics.

The tightening torques of the retaining screws are different for the aluminum enclosure and the stainless steel enclosure. For the tightening torques of the retaining screws, refer to section Torques (Page 252).

### Tool

2.5 mm Allen key

### Rotating the aluminum enclosure

1. Loosen the retaining screw ① by half a rotation.
2. Rotate the enclosure to the desired position (but no further than the end stop).
3. Tighten the retaining screw.

### Rotating the stainless steel enclosure

1. Loosen the front retaining screw by half a rotation.
2. Loosen the back retaining screw by half a rotation.
3. Rotate the enclosure to the desired position (but no further than the end stop).
4. Tighten the front and back retaining screw.  
To prevent the enclosure from turning in case of vibration, make sure that the front and back retaining screw are tightened.

## 5.10 Removing

 **WARNING**

**Incorrect disassembly**

The following risks may result from incorrect disassembly:

- Injury through electric shock
- Risk through emerging media when connected to the process
- Risk of explosion in hazardous area

In order to disassemble correctly, observe the following:

- Before starting work, make sure that you have switched off all physical variables such as pressure, temperature, electricity etc. or that they have a harmless value.
- If the device contains hazardous media, it must be emptied prior to disassembly. Make sure that no environmentally hazardous media are released.
- Secure the remaining connections so that no damage can result if the process is started unintentionally.

# Connecting

## 6.1 Basic safety instructions

** WARNING****Unsuitable cables, cable glands and/or plugs**

Risk of explosion in hazardous areas.

- Use only cable glands/plugs that comply with the requirements for the relevant type of protection.
- Tighten the cable glands in accordance with the torques specified in Technical data (Page 211).
- Close unused cable inlets for the electrical connections.
- When replacing cable glands, only use cable glands of the same type.
- After installation, check that the cables are seated firmly.

** WARNING****Improper power supply**

Risk of explosion in hazardous areas as result of incorrect power supply.

- Connect the device in accordance with the specified power supply and signal circuits. The relevant specifications can be found in the certificates, in Technical data (Page 211) or on the nameplate.

** WARNING****Incorrect conduit system**

Risk of explosion in hazardous areas as result of open cable inlet or incorrect conduit system.

- In the case of a conduit system, mount a spark barrier at a defined distance from the device input. Observe national regulations and the requirements stated in the relevant approvals.

** WARNING****Unprotected cable ends**

Risk of explosion through unprotected cable ends in hazardous areas.

- Protect unused cable ends in accordance with IEC/EN 60079-14.

 <b>WARNING</b>
<b>Lack of equipotential bonding</b> Danger of explosion through compensating currents or ignition currents through lack of equipotential bonding. For devices of intrinsic safety "db", "ec", "tb" or "tc" which are operated in a non-intrinsically safe circuit, observe the following: <ul style="list-style-type: none"><li>• Connect the device to the system via the equipotential bonding terminal.</li></ul> <b>Note:</b> For devices of the intrinsic safety "ia", "ib" and "ic" type of protection, which are operated in an intrinsically safe circuit, connection to the system via the equipotential bonding terminal is not required.

 <b>WARNING</b>
<b>Improper laying of shielded cables</b> Risk of explosion through compensating currents between hazardous area and the non-hazardous area. <ul style="list-style-type: none"><li>• Shielded cables that cross into hazardous areas should be grounded only at one end.</li><li>• If grounding is required at both ends, use an equipotential bonding conductor.</li></ul>

 <b>WARNING</b>
<b>Connecting device in energized state</b> Risk of explosion in hazardous areas. <ul style="list-style-type: none"><li>• Connect devices in hazardous areas only in a de-energized state.</li></ul> <b>Exceptions:</b> <ul style="list-style-type: none"><li>• Devices having the type of protection "Intrinsic safety Ex i" may also be connected in energized state in hazardous areas.</li><li>• Exceptions for type of protection "Increased safety ec" (Zone 2) are regulated in the relevant certificate.</li></ul>

<p><b>⚠ WARNING</b></p> <p><b>Incorrect selection of type of protection</b></p> <p>Risk of explosion in hazardous areas.</p> <p>This device is approved for various types of protection.</p> <ol style="list-style-type: none"> <li>1. Select an intrinsic safety type of protection "ia", "ib", "ic" or non-intrinsic safety "db", "tb", "tc", "ec".</li> <li>2. Connect the device according to the selected type of protection.</li> <li>3. When operating with non-intrinsically safe power supplies, make the intrinsically safe types of protection permanently unrecognizable as in the nameplate example.</li> </ol>
--

<p>II 1/2G Ex ia IIC T4/T6 Ga/Gb II 1/2G Ex ia/db IIC T4/T6 Ga/Gb</p>
---

Figure 6-1 Nameplate example: Type 7MF0..0-.....-D..-Z + E20

<p><b>NOTICE</b></p> <p><b>Ambient temperature too high</b></p> <p>Damage to cable sheath.</p> <ul style="list-style-type: none"> <li>• At an ambient temperature <math>\geq 60</math> °C (140 °F), use heat-resistant cables suitable for an ambient temperature at least 20 °C (36 °F) higher.</li> </ul>
---

<p><b>NOTICE</b></p> <p><b>Condensation in the device</b></p> <p>Damage to device through formation of condensation if the temperature difference between transportation or storage and the mounting location exceeds 20 °C (36 °F).</p> <ul style="list-style-type: none"> <li>• Before taking the device into operation, let the device adapt for several hours in the new environment.</li> </ul>
--

<p><b>NOTICE</b></p> <p><b>Incorrect measured values with incorrect grounding</b></p> <p>The device must not be grounded using the "+" connection. It may otherwise malfunction and be permanently damaged.</p> <ul style="list-style-type: none"> <li>• If necessary, ground the device using the "-" connection.</li> </ul>
---

**Note****Electromagnetic compatibility (EMC)**

You can use this device in industrial environments, households and small businesses.

For metal housings there is an increased electromagnetic compatibility compared to high-frequency radiation. This protection can be increased by grounding the housing, see Technical data (Page 211).

**Note****Improvement of interference immunity**

- Lay signal cables separate from cables with voltages > 60 V.
- Use cables with twisted wires.
- Keep device and cables at a distance from strong electromagnetic fields.
- Take account of the conditions for communication specified in the Technical data (Page 211).
- Use shielded cables to guarantee the full specification according to HART/PA/FF/Modbus/EIA-485/Profibus DP.

## 6.2 Connecting the device

### 6.2.1 Opening the device

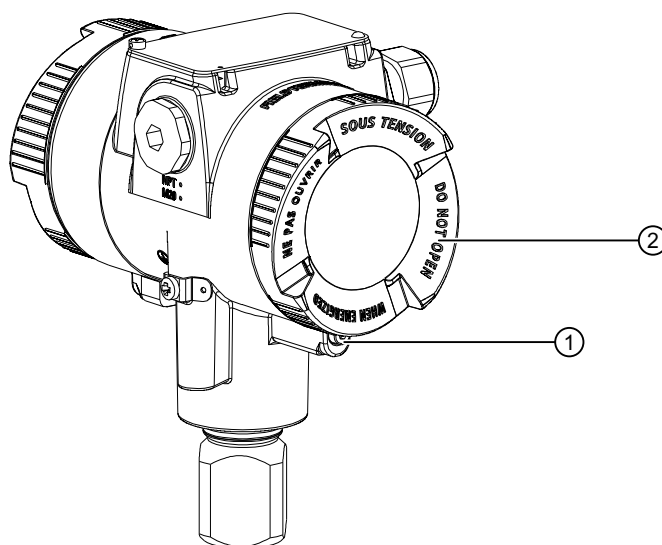

- ① Safety catch (optional)
- ② Cover of the electrical cable compartment.

Figure 6-2 Rear view of pressure transmitter

1. Use a 3 mm Allen key to loosen the safety catch ①.
2. Unscrew the cover of the electrical cable compartment ②.

## 6.2.2 Connecting the device

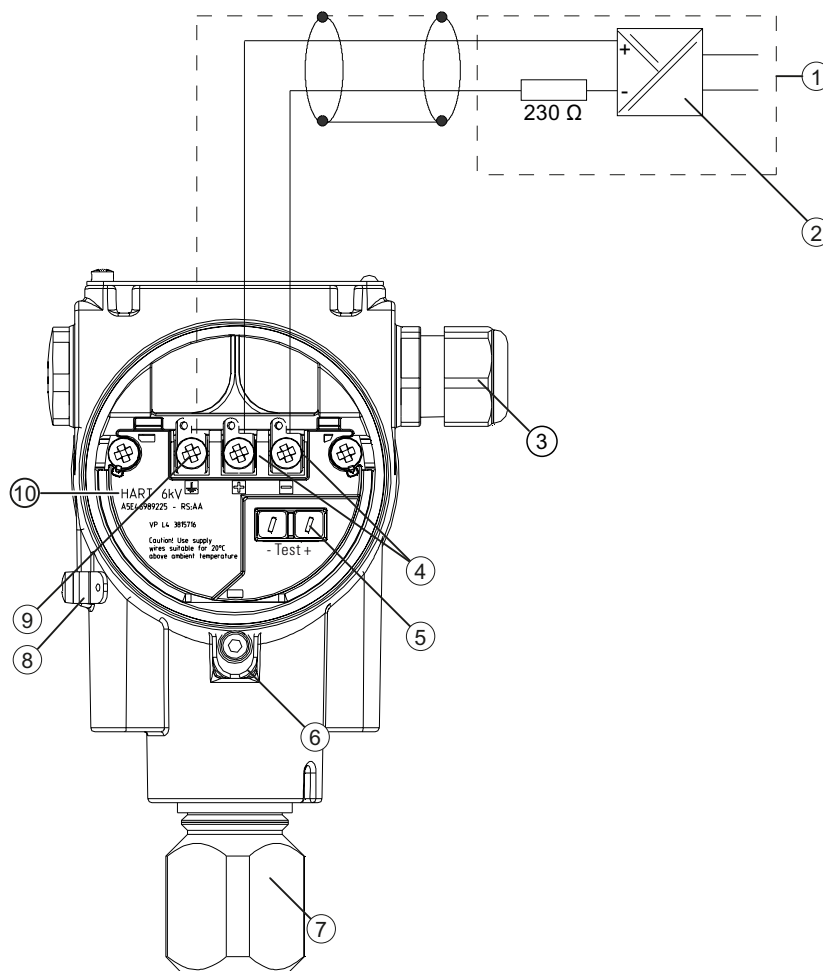

- |  |  |
|--|--|
| ① Supply unit with integrated load       | ⑥ Safety catch   |
| ② Supply voltage                         | ⑦ Process connection   |
| ③ Cable gland                            | ⑧ Protective conductor connector/<br>equipotential bonding terminal                          |
| ④ Connecting terminals                   | ⑨ Ground terminal  |
| ⑤ Test connector for DC measuring device | ⑩ Type of communication. Devices<br>with internal overvoltage protection<br>are marked here. |

Figure 6-3 Example: Electrical connection with supply unit

### Procedure

1. Connect the device to the system via the existing protective ground connection ⑧ by observing the torques.
  - Use a cable with a diameter of 1 ... 4 mm<sup>2</sup>.
2. Insert the connecting cable through the cable gland ③.
3. Connect the wires to the connection terminals ④ "+" and "-", observing the polarity and the torques.
  - Use wires with a diameter of 0.5 ... 2.5 mm<sup>2</sup>.
  - If you use stranded wire, you need ferrules.
4. Apply the shield to the screw of the ground terminal ⑨.  
The screw of the ground terminal is electrically connected to the external protective conductor connection.

<b>NOTICE</b>
<b>Incorrect measured values with incorrect grounding</b>
The device must not be grounded using the "+" connection. It may otherwise malfunction and be permanently damaged.
<ul style="list-style-type: none"><li>• If necessary, ground the device using the "-" connection.</li></ul>



5. For devices with intrinsically safe protection type, use a supply unit that corresponds to the requirements of the relevant type of protection.

### See also

Torques (Page 252)



### 6.2.3 Closing the device

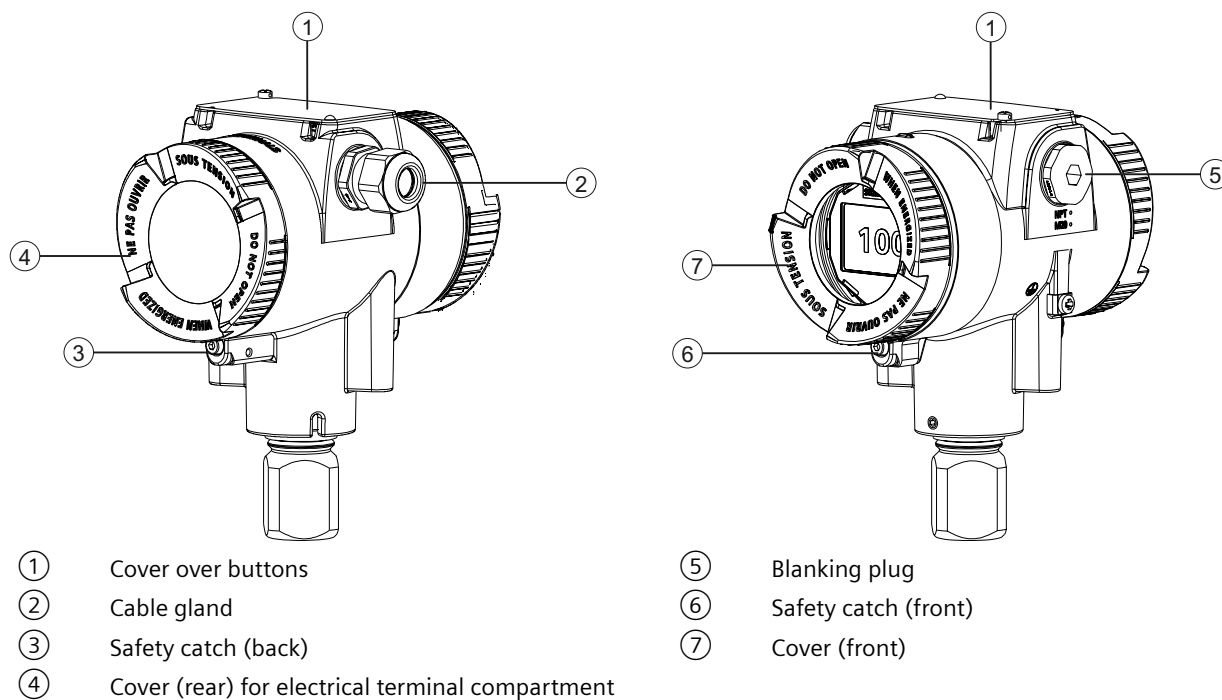

Figure 6-4 View of the pressure transmitter: Left: Back right: Front view

1. Screw on the cover (4) and (7) as far as it will go.  
Make sure that there is no gap between enclosure and cover.
2. Secure each cover with the cover catch (3) and (6) by removing the screw.  
For the aluminum enclosure, observe the torque (Page 252).
3. Close the cover over the buttons (1).
4. Tighten the screw for the cover over the buttons.

## 6.3 Connect the Han cable socket to the cable

### WARNING

#### Loss of the safety required for approval by using the Han plug

You may only use the Han plug for non-Ex devices and for devices with intrinsic safety "Ex i"; otherwise, the safety required for the approval is not guaranteed.

#### Note

Observe the protection class of the Han plug when defining the protection class.

The contact parts for the cable socket are supplied.

6.4 Connect M12 cable socket to the cable

For devices with a Han plug mounted on the enclosure, make the connection via the cable socket.

Requirement

- The terminal area of the cable socket is suitable for cables with diameters ranging from 6 to 12 mm.
- These cables use stranded wires with 1 mm<sup>2</sup> as single conductors ("+", "-" and ground).
- You are using a crimping tool from HARTING (article number 09 99 000 0110).

Procedure

1. Slide the sleeve and the screwed joint on the cable.
2. Strip approx. 8 mm of the cable ends.
3. Crimp the contact parts on the cable ends.
4. Assemble the cable socket.

Connector pin assignment with Han 7D or Han 8D plug or cable socket

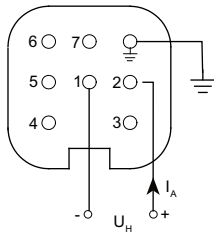

I<sub>A</sub>    Output current  
U<sub>H</sub>    Auxiliary power

6.4      Connect M12 cable socket to the cable

 <b>WARNING</b>
<b>Loss of safety required for approval by using the M12 device plug.</b>
You may only use the plug for non-Ex devices; otherwise, the safety required for the approval is not guaranteed.

**Note**

A conductive connection must not exist between the shield and the connector housing.

**Note**

Observe the protection class of the M12 device plug when defining the protection class.

In devices where a plug is already mounted on the enclosure, the connection is made via a cable socket.

1. Thread the parts of the cable socket as described by the manufacturer of the cable socket.
2. Strip approximately 18 mm of the bus cable ①.
3. Twist the shield.
4. Thread the shield in the insulating sleeve.
5. Draw 8 mm of shrink sleeve over the cable, wires and shield up to the reference edge ②.
6. Screw the cable ends and the shield in the pin insert.
7. Fasten the parts of the cable socket as described by the manufacturer.

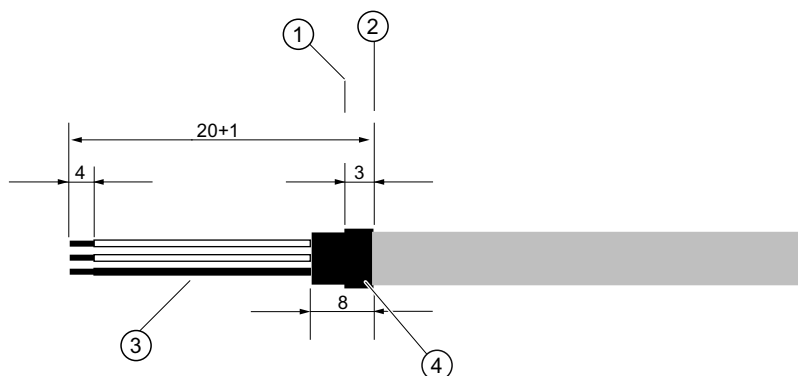
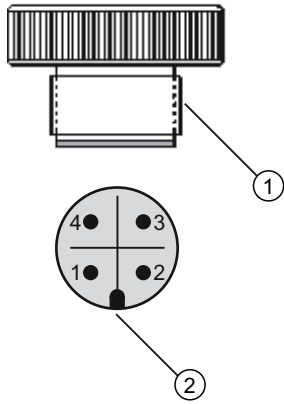

Figure 6-5 Preparing the connecting cable

- |   |  |   |                                   |
|---|--|---|-----------------------------------|
| ① | Reference edge for stripping                                       | ③ | Insulating sleeve over the shield |
| ② | Reference edge for the dimension specifications for cable assembly | ④ | Shrink sleeve                     |

**Assignment**



- Layout for M12 device plug
- ① M12 x 1 thread
  - ② Positioning catch
  - 1 +
  - 2 Not connected
  - 3 -
  - 4 Shield

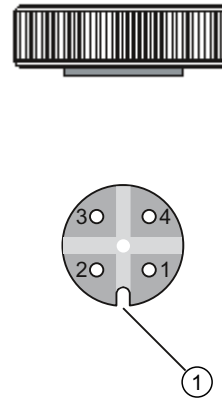

- Assignment diagram M12-cable socket
- ① Positioning slot
  - 1 +
  - 2 Not connected
  - 3 -
  - 4 Shield
- Middle contact of the cable socket not connected

## 6.5 Switching on the supply voltage

**Requirement**

- You have connected the device correctly. (Page 71)
- The terminal voltage on the device is correct. (Page 253)

**Procedure**

Switch on the supply voltage.

- Product name and firmware version appear briefly on the display.
- The measured values are shown on the display.  
For a device without a display, you read off the current output as follows:
  - Over the remote control (e.g. SIMATIC PDM).
  - With a DC current measuring device.

# Operating

You operate the device using the buttons.

If you have a device with a display, you can view the measured values, parameter values and messages.

If you have a device without a display, you also have several functions available:

Commissioning the device without display (Page 90)

## 7.1 Buttons

The four buttons are located below the cover:

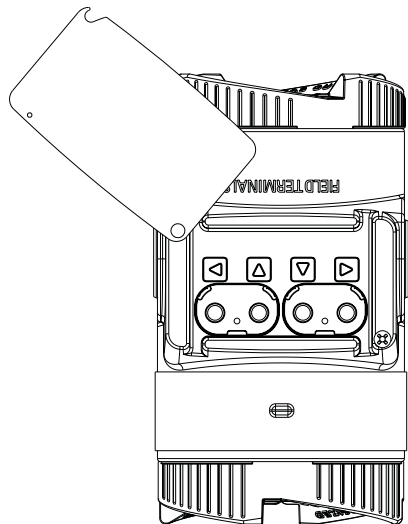

Figure 7-1 Top view

## 7.2 Operating the device with display

### 7.2.1 Navigating in the views

You navigate in the views with the buttons:

Buttons (Page 77)

Example

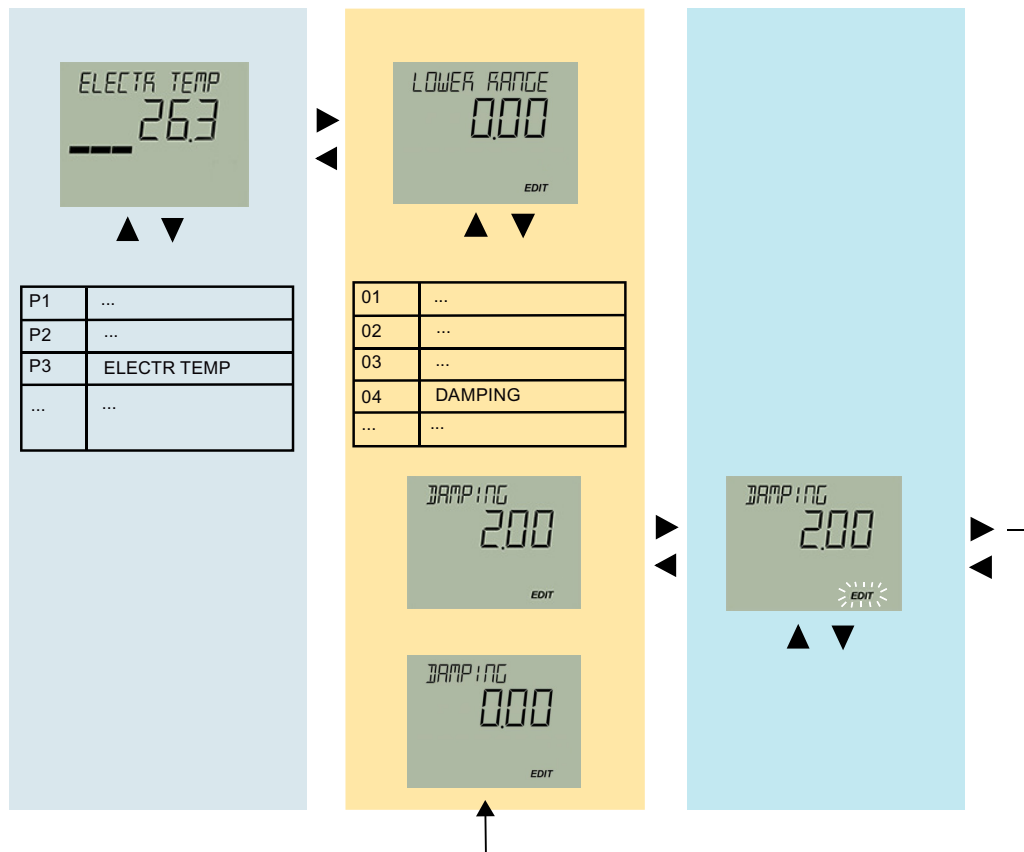

Figure 7-2 The colors represent three different views: Measured value view, parameter view and edit view

7.2.2 Measurement view

The measurement view shows the current measured values as well as status and diagnostic messages:



- ① Name and unit of the measured value (alternating)
- ② Measured value
- ③ Measured value ID
- ④ Bar display

Figure 7-3 Example

① shows the name of the measured value and the set unit as alternating values.

Measured value IDs ③ start with "P".

The bar display shows the following information:

- The position of a measured value within the set measuring span (e.g. pressure).
- The position of the temperature value within the sensor limits.
- The scaling of the process values calculated from the pressure value (e.g. volume flow).

### 7.2.2.1 Display of measured values

The following measured values are always displayed:

- Pressure (P1)
- Sensor temperature (P2)
- Electronics temperature (P3)
- Percent of range (P9)
- Loop current (PA)
- Terminal voltage (PB)

The following values are calculated from the measured pressure value and are displayed depending on your application:

- Level (P4)
- Volume (P5)
- Volume flow (P6)
- Mass flow (P7)
- Customized characteristic curve (P8)

Measured value ID	Name of measured value	Meaning
P1	PRESSURE	Pressure
	PRESS GAUGE	Gauge pressure
	PRESS ABS	Absolute pressure
P2	SENSOR TEMP	Sensor temperature
P3	ELECTR TEMP	Electronics temperature
P4	LEVEL	Level
P5	VOLUME	Volume
P6	VOLUME FLOW	Volume flow
P7	MASS FLOW	Mass flow
P8	USER DEFINED	Customized characteristic curve
P9	% OF RANGE	Percent of range
PA	LOOP CURRENT	Loop current
PB	CURR VOLTAGE	Terminal voltage

You use the "Start view" parameter [32] to select the measured value that is displayed as the first measured value in the measurement view.

Start view [32] (Page 144)

### 7.2.2.2 Navigating in the measurement view

#### Requirement

You have disabled the button lock.  
 Disabling button lock (Page 137)

#### Procedure

1. Use the ▲ and ▼ buttons to navigate in the measurement view.
2. To switch to the parameter view, press the ► button.

### 7.2.3 Parameter view

The parameter view shows the parameters, parameter values and the wizards of the device.

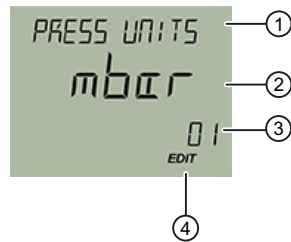

- ① Name and unit of the parameter (alternating)
- ② Parameter value
- ③ Parameter ID
- ④ "EDIT" symbol (permanently enabled)

Figure 7-4 Example of parameter view

For parameters with an associated unit, the parameter name and unit are displayed as alternating values in ①. Example: Pressure units in mbar.

#### 7.2.3.1 List of parameters on the display

The parameters are displayed with parameter ID and parameter name.  
 Depending on the parameter settings of your device, some parameters are not visible.

Parameter ID	Parameter name on the display	Meaning
01	PRESS UNITS	Pressure units (Page 108)
02	LOWER RANGE	Set lower range value (without pressure applied) (Page 110)
03	UPPER RANGE	Set upper range value (without pressure applied) (Page 110)



Parameter ID	Parameter name on the display	Meaning
04	DAMPING	Damping value (Page 112)
05	APPLICATION	Application <sup>1)</sup> (Page 112)
06	SQRT POINT	Application point for volume flow and mass flow (VSLN and MSLIN) (Page 121)
07	ZERO POINT	Zero point adjustment (Page 122)
08	APPLY LRV	Apply lower range value (with pressure applied) (Page 124)
09	APPLY URV	Apply upper range value (with pressure applied) (Page 124)
10	FAULT CURR	Select fault current (Page 126)
11	LO FAULT CUR	Lower fault current (Page 126)
12	UP FAULT CUR	Upper fault current (Page 127)
13	SATURAT LOW	Lower saturation limit (Page 127)
14	SATURAT HIGH	Upper saturation limit (Page 128)
15	SV SELECT	SV selection, set secondary variable (Page 129)
16	LEVEL UNITS	Level unit (Page 129)
16	VOL UNITS	Volume units (Page 129)
16	VFLOW UNITS	Volume flow units (Page 129)
16	MFLOW UNITS	Mass flow units (Page 129)
17	TEMP UNITS	Temperature units for sensor and electronics temperature (Page 132)
18	LOWER SCALNG	Lower scaling point (Page 132)
19	UPPER SCALNG	Upper scaling point (Page 133)
20	LOW FLOW CUT	Low flow cut-off for volume flow and mass flow (VSOFF and MSOFF) (Page 134)
21	VESSEL DIM A	Vessel dimension A (Page 135)
22	VESSEL DIM L	Vessel dimension L (Page 135)
23	BUTTON LOCK	Enable and disable button lock (Page 136)
24	CHANGE PIN	Change user PIN (Page 137)
25	RECOVERY ID	Display Recovery ID (Page 138)
26	PIN RECOVERY	PIN recovery (Page 139)
27	USER PIN	Enable and disable user PIN (Page 140)
28	DEVICE MODE	Active device mode (Page 142)
29	FUNCT SAFETY	Enable and disable Functional Safety (Page 142)
30	DISPLAY TEST	Display test (Page 142)
31	LOOP TEST	Loop test (Page 143)
32	START VIEW	Start view (Page 144)
33	PRESSURE REF	Pressure reference (Page 145)
34	IDENTIFY	Identify the device (Page 145)
35	RESET	Reset (Page 146)
36	OVERLD BEHAV	Overload behavior (Page 147)

1) The "Application" parameter is also called the "Transfer function" in certain configuration tools.

Hereinafter, the parameter ID is always written inside parentheses after the parameter name.  
Example: Parameter "Damping value" [04].

**See also**

Parameter assignment over device with display (Page 108)

**7.2.3.2 Navigating in the parameter view**

**Requirement**

The button lock is disabled.

Disabling button lock (Page 137)

**Procedure**

1. Use the ▲ or ▼ buttons to navigate within the parameters.  
To navigate faster, keep the ▲ or ▼ button pressed.  
After the last parameter, you jump to the first parameter, and vice versa.
2. To switch to edit view, press the ► button.
3. To return to the measurement view, press the ◀ button.

**7.2.4 Edit view**

You change the parameter values in the edit view. Wizards are available for specific parameters.

**Parameter values**

There are various parameter values:

- Enumerations (e.g. unit)
- Numerical values (e.g. damping)

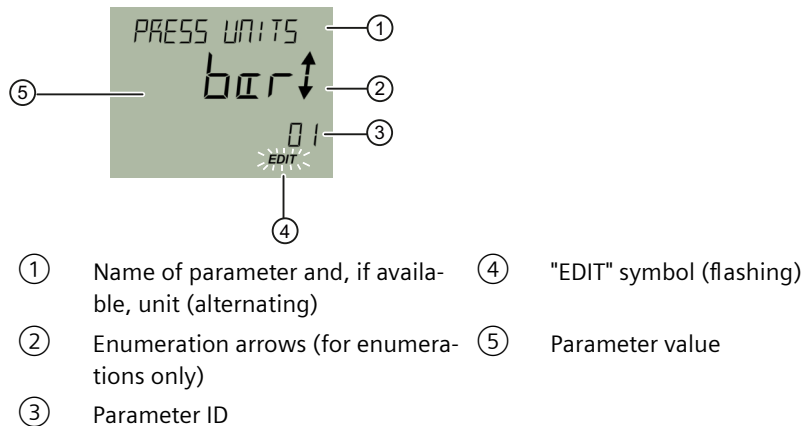

Figure 7-5 Example of edit view

For parameters with an associated unit, the parameter name and unit are displayed as alternating values in ①. Example: Pressure units in mbar.

### 7.2.4.1 Changing parameter values

#### Requirement

The device is not write-protected.

For information on write protection, refer to section Locking the device (Page 84).

#### Procedure

1. Navigate to the parameter view (Page 77).
2. Select the desired parameter with the ▲ or ▼ button.  
Use the ► button to confirm.  
You are in the edit view.
3. Change the parameter value with the ▲ or ▼ button.  
To navigate faster, keep the ▲ or ▼ button pressed.
4. Save the change with the ► button.  
Or, cancel the change with the ◀ button.

### 7.2.5 Device status display

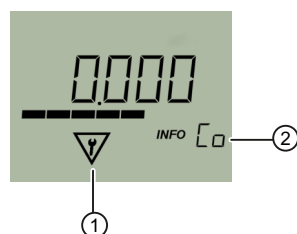

- ① Symbol - NAMUR NE 107
- ② Diagnostics ID

Figure 7-6 Example

For additional information about symbols and the diagnostic messages, refer to Diagnostics and troubleshooting (Page 199).

## 7.3 Remote operation

You can operate the device using HART communication. The following is required for this purpose:

- A handheld (e.g. FC475) or PC software such as SIMATIC PDM.
- A HART modem to connect a PC with the device or a lead to connect the handheld with the device.

**See also**

SIMATIC PDM (Page 273)

## 7.4 Locking the device

### 7.4.1 Write protection

The following options are available to lock the device:

- Enable write protection using the jumper.
- Enable write protection using the user PIN.
- Enable write protection using the button lock.

Write protection	Sym- bol	ID	Read measured values on the display	Read parameters on the display	Change parameters via the device with display
Jumper set		L	Yes	No	No
User PIN <sup>1)</sup> enabled		LP	Yes	Yes	Yes, after input of the user PIN
Button lock enabled		LL	Yes	No	No

<sup>1)</sup>The user PIN is factory set to 2457 in the device. When delivered, write protection is disabled using the user PIN.

#### Devices with functional safety

To enable functional safety, you first enable the user PIN.

### 7.4.2 Enable write protection with jumper

The jumper is used for enabling write protection.

When write protection is enabled with the jumper:

- Measured values are read-only.
- The display changes automatically between the measured values.
- Operation via the buttons is disabled.

#### Procedure

1. De-energize the device.
2. Use a 3 mm Allen key to loosen the front safety catch.
3. Remove the front cover connector of the device.

4. Remove the display from the holder.

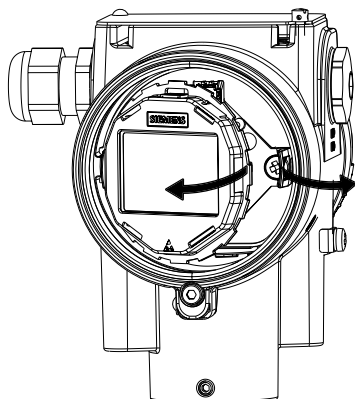

5. Disconnect the cable of the display from the 4-pole connector ①.

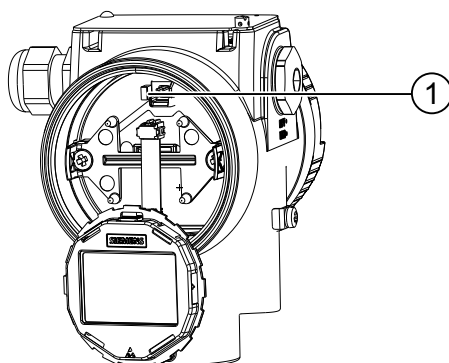

Write protection is disabled (e.g. as factory setting)	Write protection is enabled

### 7.4.3 Enable user PIN

#### Requirement

The User PIN is disabled.

**Procedure**

1. Navigate to the parameter view.  
Navigating in the views (Page 77)
2. Select the parameter "User PIN".
3. Use the ► button to confirm.  
The message "USER PIN ON" (User PIN enabled) appears for 2 seconds.

**Result**

The User PIN is activated after about 10 minutes or after a device restart.



**7.4.4 Enabling button lock**

**Procedure**

1. Navigate into the parameter view.  
Navigating in the views (Page 77)
2. In the parameter view, select the "Button lock" parameter.
3. Press the ► button.  
The "EDIT" symbol flashes.
4. Select ON with the ▲ or ▼ button.



5. Use the ► button to confirm.

**Result**

- The display automatically returns to the measurement view.
- The display automatically changes between the measured values every 12 seconds.
- The symbol for button lock "LL" and the measured value ID are displayed alternately.

---

**Note**

For a device without display, you activate the button lock using remote operation.

---





# Commissioning

## 8.1 Basic safety instructions

### DANGER

#### Toxic gases and liquids

Danger of poisoning when venting the device: if toxic process media are measured, toxic gases and liquids can be released.

- Before venting ensure that there are no toxic gases or liquids in the device, or take the appropriate safety measures.

### WARNING

#### Improper commissioning in hazardous areas

Device failure or risk of explosion in hazardous areas.

- Do not commission the device until it has been mounted completely and connected in accordance with the information in Technical data (Page 211).
- Before commissioning take the effect on other devices in the system into account.

### WARNING

#### Commissioning and operation with pending error

If an error message appears, correct operation in the process is no longer guaranteed.

- Check the gravity of the error.
- Correct the error.
- If the error still exists:
  - Take the device out of operation.
  - Prevent renewed commissioning.

### WARNING

#### Loss of explosion protection

Risk of explosion in hazardous areas if the device is open or not properly closed.

- Close the device as described in Connecting (Page 67).

 <b>WARNING</b>
<b>Opening device in energized state</b> Risk of explosion in hazardous areas <ul style="list-style-type: none"><li>• Only open the device in a de-energized state.</li><li>• Check prior to commissioning that the cover, cover locks, and cable inlets are assembled in accordance with the directives.</li></ul> <b>Exception:</b> Devices having the type of protection "Intrinsic safety Ex i" may also be opened in energized state in hazardous areas.

---

**Note**

**Hot surfaces**

Hot process medium and high ambient temperatures lead to hot surfaces which can cause burns.

- Take corresponding protective measures, for example wear protective gloves.

---

 <b>WARNING</b>
<b>Hazardous contact voltage</b> Risk of injury through hazardous contact voltage when the device is open or not completely closed.  The degree of protection specified on the nameplate or in Technical data (Page 211) is no longer guaranteed if the device is open or not properly closed. <ul style="list-style-type: none"><li>• Make sure that the device is securely closed.</li></ul>

## 8.2 Commissioning the device without display

### Introduction

In this section, you will learn how to commission the device step-by-step.

Before you start, please read the following safety notes:

- General safety notes (Page 19)
- Basic safety notes: Installing/mounting (Page 43)
- Basic safety notes: Connecting (Page 67)
- Basic safety notes: Commissioning (Page 89)

Read the entire device manual in order to achieve the optimum performance of the device.

## Procedure

1. Mount the device.  
Installation (except level) (Page 47)  
Installation (level) (Page 51)
2. Connect the device.  
Connecting the device (Page 70)
3. Switch on the supply voltage.  
Switching on the supply voltage (Page 76)
4. Open the cover of the buttons:

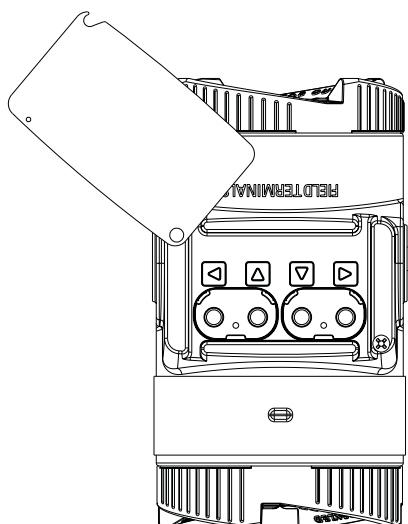

Figure 8-1 Top view

5. Operate the buttons as follows:

Apply lower range value (with pressure applied)	Hold down the button ▼ for 3 seconds.
Apply upper range value (with pressure applied)	Hold down the button ▲ for 3 seconds.
Zero point adjustment	Hold down the buttons ▲ and ▼ for 3 seconds.
Set Upper fault current	Hold down the button ◀ for 3 seconds.
Set Lower fault current	Hold down the button ▶ for 3 seconds.

Further functions are available via remote operation (e.g. SIMATIC PDM).

## See also

Diagnostic messages (Page 202)

## 8.3 Commissioning the device with display

### Introduction

In this section, you will learn how to commission the device step-by-step.

Before you start, please read the following safety information:

- General safety information (Page 19)
- Basic safety information: Installing/mounting (Page 43)
- Basic safety information: Connecting (Page 67)
- Basic safety information: Commissioning (Page 89)

Read the entire device manual in order to achieve the optimum performance of the device.

**Procedure**

1. Mount the device.  
Installation (except level) (Page 47)  
Installation (level) (Page 51)
2. Connect the device.  
Connecting the device (Page 70)
3. Switch on the supply voltage.  
Switching on the supply voltage (Page 76)
4. Open the cover of the buttons:

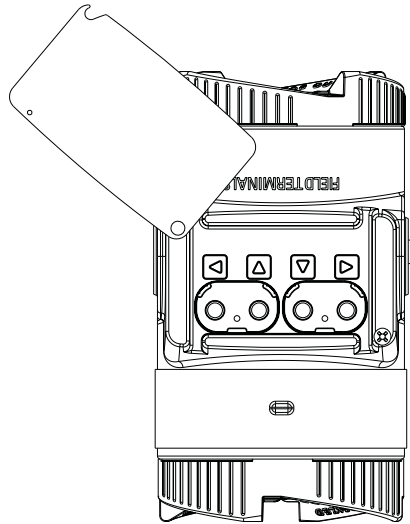

Figure 8-2 Top view

5. Set the measuring range.  
Set lower range value/upper range value (without pressure available) (Page 111)  
Apply lower range value/upper range value (with pressure present) (Page 124)
6. Set the pressure unit.  
Setting the pressure units (Page 109)
7. Set the application of your device.  
Set application (Page 113)
8. Set the scaling points.  
Set lower scaling point (Page 133)  
Set upper scaling point (Page 134)

9. Set the zero point.
    - Adjusting zero point (gauge pressure) (Page 122)
    - Adjusting the zero point (differential pressure) (Page 123)
    - Adjusting zero point (absolute pressure) (Page 123)
  10. Lock the device.
    - Locking the device (Page 84)
  11. Enable Functional Safety (for devices with Functional Safety).
    - Enabling Functional Safety over device with display (Page 171)
- You can find additional functions in the section Parameter assignment (Page 103)

**See also**

Diagnostic messages (Page 202)

## **8.4 Application examples**

### **8.4.1 Gauge pressure, absolute pressure from differential pressure series, and absolute pressure from gauge pressure series**

#### **8.4.1.1 Commissioning in gaseous environments**

**Requirement**

All valves are closed.

Procedure

A

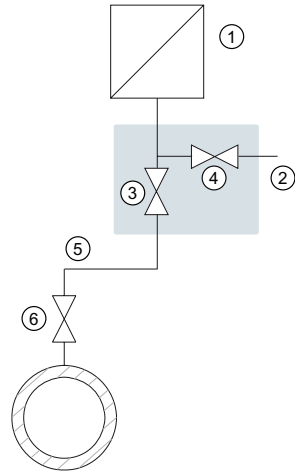

B

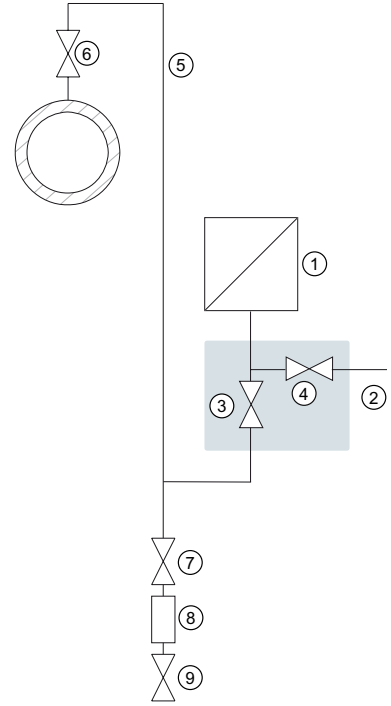

A Pressure transmitter above the pressure sampling point

- ① Pressure transmitter
- ② Shut-off valve
- ③ Shut-off valve to process
- ④ Shut-off valve for test connection or for bleed screw
- ⑤ Pressure line

B Pressure transmitter below the pressure sampling point

- ⑥ Shut-off valve
- ⑦ Shut-off valve (optional)
- ⑧ Condensate vessel (optional)
- ⑨ Blowout valve

1. Open the shut-off valve for the test connection ④.
2. Via the test connection of the shutoff valve ②, apply the pressure corresponding to the lower range value to the pressure transmitter.
3. Ensure that the lower range value corresponds to the desired value. Otherwise, correct the value.
4. Close the shut-off valve for the test connection ④.
5. Open the shut-off valve ⑥ at the pressure tapping point.
6. Open the shut-off valve for the process ③.

### 8.4.1.2 Commissioning with steam or liquid

#### Requirement

All valves are closed.

#### Procedure

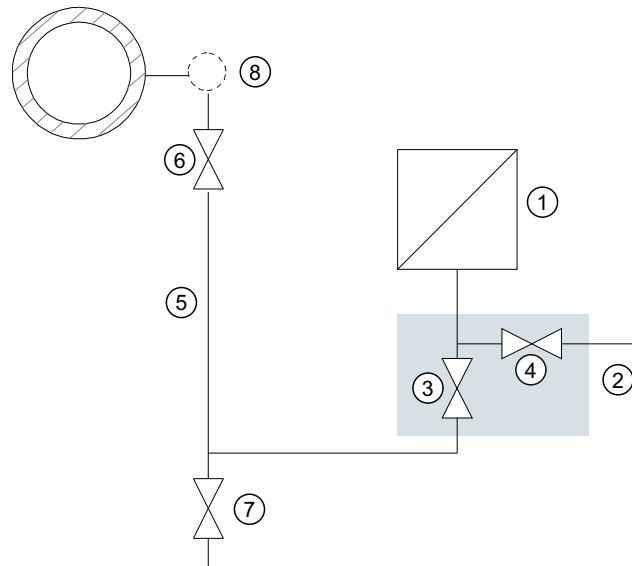

- ① Pressure transmitter
- ② Shut-off valve
- ③ Shut-off valve to process
- ④ Shut-off valve for test connection or for bleed screw
- ⑤ Pressure line
- ⑥ Shut-off valve
- ⑦ Drain valve
- ⑧ Compensation vessel (steam only)

1. Open the shut-off valve for the test connection ④.
2. Via the test connection of the shutoff valve ②, apply the pressure corresponding to the lower range value to the pressure transmitter.
3. Ensure that the lower range value corresponds to the desired value. Otherwise, correct the value.
4. Close the shut-off valve for the test connection ④.
5. Open the shut-off valve ⑥ at the pressure tapping point.
6. Open the shut-off valve for the process ③.

### 8.4.2 Differential pressure and flow rate

#### 8.4.2.1 Commissioning in gaseous environments

##### Requirement

All shut-off valves are closed.

##### Procedure

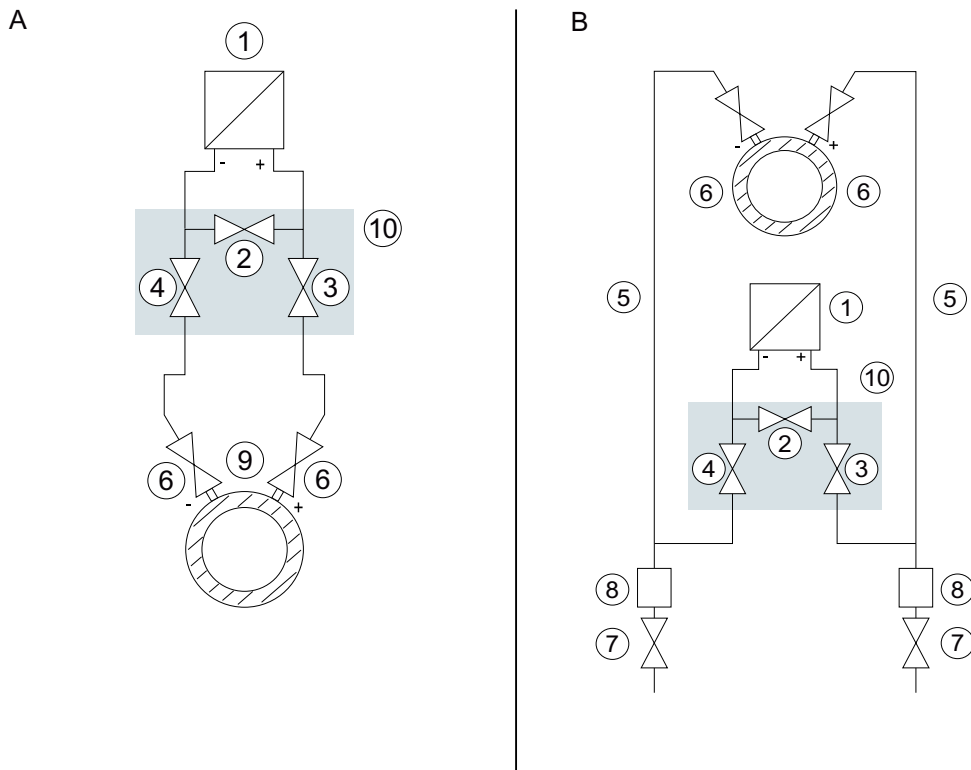

- A Pressure transmitter above the differential pressure transducer
- ① Pressure transmitter
  - ② Stabilizing valve
  - ③, ④ Differential pressure valves
  - ⑤ Differential pressure lines
  - ⑥ Shut-off valves

- B Pressure transmitter below the differential pressure transducer
- ⑦ Blowout valves
  - ⑧ Condensate vessels (optional)
  - ⑨ Differential pressure transducer (e.g. FPS200 and FPS300)
  - ⑩ 3-way valve manifold

1. Open both the shut-off valves ⑥ at the pressure tapping point.
2. Open the stabilizing valve ②.
3. Open the differential pressure valve (③ or ④).
4. Check and, if necessary, correct the zero point when the lower range value is 0 bar (4 mA).



5. Close the stabilizing valve ②.
6. Open the other differential pressure valve (③ or ④).

### 8.4.2.2 Commissioning for liquids

#### Requirement

All valves are closed.

 <b>DANGER</b>	
<b>Toxic liquids</b>	
Danger of poisoning when the device is vented.	
If toxic process media are measured with this device, toxic liquids can escape when the device is vented.	
<ul style="list-style-type: none"><li>• Before venting, make sure there is no liquid in the device or take the necessary safety precautions.</li></ul>	

Procedure

A

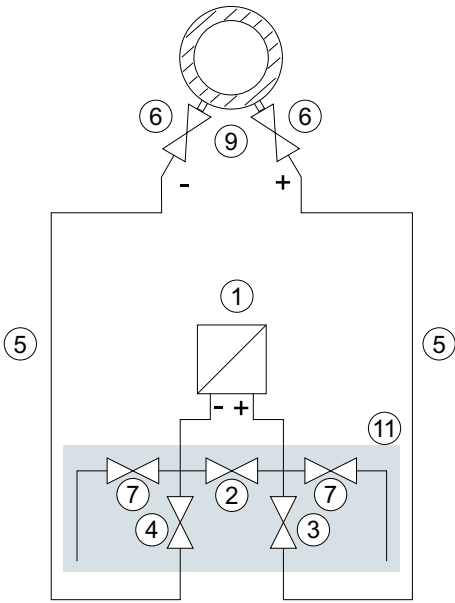

B

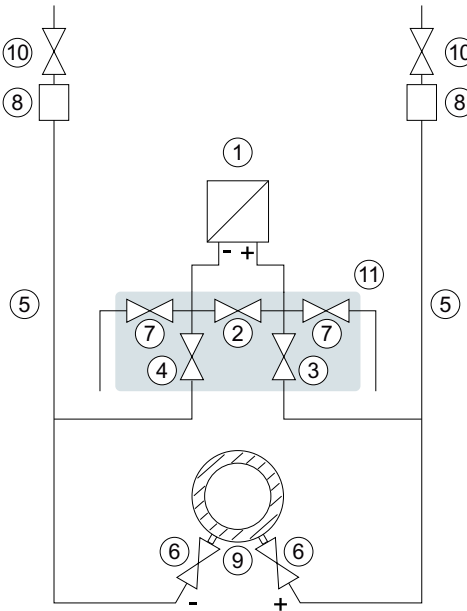

A Pressure transmitter below the differential pressure transducer

- ① Pressure transmitter
- ② Stabilizing valve
- ③, ④ Differential pressure valves
- ⑤ Differential pressure lines
- ⑥ Shut-off valves

B Pressure transmitter above the differential pressure transducer

- ⑦ Drain valves
- ⑧ Gas collector vessels (optional)
- ⑨ Differential pressure transducer
- ⑩ Vent valves
- ⑪ 5-way valve manifold

1. Open both the shut-off valves ⑥ at the pressure tapping point.
2. Open the stabilizing valve ②.
3. With **pressure transmitters below the differential pressure transducer**, partially open both drain valves ⑦ one after the other until liquid emerges without bubbles.  
In the case of a **pressure transmitter above the differential pressure transducer**, partially open both vent valves ⑩ one after the other until liquid emerges without bubbles.
4. Close both drain valves ⑦ or vent valves ⑩.
5. Partially open the differential pressure valve ③ and the vent valve (sealing plug with vent valve) on the positive side of the pressure transmitter until liquid escapes without bubbles.
6. Close the vent valve (sealing plug with vent valve).
7. Partially open the vent valve (sealing plug with vent valve) on the negative side of the pressure transmitter until liquid escapes without bubbles.
8. Close the differential pressure valve ③.

9. Partially open the differential pressure valve ④ until liquid escapes without bubbles.
10. Close the differential pressure valve.
11. Close the vent valve (sealing plug with vent valve) on the negative side of the pressure transmitter.
12. Open the differential pressure valve ③ with half a revolution.
13. For a lower range value of 0 bar, check the zero point (4 mA) and correct the lower range value if it is different.
14. Close the stabilizing valve ②.
15. Open the differential pressure valves (③ and ④) completely.

### 8.4.2.3 Commissioning with vapor

#### Requirement

All valves are closed.

<p> <b>WARNING</b></p> <p><b>Hot vapor</b></p> <p>Danger of injury or damage to device.</p> <p>If the shut-off valves ⑥ and the differential pressure valve ③ are both open and the stabilizing valve ② is then opened, the pressure transmitter ① can be damaged by the flow of vapor.</p> <ul style="list-style-type: none"> <li>• Follow the specified procedure for commissioning.</li> </ul>
--

<p> <b>WARNING</b></p> <p><b>Hot vapor</b></p> <p>Danger of injury.</p> <p>You can briefly open the drain valves ⑦ to clean the line. Hot vapor can escape in the process.</p> <ul style="list-style-type: none"> <li>• Only open the drain valves ⑦ briefly, and close them again before vapor escapes.</li> </ul>
--

Procedure

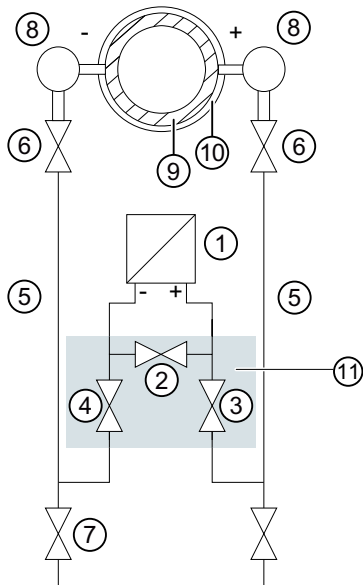

- |    |                              |   |                                  |
|----|------------------------------|---|----------------------------------|
| ①  | Pressure transmitter         | ⑦ | Drain valves                     |
| ②  | Stabilizing valve            | ⑧ | Condensate pots                  |
| ③, | Differential pressure valves | ⑨ | Differential pressure transducer |
| ④  |                              | ⑩ | Insulation                       |
| ⑤  | Differential pressure lines  | ⑪ | 3-way valve manifold             |
| ⑥  | Shut-off valves              |   |                                  |

1. Open both the shut-off valves ⑥ at the pressure tapping point.
2. Open the stabilizing valve ②.
3. Wait until the steam in the differential pressure lines ⑤ and in the equalizing vessels ⑧ has condensed.
4. Partially open the differential pressure valve ③ and the vent valve (sealing plug with vent valve) on the positive side of the pressure transmitter until condensate escapes without bubbles.
5. Close the vent valve (sealing plug with vent valve).
6. Partially open the vent valve (sealing plug with vent valve) on the negative side of the pressure transmitter until condensate escapes without bubbles.
7. Close the differential pressure valve ③.
8. Partially open the differential pressure valve ④ until condensate escapes without bubbles.
9. Close the vent valve with blanking plug on the negative side ①.
10. Close the differential pressure valve.
11. Open the differential pressure valve ③ by half a revolution.

12. For the lower range value 0 bar, check the zero point (4 mA).  
If the differential pressure lines ⑤ have equally high condensate columns with the same temperature, the measurement result is error-free. Otherwise, repeat the zero-point adjustment.
13. Close the stabilizing valve ②.
14. Fully open the differential pressure valves ③ and ④.

**Cleaning process cable**

1. To clean the line, briefly open the drain valves ⑦.
2. Close the drain valve ⑦ before vapor escapes.



# Parameter assignment

## 9.1 Overview of parameters and functions

### Introduction

You can operate the device via local operation or remote operation (e.g. SIMATIC PDM).

- The parameters that you can reach over the device with a display are marked by the parameter ID. Hereinafter, the parameter ID is always written inside parentheses after the parameter name. Example: Parameter "Damping value" [04].
- You can access the complete number of parameters via remote operation. The device-specific parameters are available in each tool for configuration. The instructions or online help for these tools will provide you with information on how to use the different tools for parameter assignment.

### List of parameters and functions

The following parameters are available via the local operation and via remote operation (e.g. SIMATIC PDM).

The parameters are grouped according to their function in the following overview:

Quick start	SIMATIC PDM	Device with display (local operation)	Device without display (local operation)
Quick start wizard	Menu command "Device > Wizard - Quick start..."	-	-

Current output	SIMATIC PDM	Device with display (local operation)	Device without display (local operation)
Apply lower range value (with pressure applied) Apply upper range value (with pressure applied)	Menu command "Device > Apply values"	Zero point adjustment [07] (Page 122) Apply upper range value parameter [09] (Page 124)	Commissioning the device without display (Page 11)
Set lower range value (without pressure applied) Set upper range value (without pressure applied)	"Settings > Current output" parameter group	Set lower range value parameter [02] (Page 110) Set upper range value parameter [03] (Page 110)	-
Set damping value	"Settings > Current output" parameter group	Damping value [04] (Page 112)	-

9.1 Overview of parameters and functions

Current output	SIMATIC PDM	Device with display (local operation)	Device without display (local operation)
Set fault current	"Settings > Current output" parameter group	Select fault current [10] (Page 126) Lower fault current [11] (Page 126) Upper fault current [12] (Page 127)	Commissioning the device without display (Page 11)
Set saturation limits	"Settings > Current output" parameter group	Lower saturation limit [13] (Page 127)/Upper saturation limit [14] (Page 128)	-
Digital-to-analog converter trim	Menu command "Device > DAC trim"	-	-
Loop test	Menu command "Device > Loop test"	Loop test [31] (Page 143)	-

Application	SIMATIC PDM	Device with display (local operation)	Device without display (local operation)
Select pressure units	"Settings > Sensor > Units" parameter group	Display of the pressure units (Page 109)	-
Select the temperature unit for sensor and electronics temperature	"Settings > Sensor temperature unit" parameter group	Temperature units [17] (Page 132)	-
Set additional measuring task (e.g. level, volume flow, mass flow, volume, set customized characteristic curve)	"Settings > Select output > Application" parameter group	Set application (Page 113)	-
Set customized characteristic curve	Menu command "Device > Customized characteristic curve"	-	-
Set scaling points	"Settings > Current output > Scaling"	Lower scaling point [18] (Page 132)/Upper scaling point [19] (Page 133)	-
Select unit of scaled value	"Settings > Current output > Scaling > Units"	Units [16] (Page 129)	-



Calibration	SIMATIC PDM	Device with display (local operation)	Device without display (local operation)
Correct the zero point error	Menu command "Device > Zero point adjustment"	Zero point adjustment [07] (Page 122)	Commissioning the device without display (Page 11)
Sensor calibration	Menu command "Device > Sensor calibration"	-	-
Apply lower range value Apply upper range value	Menu command "Device > Apply values"	Apply lower range value parameter [08] (Page 124) Apply upper range value parameter [09] (Page 124)	Commissioning the device without display (Page 11)

Simulation	SIMATIC PDM	Device with display (local operation)	Device without display (local operation)
Fixed pressure value or ramp	Menu command "Device > Simulation > Process values"	-	-

Identification	SIMATIC PDM	Device with display (local operation)	Device without display (local operation)
Read and configure identification data of your device	"Identification" parameter group	-	-

Maintenance and diagnostics	SIMATIC PDM	Device with display (local operation)	Device without display (local operation)
Read diagnostic log	Menu command "Device > Diagnostic log"	-	-
Display of the diagnostics	Menu command "Diagnostics > Diagnostics"	Diagnostics and troubleshooting (Page 199)	-
Simulate diagnostics	Menu command "Device > Simulation > Diagnostics"	-	-
Limit monitoring and event counter	Menu command "Device > Limit monitoring and event counter"	-	-
Device maintenance, sensor maintenance, service, calibration	Menu command "Maintenance"	-	-
Display operating time Operating hours counter (Page 161)	Menu command "Diagnostics > Device status > HART status"	-	-

9.1 Overview of parameters and functions

Maintenance and diagnostics	SIMATIC PDM	Device with display (local operation)	Device without display (local operation)
Set peak values Reset peak values	"Maintenance and diagnostics > Peak values" parameter group Menu command "Device > Reset peak values"	-	-
Configure trend log Show trend log	Menu command "Device > Trend log settings" Menu command "Diagnostics > Trend log"	-	-
Display number of measuring cells or measuring transducer electronics replacement	Parameter group "Maintenance and diagnostics > Audit trail > HW exchange counter"	-	-

HART communication	SIMATIC PDM	Device with display (local operation)	Device without display (local operation)
Configure HART address	Menu command "Device > Assign address"	-	-
Set the loop current value in multidrop mode	"Settings > Current output > Loop current value in multidrop mode"	-	-
Enable or disable the device identification via HART command "Find device"	-	Identify the device [34] (Page 145)	-
Select secondary variable (SV)	"Settings > Select output > SV selection" parameter group	SV selection [15] (Page 129)	-
Select tertiary variable (TV)	"Settings > Select output > TV selection" parameter group	-	-
Select quaternary variable (QV)	"Settings > Select output > QV selection" parameter group	-	-

Write protection	SIMATIC PDM	Device with display (local operation)	Device without display (local operation)
Enable and disable user PIN	Menu command "Device > Security"	User PIN [27] (Page 140)	-
Change user PIN	Menu command "Device > Security > Change user PIN"	Change user PIN [24] (Page 137)	-
Display Recovery ID	Menu command "Device > Security > PIN recovery"	Recovery ID [25] (Page 138)	-

<b>Write protection</b>	<b>SIMATIC PDM</b>	<b>Device with display (local operation)</b>	<b>Device without display (local operation)</b>
Restore user PIN	Menu command "Device > Security > PIN recovery"	PIN recovery [26] (Page 139)	-
Enable and disable button lock	"Security > Button lock" parameter group	Button lock [23] (Page 136)	-

<b>Display</b>	<b>SIMATIC PDM</b>	<b>Device with display (local operation)</b>	<b>Device without display (local operation)</b>
Set pressure reference (absolute, gauge)	"Display > Pressure reference" parameter group	Pressure reference [33] (Page 145)	-
Set start view	"Display > Start view" parameter group	Start view [32] (Page 144)	-
Display test	Menu command "Device > Squawk"	Display test [30] (Page 142)	-

<b>Reset</b>	<b>SIMATIC PDM</b>	<b>Device with display (local operation)</b>	<b>Device without display (local operation)</b>
Device restart	Menu command "Device > Device restart"	-	-
Reset digital-to-analog converter to factory setting	Menu command "Device > Reset > Restore to factory DAC calibration"	Reset DAC trim to the factory setting (Page 146)	-
Restore ordered configuration	Menu command "Device > Reset > Restore ordered configuration"	Restore ordered configuration (Page 147)	-
Factory reset	Menu command "Device > Reset > Factory reset"	Restore factory settings (Page 147)	-
Reset to sensor calibration	Menu command "Device > Reset > Reset to sensor calibration"	Reset to sensor calibration (Page 146)	-

## Functional Safety

The following additional functionality is available for devices with Functional Safety:

Functional Safety	SIMATIC PDM	Device with display (local operation)	Device without display (local operation)
Enable and disable Functional Safety	Menu command "Device > Functional Safety"	Functional Safety [29] (Page 142)	-
Set the overload behavior	"Setup > Functional Safety > Overload behavior" parameter group	Overload behavior [36] (Page 147)	-

## 9.2 Parameter assignment over device with display

### Introduction

This section describes all parameters that you can reach over the device with a display.

You will find information on operating the device with display in the section Operating the device with display (Page 77).

You can find the list of available parameters with ID and parameter name in the section List of parameters on the display (Page 80).

### 9.2.1 Pressure units [01]

With the "Pressure units" [01] parameter, you select the unit of the "Pressure" (P1) measured value that is displayed in the measurement view.

You can find a description of the pressure units that you can set in the section Display of the pressure units (Page 109).

With the "Pressure reference" parameter [33], you adapt the display of the pressure units to your application, if necessary (absolute pressure or gauge pressure).

Both parameters are available using a local operation or over the remote operation.

### Example

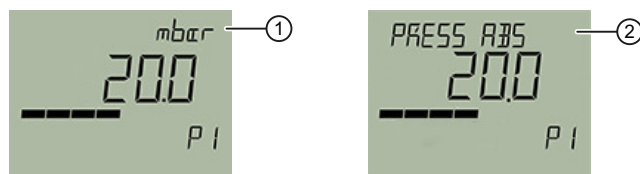

Pressure units ① and Pressure reference ② (alternating)

**See also**

Pressure reference [33] (Page 145)

**9.2.1.1 Display of the pressure units**

Certain units are displayed differently on the display and over remote operation.

**Example: Display of unit "mmH<sub>2</sub>O" on the display**



Unit ① in the title bar









Unit ② as enumeration

Setting range:	Display (header line)	Display (enumeration)	Remote operation
	mbar	mbar	mbar
	bar	bar	bar
	Pa	Pa	Pa
	KPa	KPa	KPa
	MPa	MPa	MPa
	PSI	PSI	psi
	G/cm2	G/cm2	g/cm <sup>2</sup>
	KG/cm2	KG/c2	kg/cm <sup>2</sup>
	KGf/cm2	KF/c2	kgf/cm <sup>2</sup>
	mmH2O	mmW68	mmH <sub>2</sub> O
	mH2O (4 °C)	mmW4	mH <sub>2</sub> O (4 °C)
	inH2O (68 °F)	inW68	inH <sub>2</sub> O (68 °F)
	inH2O (4 °C)	inW4	inH <sub>2</sub> O (4 °C)
	mmHG	mmHG	mmHg
	inHG	inHG	inHg
	hPa	hPa	hPa
	atm	atm	atm
	torr	torr	torr
Factory setting:	Depending on the measuring cell, mbar or bar, or as specified in the order		

**9.2.1.2 Setting the pressure units****Requirement**

You know the parameter values for the "Pressure units" parameter. (Page 109)

**Procedure**

1. Navigate to the parameter view.  
Navigating in the views (Page 77)
2. Select the "Pressure units" parameter [01].
3. Press the  button.
4. Select the desired unit with the  or  button.  
The pressure measurement is converted to the new pressure unit.
5. Use the  button to confirm.
6. Navigate to the "Pressure reference" parameter [33].
7. Press the  button.
8. Select the specific pressure unit for your application (absolute pressure, gauge pressure, none) with the  or  button.

**Result**

- The selected pressure unit and pressure reference are displayed as alternating values in the measurement view.
- If the converted pressure measurement has more than 5 digits, "#####" appears in the measurement view: Adjust the unit so that a lower value is displayed, e.g. bar instead of mbar.

**9.2.2 Set lower range value [02]/Set upper range value [03]**

**9.2.2.1 Set lower range value parameter [02]**

Sets the lower range value without applied pressure.

Setting range:	Within the measuring limits
Factory setting:	0 bar, or as specified in order

**9.2.2.2 Set upper range value parameter [03]**

Sets the upper range value without applied pressure.

Setting range:	Within the measuring limits
Factory setting:	Upper measuring range limit, or as specified in order

### 9.2.2.3 Set lower range value/upper range value (without pressure available)

#### Introduction

The lower range value (4 mA) corresponds to 0% of the measuring range. The upper range value (20 mA) corresponds to 100% of the measuring range.

Without pressure available, you have the following options for assigning the desired pressure measurements to the lower range value and the upper range value:









	Device without display	Device with display	Remote operation
Set lower range value	-	"Lower range value" parameter [02]	Settings > Current output > Lower range value
Set upper range value	-	"Upper range value" parameter [03]	Settings > Current output > Upper range value

The minimum permissible measuring span of the measuring cell must not be fallen below. You can find the minimum permissible measuring span of your measuring cell in the section Technical data (Page 211)

#### Requirement

- No pressure is present.
- You have a device with display.

#### Procedure

1. Navigate to the parameter view.  
Navigating in the views (Page 77)
2. In the parameter view, set the "Lower range value" parameter [02].
3. Press the  button.
4. Enter a value within the measuring limits with the  and  buttons.
5. Use the  button to confirm.  
The lower range value is set. Note that the upper range value does not move automatically.
6. Navigate to the "Set upper range value" parameter [03].
7. Press the  button.
8. Enter a value within the measuring limits with the  and  buttons.
9. Use the  button to confirm.  
The upper range value is set.

#### Result

You have set your measuring range.

- If the minimum permissible measuring span is fallen below, the message "FAILED" appears.

### 9.2.3 Damping value [04]

Sets the damping (filtering) for smoothing of sudden process value variations.

Setting range:	0.01 s ... 100 s in increments of 0.01 s
Factory setting:	2 s, or as specified in order

The damping influences the response time of the device: When you increase the damping value, the response time of the pressure transmitter to changes in the pressure measurement increases.

- Reduce the damping value for faster response times. Specify a value that meets the requirements regarding signal stability and response time.

#### 9.2.3.1 Set damping value

##### Procedure

1. Navigate to the parameter view.  
Navigating in the views (Page 77)
2. Select the "Damping value" parameter.
3. Press the ► button.
4. Set the damping with the ▲ and ▼ buttons.
5. To set the damping in steps of 0.10 s, press and hold down the buttons.
6. Use the ► button to confirm.

### 9.2.4 Application [05]

#### 9.2.4.1 Introduction

You use the "Application" parameter to adjust the device for the following measuring tasks.

- Pressure measurement
- Level measurement
- Volume flow measurement
- Mass flow measurement
- Volume measurement
- Customized characteristic curve (only available via remote operation). (Page 152)

##### Characteristic curves

The device uses a linear characteristic curve for pressure and level measurements.

For volume and mass flow measurements, the device uses adjustable square root functions.



For volume measurement, the device uses the tank characteristic curves for various vessel geometries.

In the "Customized characteristic curve" application, enter the breakpoints of the characteristic curve using remote operation (e.g. SIMATIC PDM).

The set application acts directly on the current output:

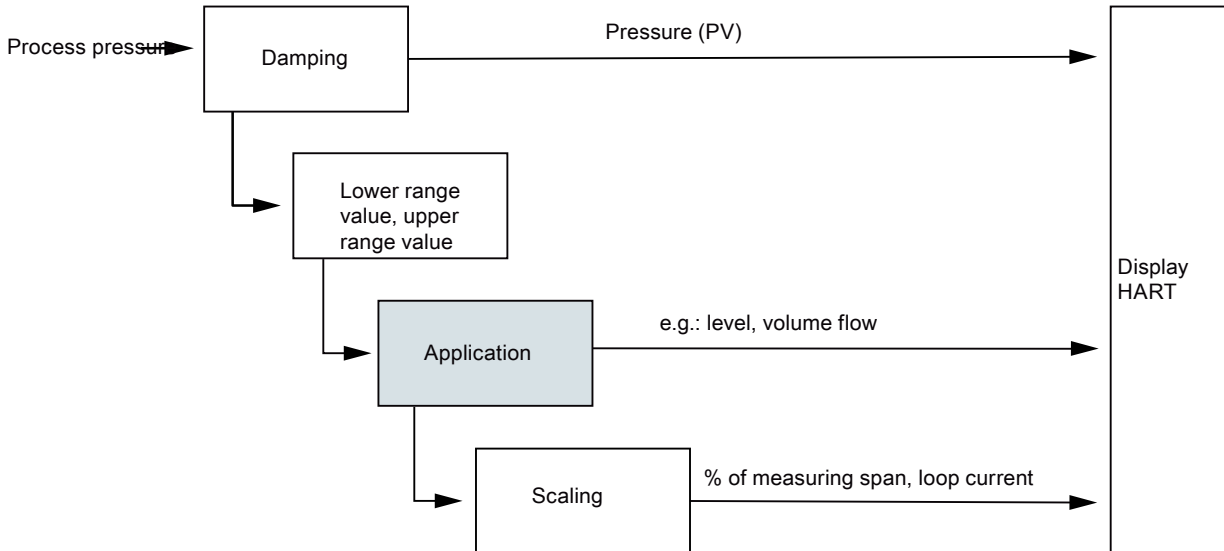

Figure 9-1 Flow diagram

You have various options for setting the measuring task of your device:

Device with display	Remote operation
"Application" parameter [05]	Settings > Select output > Application or using the Quick start wizard

### 9.2.4.2 Set application

#### Procedure

1. Navigate to the parameter view.  
Navigating in the views (Page 77)
2. Select the "Application" parameter [05].
3. Select the parameter value.  
Set application (Page 113)

Setting range:	Application	Characteristic curve	
	Pressure	PRESS	Linear, proportional to pressure
	Level	LEVEL	Linear, proportional to level
	Volume flow	VSLN	Linear, square root Proportional to flow rate, linear up to the application point (Page 121)
		VSOFF	Hold at 0, square root Proportional to flow rate, deactivated up to the suppression of the residual flow (Page 134)
		VSLN2	Two-step linear - square root Proportional to flow, two-step linear up to the application point
		VSL2B	Two-step linear, square root (bidirectional)
	Volume	CYLIN	Cylinder vessel
		SPHER	Sphere vessel
		VLIN	Linear vessel
		CONIC	Conical bottom vessel
		PARAB	Parabolic bottom vessel
		HALF	Half sphere bottom vessel
		FLAT	Flat sloped bottom vessel
	Mass flow	PARAE	Parabolic ends vessel
		MSLN	Linear, square root Proportional to flow rate, linear up to the application point (Page 121)
		MSOFF	Hold at 0, square root Proportional to flow rate, deactivated up to the suppression of the residual flow (Page 134)
		MSLN2	Two step linear, square root Proportional to flow, two-step linear up to the application point
	Customized characteristic curve	MSL2B	Two-step linear, square root (bidirectional)
		CUSTM	Custom
	Factory setting:	PRESS, or as specified in order	

### 9.2.4.3 Pressure measurement

To set the application of the device for the pressure measurement, select the "linear" characteristic curve using the "Application" parameter (PRESS).

- The device uses a linear characteristic curve:

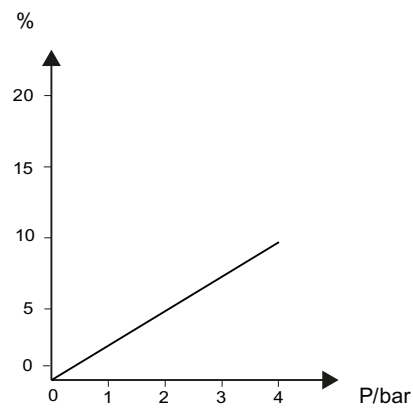

- If the device is set for pressure measurement, no other measured variables (e.g. volume flow) are available.

### Example

For the pressure measurement, you set the following values, for example:

Damping value:	2.0 s
Lower range value:	0.0 bar
Upper range value:	5.0 bar
Application:	Pressure: linear (PRESS)
Unit:	bar
Lower scaling point:	-
Upper scaling point:	-

#### 9.2.4.4 Level measurement

To set the application of the device for the level measurement, select the "level" characteristic curve using the "Application" parameter (LEVEL).

For a level measurement, the device calculates the level height and the hydrostatic pressure. The geometry of the vessel is not included in the calculation.

- The device uses a linear characteristic curve:

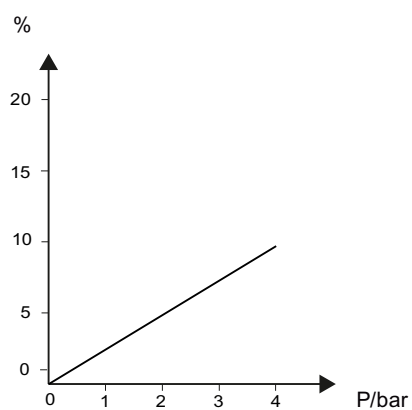

### Example

For the level measurement, you set the following values, for example:

Damping value:	2.0 s
Lower range value:	0.0 bar
Upper range value:	5.0 bar
Application:	Level (LEVEL)
Unit:	m
Lower scaling point:	0.0 m
Upper scaling point:	49 m

### 9.2.4.5 Volume and mass flow measurements

The following characteristic curves are available for volume and mass flow measurements:

- **Hold at 0, square root (VSOFF, for volume or MSOFF, for mass flow)**

The loop current is 4 mA up to the application point (**low flow cut-off** (Page 134)). Starting from the application point, scaling occurs according to the square root:

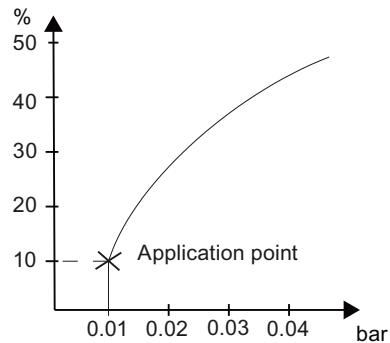

Y Loop current or flow

X Set measuring span

- **Linear, square root (VSLN, for volume or MSLN, for mass flow)**

The loop current has a linear relationship with the differential pressure up to the application point (Page 121). Starting from the application point, scaling occurs according to the square root:

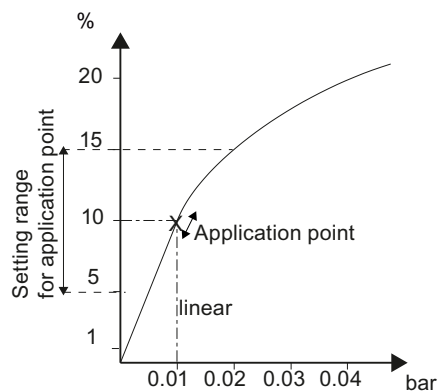

Y Loop current or flow

X Set measuring span

9.2 Parameter assignment over device with display

- **Two step linear, square root (VSLN2, for volume or MSLN2, for mass flow)**

The loop current has a proportional relationship with the flow rate, two step linear up to the application point (Page 121).

The square root SLIN2 has a permanently defined application point of 10%. The range up to this point contains two linear characteristic curve sections. The first section ranges from the zero point to 0.6% of the output value and 0.6% of the pressure value. The second section runs at a steeper slope up to the application point at 10% of the output value and 1% of the pressure value.

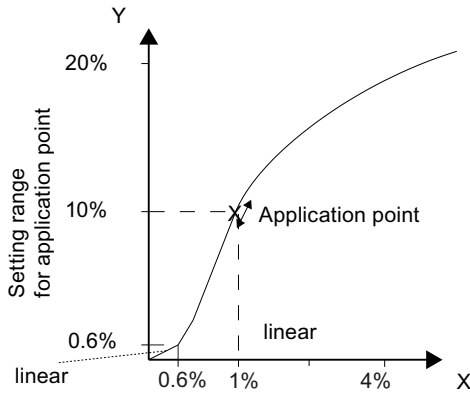

Y Loop current or flow

X Set measuring span

- **Two step linear, square root or bidirectional flow measurement (VSL2B, for volume or MSL2B for mass flow)**

For bidirectional flow measurement, enter symmetrical scaling values.

Select a lower scaling value that is symmetrical to the upper scaling value.

Example:

Upper scaling value: 1000 m<sup>3</sup>/s

Lower scaling value: -1000 m<sup>3</sup>/s

The output current in the range of 4 to 20 mA is halved in each case for the forward and reverse measurements.

- The output current of 4 to 12 mA is used for the reverse measurement.
- The output current of 12 to 20 mA is used for the forward measurement.

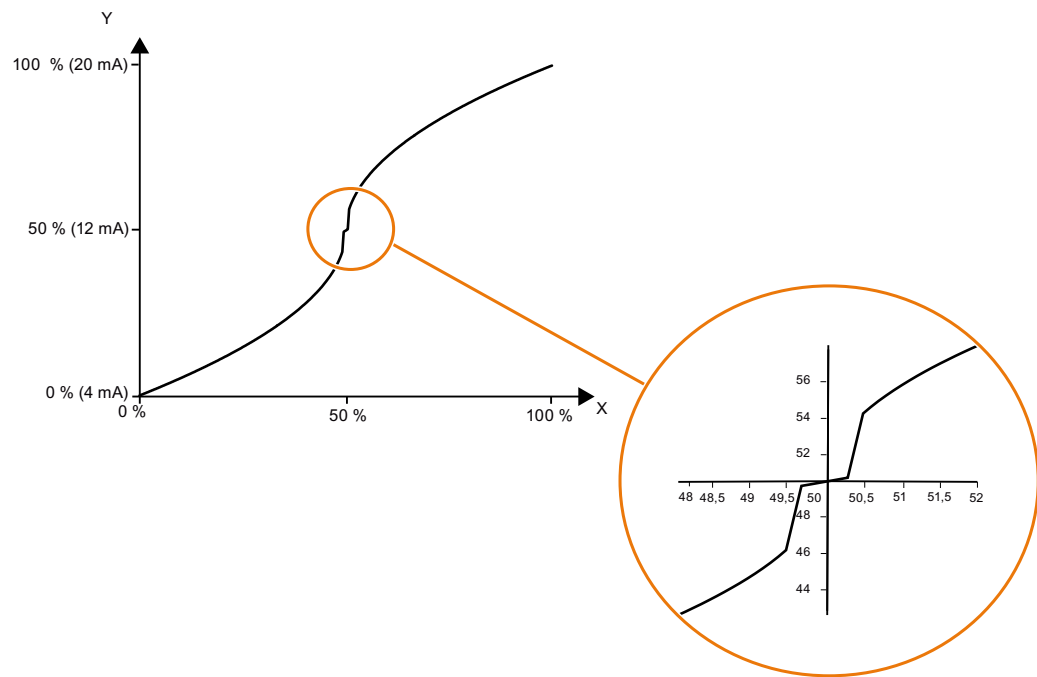

Y Loop current or flow  
X Set measuring span

### Example: Volume flow

For the volume flow measurement, you set the following values, for example:

Damping value:	2.0 s
Lower range value:	0.0 mbar
Upper range value:	0.6 bar
Application:	Linear, square root (VSLN)
Unit:	m <sup>3</sup> /h
Lower scaling point:	0.0 m <sup>3</sup> /h
Upper scaling point:	300 m <sup>3</sup> /h

### Example: Mass flow

For the mass flow measurement, you set the following values, for example:

Damping value:	1 s
Lower range value:	0.0 mbar
Upper range value:	600 mbar
Application:	Linear, square root (MSLN)
Unit:	t/h
Lower scaling point:	0.0 t/h
Upper scaling point:	300 t/h

9.2.4.6 Volume measurement

For the volume measurement, the device uses tank characteristic curves for various vessel shapes.

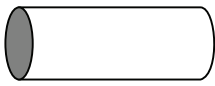
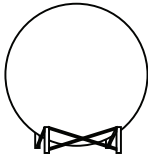
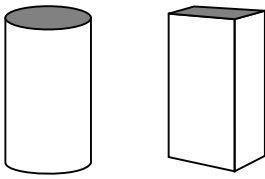
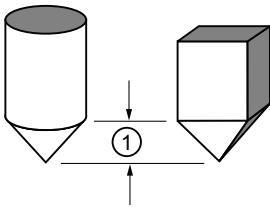
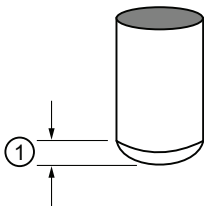
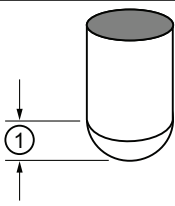
Display	Vessel	Description
CYLIN		Cylinder vessel
SPHER		Sphere vessel
LINR		Linear vessel
CONIC		Conical bottom vessel ①:Vessel dimension A
PARAB		Parabolic bottom vessel ①:Vessel dimension A
HALF		Half sphere bottom vessel ①:Vessel dimension A

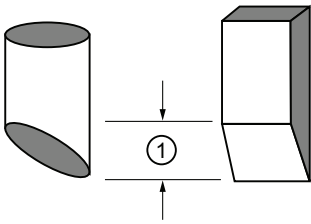
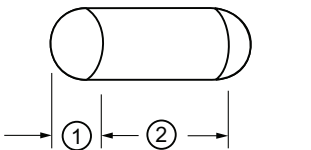

Display	Vessel	Description
FLAT		Flat sloped bottom vessel ①: Vessel dimension A
PARAE		Parabolic ends vessel ①: Vessel dimension A ②: Vessel dimension L

### Example

For the volume measurement, you set the following values, for example:

Damping value:	2.0 s
Lower range value:	0.0 mbar
Upper range value:	500.0 mbar
Application:	Cylinder vessel (CYLIN)
Unit:	m <sup>3</sup>
Lower scaling point:	0.0 m <sup>3</sup>
Upper scaling point:	10.0 m <sup>3</sup>

### 9.2.5 Application point [06]

Sets the application point from which scaling occurs according to the square root. Before the application point, the scaling occurs in a linear relationship with the differential pressure.

This parameter is only visible when you have selected the characteristic curve "Linear, square root" (VSLIN or MSLIN) using the "Application" parameter.

Setting range:	5 to 15%
Factory setting:	10%

### See also

Volume and mass flow measurements (Page 117)

## 9.2.6 Zero point adjustment [07]

### Introduction

A series of factors, such as installation, static pressure, temperature or long-term stability, can cause zero-point errors.

For special applications (e.g. level measurement for a closed vessel), you have the option of shifting the zero point to a desired pressure value using the "Zero point adjustment" parameter.

You proceed differently depending on the device version.

### 9.2.6.1 Adjusting zero point (gauge pressure)

#### Requirement

The pressure measurement is stable.

#### Procedure

1. Vent the pressure connection of the device.
2. Navigate to the parameter view.  
Navigating in the views (Page 77)
3. Select the "Zero point adjustment" parameter [07].
4. Press the ► button.  
The value "0" appears on the display and the "EDIT" symbol flashes.
5. Set the zero point to 0 or to the desired value.
6. Confirm the value by pressing the ► button.
7. Change to the measurement view with the ◀ button.

---

#### Note

Depending on the damping setting, a settling time elapses until the pressure measurement 0 appears in the measurement view.

- For this reason, vent the pressure connection of the device up to the end of the operation.
- 

#### Result

- The device displays the pressure measurement 0 in the set unit.
- The effective measuring range is reduced by the amount of the upstream pressure.  
Example: With an upstream pressure of 100 mbar, the effective measuring range of a 1-bar pressure transmitter is reduced to a point between 0 and 0.9 bar.

### 9.2.6.2 Adjusting the zero point (differential pressure)

#### Requirement

The pressure measurement is stable.

#### Procedure

1. Make sure there is identical pressure in the two process connections.
2. Navigate to the parameter view.  
Navigating in the views (Page 77)
3. In the parameter view, select the "Zero point adjustment" parameter [07].
4. Press the ► button.
5. Set the zero point to 0 or to the desired value.
6. Confirm the value by pressing the ► button.
7. Change to the measurement view with the ◀ button.

---

#### Note

Depending on the damping setting, a settling time elapses until the pressure measurement 0 is displayed.

- Make sure there is identical pressure in the two process connections until the end of the operation.
- 

#### Result

- The device displays pressure measurement 0 in the set unit.
- The effective measuring range is reduced by the amount of the upstream pressure.  
Example: At a pre-load pressure of 25 mbar, the upper measuring range limit of a 250 mbar pressure transmitter is reduced to 225 mbar.

### 9.2.6.3 Adjusting zero point (absolute pressure)

#### Requirement

You have created a reference pressure that is within the measurement limits.

#### Procedure

1. Navigate to the parameter view.  
Navigating in the views (Page 77)
2. Select the "Zero point adjustment" parameter [07].

3. Press the ► button.  
The value "0" appears on the display and the "EDIT" symbol flashes.
4. Enter the known reference pressure using the ▲ or ▼ buttons.
5. Confirm the value by pressing the ► button.
6. Change to the measurement view with the ◀ button.

## Result

The device displays pressure measurement 0 in the set unit.

Depending on the set damping, the settling time is extended until the pressure measurement 0 is displayed.

---

### Note

For devices for absolute pressure, the lower range value is at vacuum (0 bar a).

The zero point adjustment for devices for absolute pressure that do not measure absolute pressure (0 bar a) leads to incorrect settings.

---

## 9.2.7 Apply lower range value [08]/Apply upper range value [09]

### 9.2.7.1 Apply lower range value parameter [08]

Sets the lower range value to the current reference pressure.

Setting range:	Within the measuring limits
Factory setting:	See nameplate (depending on measuring cell)

### 9.2.7.2 Apply upper range value parameter [09]

Sets the upper range value to the current reference pressure.

Setting range:	Within the measuring limits
Factory setting:	See nameplate (depending on measuring cell)

### 9.2.7.3 Apply lower range value/upper range value (with pressure present)

## Introduction

The lower range value (4 mA) corresponds to 0% of the measuring range. The upper range value (20 mA) corresponds to 100% of the measuring range.

With pressure present, you have the following options for assigning the desired pressure measurements to the lower range value and the upper range value:

	Device without display	Device with display	Remote operation
Apply lower range value	Hold down the button ▲ for 3 seconds.	"Apply lower range value" parameter [08]	"Device > Apply values" menu
Apply upper range value	Hold down the button ▼ for 3 seconds.	"Apply upper range value" parameter [09]	"Device > Apply values" menu

The minimum permissible measuring span of the measuring cell must not be fallen below. You can find the minimum permissible measuring span of your measuring cell in the section Technical data (Page 211)

You can find an example below:

### Before You Start

- Your device has a display.
- A pressure is present, for example, the device is already installed.
- The pressure is within the measuring limits.
- Your device has a measuring cell, for example, from 0 to 16 bar:



### Procedure

1. Apply a pressure of 1 bar, for example.
2. Select the "Apply lower range value" parameter [08]. Press the ► button. The pressure is displayed.
3. Use the ► button to confirm. The wizard ends with the "COMPL" message (completed). For the measuring span to stay constant, the upper range value shifts from 16 bar to 17 bar.



4. Apply a pressure of 15 bar, for example.
5. Select the "Apply upper range value" parameter [09].

9.2 Parameter assignment over device with display

6. Press the ► button.  
The pressure is displayed.
7. Use the ► button to confirm.  
The wizard ends with the "COMPL" message (completed).  
The measuring span is now 14 bar.



**Note**

The wizard ends with the "FAILED" (failed) message in the following cases:

- The pressure exceeds or falls below the measuring limits.
- The measuring span is below the minimum permissible span.

**9.2.8 Select fault current [10]**

Selects whether the lower or upper fault current is output when a fault occurs (e.g. hardware/ firmware error, sensor break).

Setting range:	UPPER	Upper fault current
	LOWER	Lower fault current
Factory setting:	LOWER , or as specified in order	

**Devices with functional safety**

When a safety-related error is detected in the device in "Functional Safety enabled" device mode, the current output signal corresponds to the lower fault current  $\leq 3.55$  mA.

**9.2.9 Lower fault current [11]**

Adjusts the magnitude of the lower fault current ②.

Setting range:	Between 3.55 mA and lower saturation limit ③
Factory setting:	3.55 mA, or as specified in order

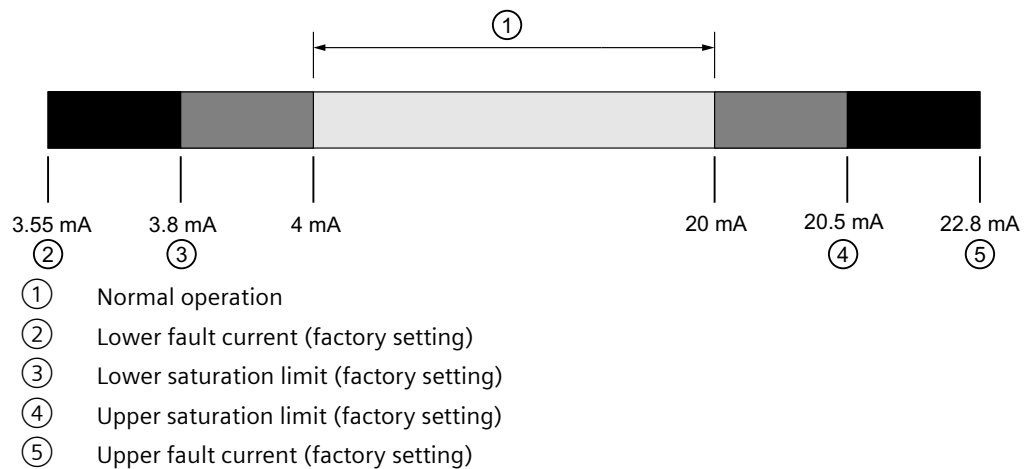

### 9.2.10 Upper fault current [12]

Adjusts the magnitude of the upper fault current ⑤.

Setting range:	Between upper saturation limit ④ und 22.8 mA
Factory setting:	22.8 mA, or as specified in order

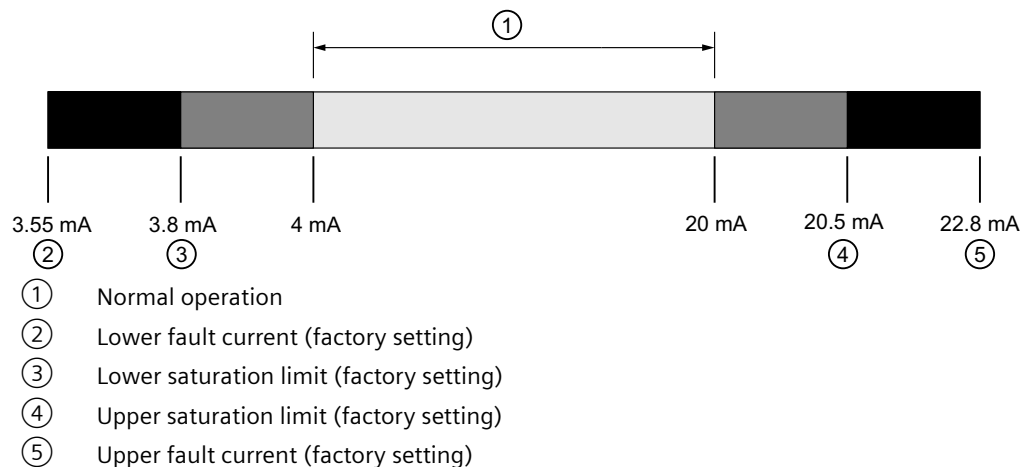

### 9.2.11 Lower saturation limit [13]

Sets the lower threshold for the lower saturation limit ③.

The loop current cannot drop below the set threshold.

Setting range:	Between lower fault current ② and 4 mA
Factory setting:	3.8 mA, or as specified in order

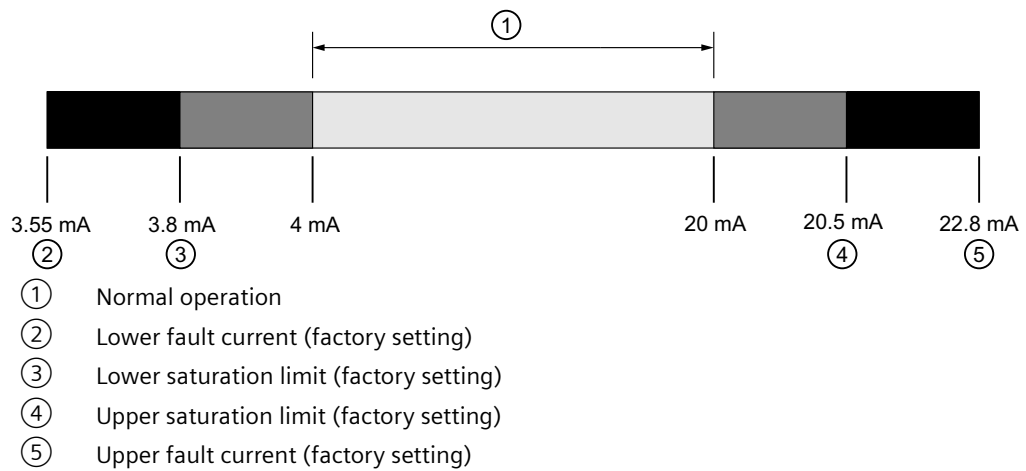

### 9.2.12 Upper saturation limit [14]

Sets the threshold for the upper saturation limit④.

Setting range:	Between 20 mA and the upper fault current
Factory setting:	20.5 mA, or as specified in order

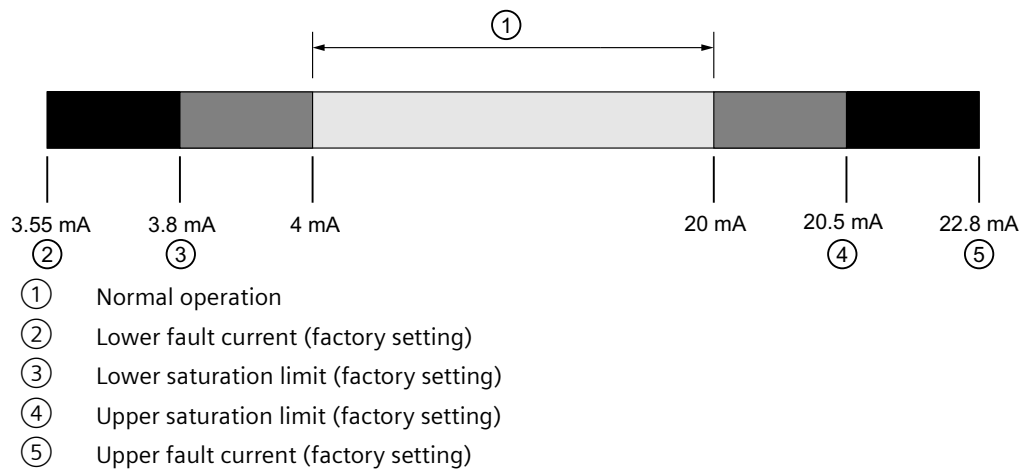



 <b>WARNING</b>
<b>Undetected failure in devices with functional safety</b>
Note the following:
<ul style="list-style-type: none"> <li>• For the maximum current output signal to be output, set the measuring range within the maximum permissible measuring span. You can find the maximum permissible measuring span of your measuring cell in the section Technical data (Page 211).</li> <li>• Note that a saturation limit &gt; 21.5 mA increases the risk of undetected failures. (Page 166)</li> <li>• When you configure your process control system, the analog input must distinguish between the measured value at saturation (current is <math>\leq 21.5</math> mA) and high fault current (current is <math>\geq 22.0</math> mA).</li> </ul>

### 9.2.13 SV selection [15]

Sets a measured value as a secondary variable (SV).

Setting range:	TEMP	Sensor temperature
	ETEMP	Electronics temperature
	LEVEL	Level
	VOL	Volume
	VFLOW	Volume flow
	USER	Custom
	MFLOW	Mass flow
Factory setting:	As specified in order	

### 9.2.14 Units [16]

#### Introduction

Depending on the application of the device that you have selected using the "Application" parameter, you have the option of selecting a unit:

- Level
- Volume
- Volume flow
- Mass flow

The selected unit is displayed in the measurement view.

Use the remote operation to set the associated unit for the "Customized characteristic curve" application.

**See also**

Application [05] (Page 112)

**9.2.14.1 Level units [16]**

Selects the unit for the "Level" measurement.

This parameter is only visible when you have selected the "Level" characteristic curve using the "Application" parameter.

Setting range:	m
	cm
	mm
	in
	ft
Factory setting:	m

**9.2.14.2 Volume units [16]**

Selects the unit for the "Volume" measurement.

This parameter is only visible when you have selected a volume characteristic curve using the "Application" parameter.

Certain units are displayed differently on the display and over remote operation. (Page 109)

Setting range:	Display (header line)	Display (enumeration)	Remote operation
	Gal	Ga	gal
	Gal [UK]	lGa	gal (UK)
	l	l	l
	hl	hl	hl
	m <sup>3</sup>	m <sup>3</sup>	m <sup>3</sup>
	in <sup>3</sup>	in <sup>3</sup>	in <sup>3</sup>
	Ft <sup>3</sup>	Ft <sup>3</sup>	ft <sup>3</sup>
	bu	bu	bu
	Yd <sup>3</sup>	Yd <sup>3</sup>	yd <sup>3</sup>
	bbbl	bbbl	bbbl
	bbbl [US]	Ubb	bbbl (US)
	Nl	Nl	Nl
	Nm <sup>3</sup>	Nm <sup>3</sup>	Nm <sup>3</sup>
	SCF	SCF	SCF
Factory setting:	m <sup>3</sup>		

**9.2.14.3 Volume flow units [16]**

Selects the unit for the "Volume flow" measurement.

This parameter is only visible when you have selected a volume flow characteristic curve using the "Application" parameter.

Certain units are displayed differently on the display and over remote operation. (Page 109)

Setting range:	Display (header line)	Display (enumeration)	Remote operation
	m3/sec	m3/S	m <sup>3</sup> /s
	m3/min	m3/m	m <sup>3</sup> /min
	m3/h	m3/h	m <sup>3</sup> /h
	m3/d	m3/d	m <sup>3</sup> /d
	l/Sec	l/S	l/s
	l/min	l/m	l/min
	l/h	l/h	l/h
	l/d	l/d	l/d
	FT3/Sec	Ft3/S	ft <sup>3</sup> /s
	Ft3/min	Ft3/m	ft <sup>3</sup> /min
	Ft3/h	Ft3/h	ft <sup>3</sup> /h
	Ft3/d	Ft3/d	ft <sup>3</sup> /d
	SCF/min	SCF/m	SCF/min
	SCF/h	SCF/h	SCF/h
	NI/h	NI/h	NI/h
	Nm3/h	Nm3/h	Nm <sup>3</sup> /h
	Gal[UK]/Sec	lGa/S	gal (UK)/s
	Gal[UK]/min	lGa/m	gal (UK)/min
	Gal [UK]/h	lGal/h	gal (UK)/h
	Gal[UK]/d	lGa/d	gal (UK)/d
	Gal/Sec	Ga/S	gal/s
	Gal/min	Ga/m	gal/min
	Gal/h	Ga/h	gal/h
	Gal/d	Ga/d	gal/d
	Mgal/d	MGl/d	Mgal/d
	bb/d	bb/d	bb/d
	bb/h	bb/h	bb/h
	bb/min	bb/m	bb/min
	bb/Sec	bb/S	bb/s
Factory setting:	m <sup>3</sup> /s		

#### 9.2.14.4 Mass flow units [16]

Selects the unit for the mass flow measurement.

This parameter is only visible when you have selected a mass flow characteristic curve using the "Application" parameter.

Certain units are displayed differently on the display and over remote operation. (Page 109)

Setting range:	Display (header line)	Display (enumeration)	Remote operation
	KG/Sec	KG/S	kg/s
	Gr/Sec	G/S	g/s
	Gr/min	G/m	g/min
	Gr/h	G/h	g/h
	KG/min	KG/m	kg/min
	KG/h	KG/h	kg/h
	KG/d	KG/d	kg/d
	t/min	t/m	t/min
	t/h	t/h	t/h
	t/d	t/d	t/d
	lb/Sec	lb/S	lb/s
	lb/min	lb/m	lb/min
	lb/h	lb/h	lb/h
	lb/d	lb/d	lb/d
	ton/min	sto/m	ton/min
	ton/h	sto/h	ton/h
	ton/d	sto/d	ton/d
	ton(UK)/h	Lto/h	ton (UK)/h
	ton(UK)/d	Lto/d	ton (UK)/d
Factory setting:	kg/s		

### 9.2.15 Temperature units [17]

Selects the temperature unit for the "Sensor temperature" and "Electronics temperature" measurements that are displayed in the measurement view.

Setting range:	K
	°C
	°F
	°R
Factory setting:	°C

### 9.2.16 Lower scaling point [18]

Sets the lower range value for the output scaling.

Depending on the application of the device, you set the lower scaling point as follows:

**Level**

Setting range:	Freely selectable numeric value
Factory setting:	0 m

**Volume**

Setting range:	Freely selectable numeric value
Factory setting:	0 m <sup>3</sup>

**Volume flow**

Setting range:	Freely selectable numeric value
Factory setting:	0 m <sup>3</sup> /s
Setting range:	Freely selectable numeric value
Factory setting:	0

**Mass flow**

Setting range:	Freely selectable numeric value
Factory setting:	0 kg/s
Setting range:	Freely selectable numeric value
Factory setting:	0

**Custom units**

Setting range:	Freely selectable numeric value
Factory setting:	USER DEFINED (custom), or as specified in order

The various applications are described in the section Application [05] (Page 112).

**9.2.16.1 Set lower scaling point**

1. Navigate to the parameter view.  
Navigating in the views (Page 77)
2. Select the "Lower scaling point" parameter [18].
3. Use the ► button to confirm.
4. Set the lower scaling point.

**9.2.17 Upper scaling point [19]**

Sets the upper range value for the output scaling.

Depending on the application of the device, you set the upper scaling point as follows:

**Level**

Setting range:	Freely selectable numeric value
Factory setting:	100 m

**Volume**

Setting range:	Freely selectable numeric value
Factory setting:	1000 m <sup>3</sup>

**Volume flow**

Setting range:	Freely selectable numeric value
Factory setting:	1000 m <sup>3</sup> /s

**Mass flow**

Setting range:	Freely selectable numeric value
Factory setting:	1000 kg/s

**Custom units**

Setting range:	Freely selectable numeric value
Factory setting:	USER DEFINED (custom), or as specified in order

**9.2.17.1 Set upper scaling point**

1. Navigate to the parameter view.  
Navigating in the views (Page 77)
2. Select the "Upper scaling point" parameter [19].
3. Use the  button to confirm.
4. Set the upper scaling point.

**9.2.18 Low flow cut-off [20]**

Sets the flow value for the low flow cut-off. The flow value is suppressed up to certain percentage of the output value.

The parameter is visible when you have selected the "Hold at 0, square root" (VSOFF or MSOFF) characteristic curve using the "Application" parameter.

Setting range:	0% - 100%
Factory setting:	10%

**See also**

Volume and mass flow measurements (Page 117)

### 9.2.19 Vessel dimension A [21]

Sets the height of the vessel bottom for the following vessel shapes:

- Conical bottom vessel (CONIC)
- Parabolic bottom vessel (PARAB)
- Half sphere bottom vessel (HALF)
- Flat sloped bottom vessel (FLAT)

For a lying parabolic ends vessel (PARAE) the set value corresponds to the height of the end piece.

You can find a figure with the different vessel shapes under "Volume measurement (Page 120)".

Setting range:	0 to 100%
Factory setting:	0%

For the calculated volume to correspond to the actual vessel volume, set the parameters Vessel dimension A and Vessel dimension L as follows:

- Vessel dimension L + 2 • Vessel dimension A = 100%.  
Example: Vessel dimension L is 80% and vessel dimension A is 10%.

<b>! WARNING</b>
<b>Overfilling the vessel</b>
To avoid overfilling the vessel, set a limit alarm: The limit must be below the maximum measuring range ① and have a sufficient minimum distance to the top edge of the vessel.

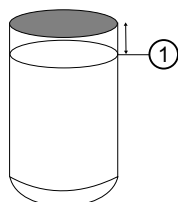

#### See also

Configuring limit monitoring (Page 157)

### 9.2.20 Vessel dimension L [22]

Sets the length of the bottom vessel for a lying parabolic ends vessel (PARAE).

You can find a figure with the different vessel shapes under "Volume measurement (Page 120)".

Setting range:	0 to 100%
Factory setting:	0%

For the calculated volume to correspond to the actual vessel volume, set the parameters Vessel dimension A and Vessel dimension L as follows:

- Vessel dimension L + 2 • Vessel dimension A = 100%.  
Example: Vessel dimension L is 80% and vessel dimension A is 10%.

### 9.2.21 Button lock [23]

Enables the button lock. You can continue to operate the device using remote operation.

Setting range:	ON	Button lock enabled
	OFF	Button lock disabled
Factory setting:	OFF	

#### 9.2.21.1 Enabling button lock

##### Procedure

1. Navigate into the parameter view.  
Navigating in the views (Page 77)
2. In the parameter view, select the "Button lock" parameter.
3. Press the ► button.  
The "EDIT" symbol flashes.
4. Select ON with the ▲ or ▼ button.



5. Use the ► button to confirm.

##### Result

- The display automatically returns to the measurement view.
- The display automatically changes between the measured values every 12 seconds.
- The symbol for button lock "LL" and the measured value ID are displayed alternately.

---

##### Note

For a device without display, you activate the button lock using remote operation.

---



### 9.2.21.2 Disabling button lock

#### Procedure

To disable the button lock, press and hold the ► button for 5 seconds.

#### Result

- The symbol for Button lock "LL" is hidden.
- You can operate the device using the buttons.

---

#### Note

For a device without display, you deactivate the button lock using remote operation.

---

### 9.2.22 Change user PIN [24]

Used to change the User PIN.

Setting range:	1 to 65535
Factory setting:	2457

#### Requirement

The "User PIN (Page 140)" parameter is enabled.

#### Procedure

1. Navigate to the parameter view.  
Navigating in the views (Page 77)
2. Select the parameter "Change user PIN".



3. Press the ► button.
4. Enter the old user PIN.

9.2 Parameter assignment over device with display

5. Enter the new user PIN with a value between 1 and 65535.  
Changing parameter values (Page 83)



6. Use the ► button to confirm.
7. Repeat the new user PIN and use the ► button to confirm.



**Result**

- If both user PINs match, the "COMPL" message appears. The user PIN has been successfully changed.
- If the two user PINs do not match, the "FAILD" message appears. Then repeat the described procedure.

**9.2.23 Recovery ID [25]**

Shows the recovery ID.

If you have forgotten your user PIN, you will need a recovery ID. The "Recovery ID" parameter shows a number that is necessary for restoring the user PIN.



Figure 9-2 Example

**9.2.23.1 Display Recovery ID**

**Requirements**

The "User PIN" parameter is enabled.

## Procedure

1. Navigate to the parameter view.  
Navigating in the views (Page 77)
2. Select the "Recovery ID" parameter.  
This Recovery ID is displayed.

## Result

Please contact the Technical Support (Page 272) with the displayed recovery ID and the serial number of your device.

You can find the serial number of the device on the nameplate or via remote operation.

Siemens Technical Support will give you a PUK (PIN Unlock Key) that you use to reset the user PIN to the factory setting 2457.

### 9.2.24 PIN recovery [26]

Used to reset the user PIN to the factory setting.

The user PIN is factory set to 2457 in the device.

#### 9.2.24.1 Recovering the user PIN

### Requirement

- You have received the PUK from Technical Support. (Page 138)
- The "User PIN (Page 140)" parameter is enabled.

### Procedure

1. In the parameter view, select the "PIN recovery" parameter.



2. Press the ► button.  
The cursor and the "EDIT" symbol flash.

9.2 Parameter assignment over device with display

3. Enter the digits of the PUK:
  - Use the ▲ or ▼ button to change.
  - Use the ► button to confirm.
  - Use the ◀ button to delete.

The complete PUK is shown on the top line of the display.

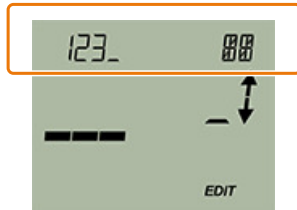

4. When the PUK is complete, use the ► button to confirm.

**Result**

- If you have entered the correct PUK, the message "NEW PIN - 2457" appears. The user PIN has been reset to the factory setting 2457.
- If the PUK was not correctly entered, the message "FAILED" appears. Then repeat the described procedure.

**9.2.25 User PIN [27]**

Used to enable or disable the user PIN.

Setting range:	ON	Enable user PIN
	OFF	Disable user PIN
Factory setting:	User PIN disabled	

When the user PIN is enabled, the measured values and parameters are read-only.

- To change the parameters and use the device functions, the user PIN must be input.

The user PIN 2457 is factory preset in the device.

**Note**

Write protection is automatically enabled 10 minutes after the last button operation.

- Enter the user PIN.

**9.2.25.1 Enable user PIN**

**Requirement**

The User PIN is disabled.

## Procedure

1. Navigate to the parameter view.  
Navigating in the views (Page 77)
2. Select the parameter "User PIN".
3. Use the ► button to confirm.  
The message "USER PIN ON" (User PIN enabled) appears for 2 seconds.

## Result

The User PIN is activated after about 10 minutes or after a device restart.



### 9.2.25.2 Disable user PIN

## Requirement

The user PIN is enabled.

## Procedure

1. Navigate to the parameter view.  
Navigating in the views (Page 77)
2. Select the parameter "User PIN".
3. Use the ► button to confirm.
4. Select YES with the ▲ or ▼ button.



5. Use the ► button to confirm.  
The message "USER PIN OFF" appears for 2 seconds.

**Result**

The User PIN is disabled.



**9.2.26 Active device mode [28]**

Shows the mode in which the device is operated.

The parameter is only visible for devices with Functional Safety.

Setting range:	STD	Functional Safety is disabled
	FUNCT	Validation of the safety-related parameters and/or the fail-safe behavior is performed
	SAFE	Functional Safety is enabled
	ERROR	Safety critical device error
	O/S	Out of service mode, non-safe mode
Factory setting:	STD	

You can find additional information on the device modes under Device mode (Page 168).

**9.2.27 Functional Safety [29]**

Enables Functional Safety.

The parameter is only visible for devices with Functional Safety.

**See also**

Functional Safety (Page 163)

**9.2.28 Display test [30]**

Used to check that numbers, texts and symbols appear correctly on the display.



- To start the Display test, press the ► button and select "START".  
When the Display test is complete, the message "COMPL" appears.
- To cancel the Display test, press the ◀ button.

## 9.2.29 Loop test [31]

Sets a constant loop current for test purposes.

You have the option of selecting preset values or a user-defined value.

Setting range:	3.55 mA	
	4 mA	
	12 mA	
	20 mA	
	22.8 mA	
	USER	User defined
Factory setting:	12 mA	

### 9.2.29.1 Loop test with preset loop current value

1. Navigate into the parameter view.  
Navigating in the views (Page 77)
2. Select the parameter "Loop test".
3. Use the ► button to confirm.



The loop test starts:

- The "EDIT" symbol flashes.
  - The "Function check" symbol is displayed.
  - The "Co" symbol (constant current mode) is displayed.
4. Change the preset value with the ▲ or ▼ button.
  5. Use the ► button to confirm.  
The loop test starts.
  6. End the loop test with the ◀ button.

**9.2.29.2 Loop test with user defined loop current value**

1. Navigate into the parameter view.  
Navigating in the views (Page 77)
2. In the parameter view, select the "Loop test" parameter.
3. Use the ► button to confirm.

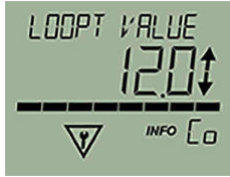

The loop test starts:

- The "EDIT" symbol flashes.
  - The "Function check" symbol is displayed.
  - The "Co" symbol (constant current mode) is displayed.
4. Change to "USER" with the ▲ or ▼ button.
  5. Use the ► button to confirm.
  6. Set a value between 3.6 mA and 22.8 mA using the buttons ▲ or ▼.
  7. Use the ► button to confirm.  
The loop test starts.
  8. End the loop test with the ◀ button.

**9.2.30 Start view [32]**

Selects the value that is displayed as the first measured value in the measurement view.

For the selection to take effect, change from the parameter view to the measurement view or restart the device.

Setting range:	Edit view	Measurement view
	PRESS	Pressure (P1)
	STEMP	Sensor temperature (P2)
	ETEMP	Electronics temperature (P3)
	LEVEL	Level (P4)
	VOL	Volume (P5)
	VFLOW	Volume flow (P6)
	MFLOW	Mass flow (P7)
	USER	Customized characteristic curve (P8)
	%	Percent of range (P9)
	LOOPC	Loop current (PA)
	CVOLT	Terminal voltage (PB)
Factory setting:	PRESS	



**Note**

To have the process value for "Level", "Volume", "Mass flow", "Volume flow" or "Customized characteristic curve" shown as the "Start view", first set the associated characteristic curve using the "Application" parameter.

**9.2.31 Pressure reference [33]**

Used to adapt the display of the pressure unit to your application.

Setting range:	NONE	Not specified
	GAUGE	Gauge pressure
	ABS	Absolute pressure
Factory setting:	NONE	

**See also**

Pressure units [01] (Page 108)

**9.2.32 Identify the device [34]**

Enables or disables the device identification via HART.

When device identification is enabled, the device signals its identification data via HART.

With device identification enabled, the device responds to a request with the HART command "Find device".

Setting range:	ON	Device identification enabled
	OFF	Device identification disabled
Factory setting:	OFF	

### 9.2.33 Reset [35]

#### 9.2.33.1 Reset parameters

Used to reset the following settings:

Setting range:	Restore ordered configuration	CUST
	Reset to sensor calibration	SENSR
	Reset DAC trim to the factory setting	DAC
	Factory reset	FACT

#### 9.2.33.2 Reset to sensor calibration

Resets the zero point and sensor calibration to the factory setting.

#### 9.2.33.3 Reset DAC trim to the factory setting

Resets the DAC trim (digital-to-analog converter trim) to the factory setting.

The DAC trim is used to calibrate the 4 mA and 20 mA end points of the analog output with an external reference (e.g. current measurement device).

The DAC trim is available over remote operation.

#### 9.2.33.4 Restore ordered configuration

With this function you return your device to its delivery state.

- The ordered configuration of the following parameters is restored:
  - Pressure units
  - Quick start
  - Pressure reference
  - Long tag (TAG)
  - Short tag (TAG)
  - Lower range value
  - Upper range value
  - Lower limit of the measuring range
  - Upper limit of the measuring range
  - Damping value
  - Application and related values (e.g.: vessel shapes and application points)
  - Fault current selection
  - Lower fault current
  - Upper fault current
  - Lower saturation limit
  - Upper saturation limit
  - Custom units
- The parameters that you have not configured via the order are reset to the factory settings.

#### 9.2.33.5 Restore factory settings

With this function you return your device to its factory setting.

The following settings are reset to the factory setting among other things:

- Sensor calibration
- DAC trim
- The defaults that you have configured in your order are overwritten with this function. These defaults can then deviate from the ordered configuration. To restore the ordered configuration, use the "Restore ordered configuration (Page 147)" parameter.

#### 9.2.34 Overload behavior [36]

Defines the reaction of the device when the measuring range of the sensor is exceeded (at overpressure or underpressure).

9.3 Parameter assignment over remote operation

If the parameter is set to "Warning", the current output follows the pressure value up to the configured saturation limits. If the parameter is set to "Alarm", the lower fault current ( $\leq 3.55$  mA) is output when the sensor is overloaded.

The parameter is only visible for devices with functional safety and is only effective if the device is in the "Functional Safety enabled" device mode.

Setting range:	WARN	Warning
	ALARM	Alarm
Factory setting:	ALARM or as specified in order	

The selected parameter setting influences the safety characteristics (Page 167).

## 9.3 Parameter assignment over remote operation

### 9.3.1 Introduction

This section describes the most important parameters and functions that are available additionally over remote operation:

- "Quick Start" wizard
- Identification (TAG)
- Simulation
- Customized characteristic curve
- Sensor calibration
- Digital-to-analog converter trim (DAC trim)
- Diagnostics functions
  - Limit monitoring and event counter (not available on SITRANS P320)
  - Trend log (not available on SITRANS P320)
  - Operating hours counter

### 9.3.2 Quick start

You use the "Quick start" wizard to configure your device in five steps for the required application:

- Step 1: Identification
- Step 2: Application
- Step 3: Scaling
 

Note that you set the displayed pressure unit with the "Pressure units" parameter and not with the wizard.

Set the unit of the selected application (e.g. volume, mass flow) also via the parameter group "Settings > Current output > Scaling > Unit".

- Step 4: Fault current
- Step 5: Summary  
The summary provides an overview of the "old" and "new" parameters.  
To store the parameters in SIMATIC PDM and transfer them to the device, click the "Apply" button.

### 9.3.3 Identification

Define the data that you need to identify your device under the "Identification" parameter group. A distinction is made between data you can set yourself and values that are preset in the factory.

The default values are write-protected and cannot be changed. The corresponding allocation is set out in the following example:

Parameter	Adjustable	Preset	Factory setting
Tag	X	-	
Long tag (TAG)	X	-	
Description	X	-	
Message	X	-	
Installation date	X	-	
Device			
Manufacturer	-	X	Siemens
Product name	-	X	SITRANS P420
Article number	-	X	e.g. 7MF0440-1GL01-5AF2-Z
Order option 1/ Order option 2	-	X	e.g. A01+C11+C12+C14+C20+E00+H01+Y01+Y15+Y21
Serial number	-	X	In accordance with the measuring cell selection/device manufacture
Final assembly number	X	-	
Hardware version	-	X	In accordance with the measuring cell selection/device manufacture
Firmware version	-	X	In accordance with the measuring cell selection/device manufacture
EDD version	-	X	
Sensor serial number	-	X	In accordance with the measuring cell selection/device manufacture
Sensor type	-	X	In accordance with the measuring cell selection/device manufacture
Maximum measuring span	-	X	In accordance with the measuring cell selection/device manufacture

### 9.3.4 Simulation

You can use the device to simulate the following via remote operation (e.g. field communicator, SIMATIC PDM):

- Input and output values
  - Constant pressure values
  - Ramp function
- Diagnostics

---

#### Note

The simulated pressure value has a direct effect on the configured process value (e.g. volume or flow rate) and thus on the current output dependent on it.

---

#### 9.3.4.1 Simulate constant pressure values

##### Procedure

To simulate a constant pressure value via remote operation (e.g. SIMATIC PDM), follow these steps:

1. For the "Simulation mode" parameter, set the "Enabled" option to simulate a constant pressure value.
2. Select the pressure value ("Process value") to be simulated from the drop-down list under the "Simulation selection" parameter.
3. For the "Simulation value" parameter, set the desired constant pressure value for the simulation.
4. Set status to be simulated for the "PV status" parameter.
5. Click "Transfer" to start the simulation.
6. For the "Simulation mode" parameter, set the "Disabled" option to stop the simulation.

##### Result

The measured value is replaced by a constant simulation value. The simulation influences the output signal.

The diagnostic ID "Cb" is displayed on the device.

### 9.3.4.2 Simulate ramp function

To simulate a ramp function via remote operation (e.g. SIMATIC PDM), follow these steps:

1. For the "Simulation mode" parameter, set the "Ramp" option to simulate a changing pressure value.
2. Select the pressure value ("Process value") to be simulated from the drop-down list under the "Simulation selection" parameter.
3. For the "Simulation value" parameter, set the desired start value for the simulation.
4. Set status to be simulated for the "PV status" parameter.
5. Set the "Ramp end" parameter .
6. Set the "Ramp steps" parameter to define the number of steps in the ramp simulation.
7. Set the "Ramp duration" parameter to define the time interval (in seconds) for each step in the simulation.
8. Click "Transfer" to start the simulation.
9. For the "Simulation mode" parameter, set the "Disabled" option to stop the simulation.

### 9.3.4.3 Simulate diagnostics

#### Procedure

To simulate diagnostics via remote operation (e.g. SIMATIC PDM), follow these steps:

1. Open the "Device" menu in SIMATIC PDM and select "Simulation > Diagnostics".
2. To put the device into simulation mode, press the "Enable" button in the "Simulation diagnostics" tab.  
(Button switches between "Enable" and "Disable").
3. Select the diagnostics you want to simulate from the drop-down box of the "Diagnostics" field.
4. Select "Action" for each selected diagnostic action to be simulated: "On" or "Off".
5. To start the simulation, click on the "Apply and transfer" button.

The diagnostic status of the simulation selected for each diagnostic is displayed in additional tabs in the dialog box. The simulated diagnostics is indicated by a check mark in the check box.

#### End diagnostics simulation

You close the simulation in the "Diagnostics simulation" tab:

- To disable a specific diagnostic action, click "Off" (under the "Action" field).
- To end the diagnostics simulation, click on the "Disable" button.

 <b>WARNING</b>
<b>When diagnostics simulation is enabled, diagnostic events of the real process are neither recorded nor evaluated.</b>
With activated diagnostics simulation, only the simulated diagnostics are displayed on the device display.
Stop diagnostics simulation immediately after use:
<ul style="list-style-type: none"><li>• Click "Disable" in the "Diagnostics simulation" tab before you close the "Diagnostics" dialog.</li><li>• Alternatively, you can restart the device.</li></ul>

### 9.3.5 Customized characteristic curve

#### 9.3.5.1 Introduction

For special applications, a customized characteristic curve is available.

This application is used, for example, for volume measurement in vessels with unusual shapes.

You specify the relationship between the input pressure and output value flow in accordance with your user-specific requirements.

You have up to 32 breakpoints available for this, which you enter using the engineering system and display graphically.

#### Example

For measurement with the customized characteristic curve, you set the following values, for example:

Damping value:	2.0 s
Lower range value:	0 bar
Upper range value:	10 bar
Application:	Custom (CUSTM)
Unit:	Cans
Lower scaling point:	0 cans
Upper scaling point:	250 cans
x values:	0%, 25%, 50%, 75%, 100%
y values:	0%, 25%, 50%, 75%, 100%

#### 9.3.5.2 "Custom units" parameter

Selects a custom unit.



The selected unit is displayed in the measurement view.

Setting range:	Up to 12 characters
Factory setting:	0 or as specified in order

This parameter is only visible when you have selected a custom characteristic curve using the "Application" parameter.

## See also

Display of measured values (Page 79)

### 9.3.5.3 Set customized characteristic curve

#### Requirement

- You have set the "Customized characteristic curve" application.
- You have set a custom unit.
- You have set the lower scaling point and the upper scaling point.

#### Procedure

1. Select the "Customized characteristic curve" menu.
2. Read the data from the device.
3. Enter the desired number of breakpoints.  
You can enter a minimum of two and up to 32 breakpoints.
4. Enter the x values and y values.

---

#### Note

The x values must increase monotonically. Otherwise, the x values are not accepted by the device.

The characteristic curve is displayed as diagram.

The x values are shown as pressure value or as percentage of the set pressure range.

The y values are displayed in the user-specific unit or as a percentage of the configured user-specific range.

5. Transfer the characteristic to the device.

#### Result

The output value now follows the set characteristic curve.

Values below the first breakpoint or above the last breakpoint are extrapolated.

## See also

Set application (Page 113)

### 9.3.6 Sensor calibration

You use the sensor calibration to set the characteristic curve of the device at two trim points. The results are then correct measured values at the sensor trim points.

The sensor trim points can be selected as any points within the nominal range.

Devices that are not turned down prior to delivery are trimmed at 0 bar and the high limit of the nominal range.

Devices that are turned down prior to delivery are trimmed at the low and high limits of the set measuring range.

## Examples

- For a particular device that is not turned down (e.g. 63 bar), the typical measured value is 50 bar. To attain the highest possible accuracy for this value, set the upper sensor trim at 50 bar.
- A 63-bar pressure transmitter is turned down to 4 to 7 bar. You can attain the highest possible accuracy by selecting 4 bar for the low trim point and 7 bar for the high trim point.
- A 250-mbar absolute pressure transmitter shows 25 mbar at 20 mbar. A reference pressure of 20 mbar is available. To correct the zero point, perform a sensor trim at the lower trim point with 20 mbar.

---

#### Note

Use a test device whose accuracy is at least three times as high as the accuracy of the pressure transmitter.

---

### Sensor calibration at the low calibration point

1. Use remote control (e.g. SIMATIC PDM) to select the menu command "Device > Sensor calibration".
2. Apply the pressure for the low calibration point at the device.
3. Apply the pressure value that you have created and assign the pressure value to the device. The device applies the set value.  
The device carries out an offset correction of the characteristic curve.

### Sensor calibration at the high calibration point

1. Use remote control (e.g. SIMATIC PDM) to select the menu command "Device > Sensor calibration".
2. Apply the pressure for the high calibration point at the device.  
The high calibration point needs to be greater than the low calibration point.
3. Apply the pressure value that you have created and assign the pressure value to the device.  
The device applies the set value.  
The device carries out an offset correction of the characteristic curve.  
The low calibration point is not affected by this.

### Result

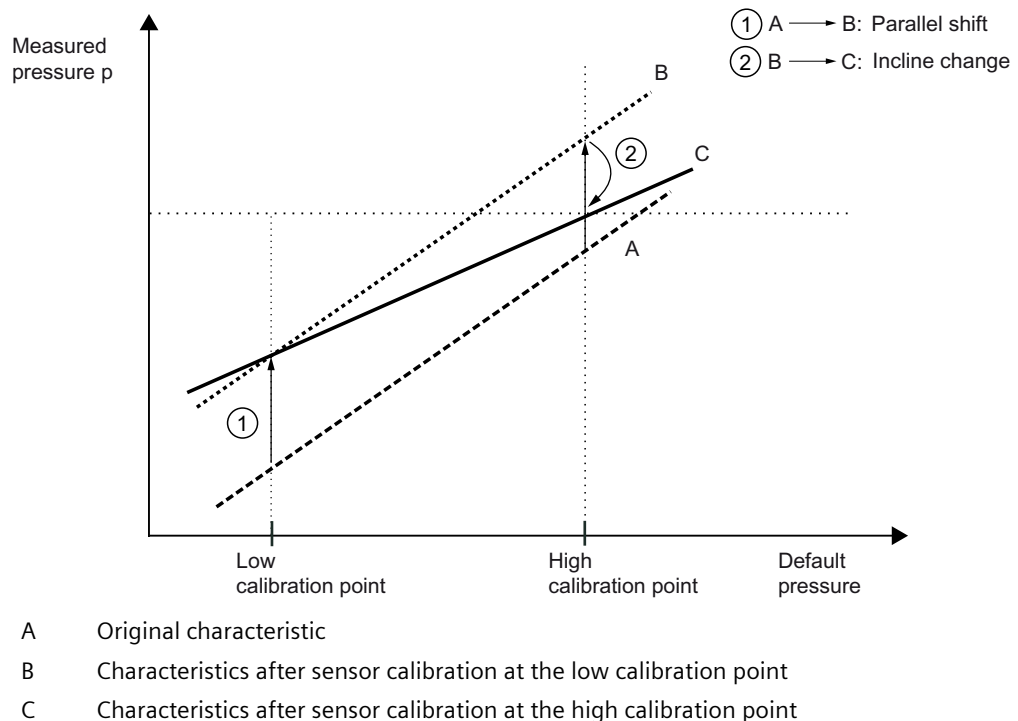

### 9.3.7 Digital-to-analog converter trim (DAC trim)

#### Introduction

The current that is output by the device can be trimmed independently of the measuring circuit. This function is designed for compensating inaccuracies in the processing chain following the device.

**Procedure**

- Trim at 4 mA:  
Use the menu command "DAC trim" to instruct the device to put out 4 mA. You read the measured value at an ammeter and enter this value. The device uses this value for offset correction of the current.
- Trim at 20 mA:  
Use the menu command "DAC trim" to instruct the device to put out 20 mA. You read the measured value at an ammeter and enter this value. The device uses this value for gradient correction of the current. The value for 4 mA is not affected by this.

**Note**

If a multimeter is used, it must always be sufficiently accurate.

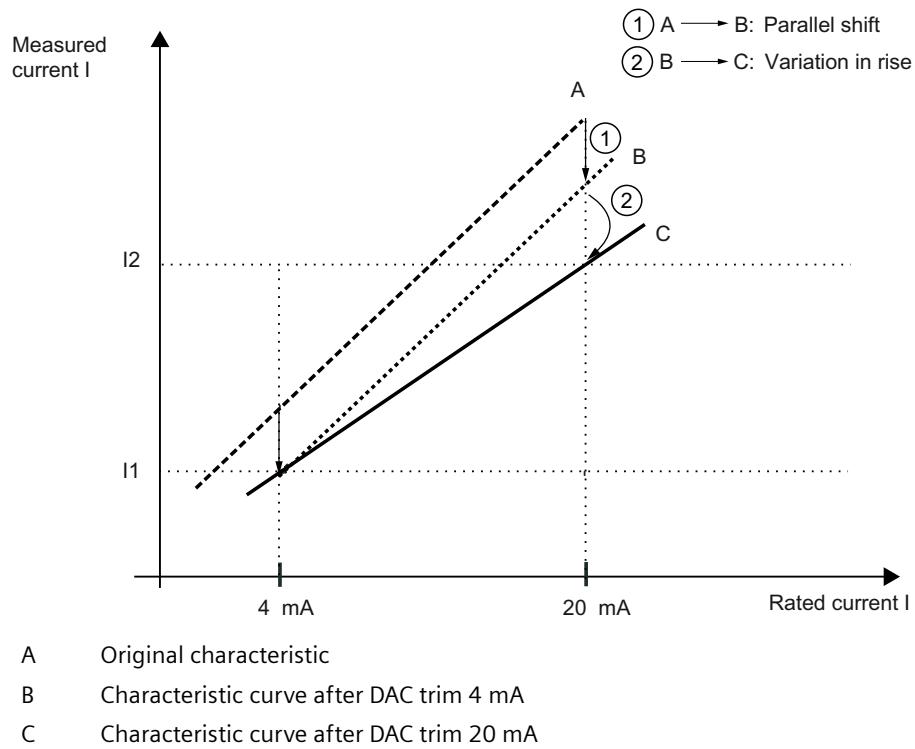

## 9.3.8 Diagnostics functions

### 9.3.8.1 Limit monitoring and event counter

#### Introduction

With the limit monitoring and event counter function, the following options are available to you via remote operation (e.g. SIMATIC PDM):

- Monitoring process values
- Counting events based on configured limits
- Triggering, acknowledging and resetting process value alarms and warnings.

#### Configuring limit monitoring

#### Procedure

1. Select the menu command "Device > Limit monitoring and event counter".  
The "Limit monitoring" tabs are displayed.
2. To trigger a process value alarm each time the value falls below or exceeds the limit, set the "Limit monitoring" text box to "Enabled".
3. Select the process value (e.g. sensor temperature) that you want to monitor from the "Monitored value" drop-down list.  
Configure only one process value per tab.
4. In the "Upper limit", "Lower limit" and "Hysteresis" text boxes, enter the values that trigger an event.  
If the process value rises above the upper limit (overrun) or falls below the lower limit (underrun), an event is counted based on the configured value for the hysteresis.  
Hysteresis (Page 159)
5. If necessary, configure the event counter.  
Configuring the event counter (Page 158)
6. Click on "Transfer".

#### Result

The process value alarm is displayed as a symbol for the status in the "Diagnostics > Device state" dialog of the engineering system and on the device screen.

It is not necessary to acknowledge the process value alarms.

If the monitored process value is again within the limit values, the process value alarm is reset.

## Configuring the event counter

### Requirement

You have configured the following values in limit monitoring:

- Upper limit
- Lower limit
- Hysteresis

Configuring limit monitoring (Page 157)

### Procedure

1. In the "Limit" text box, enter the number of underrun and overrun events that must be reached in order to trigger the action for underrun and overrun respectively.
2. From the "Action" drop-down list, select whether process value alarms or warnings (maintenance demanded and maintenance required) are triggered.
  - If you set the action to "Disabled", no new process value alarms or warnings for the set limit values are triggered, although the counter remains in operation.  
All process value alarms and warnings that were triggered before the action was set to Disabled remain pending until the event counter is reset.
3. Click on "Transfer".

### Result

The configured diagnostics are triggered after the specified number of limit violations has been reached (e.g. Maintenance required).

Process value alarms and warnings are displayed as symbols for the status in the "Diagnostics > Device state" dialog in the engineering system and on the device screen.

These process value alarms and warnings must be acknowledged.

Acknowledging process value alarms and warnings (Page 158)

## Acknowledging process value alarms and warnings

### Requirement

You have configured the event counter.

Configuring the event counter (Page 158)

### Procedure

1. Select the menu command "Device > Limit monitoring and event counter".
2. Click "Reset and acknowledge".

## Result

Process value alarms and warnings are acknowledged and deleted.

The event counter is reset.

## Hysteresis

The hysteresis works as follows:

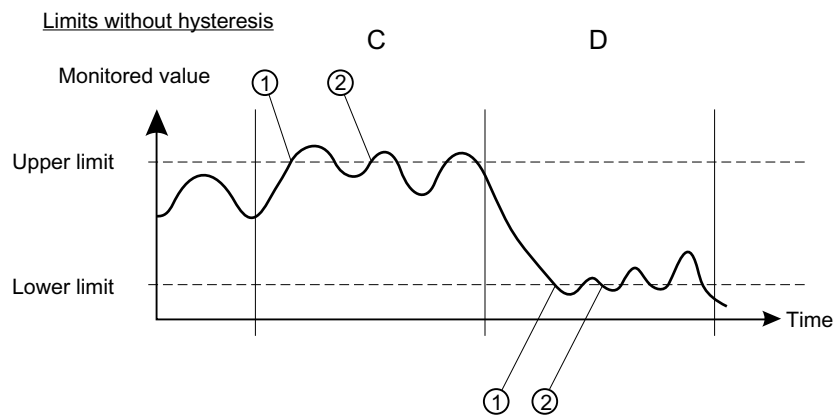
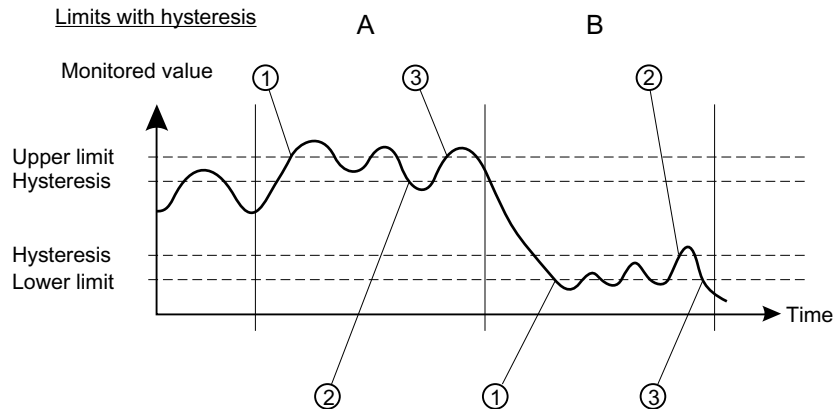

## Limits with hysteresis

If you enter a non-zero value in the "Hysteresis" text box, the hysteresis is disabled.

### Upper limit with hysteresis (A)

An overrun event is counted when the process value rises above the upper limit ①.

The next overrun event is counted when the process value falls below the lower limit minus the entered hysteresis ② and then rises above the upper limit ③.

Two events are counted in the displayed time period within 'A'.

### Lower limit with hysteresis (B)

An underrun event is counted when the process value falls below the lower limit ①.

The next underrun event is counted when the process value first rises above the lower limit plus the entered hysteresis ②, and then falls below the lower limit ③.

Within 'B', two events are counted in the displayed period.

### Limits without hysteresis

If you enter the value "zero" in the "Hysteresis" text box, the hysteresis is disabled.

### Upper limit without hysteresis (C)

An overrun event is counted when the process value rises above the upper limit ①.

The next overrun event is counted when the process value falls below the upper limit ② by any value, and then rises above the upper limit ②.

Within 'C', three events are counted in the displayed period.

### Lower limit without hysteresis (D)

An underrun event is counted when the process value falls below the lower limit ① by any value.

If the process value falls below the lower limit by any value ②, the next underrun event is counted again.

Two events are counted in the displayed period within 'D'.

### See also

Configuring limit monitoring (Page 157)

### 9.3.8.2 Trend log

#### Set trend log

1. Select the menu command "Device > Trend log settings".
2. Define the number of process values you wish to log.
3. Use the "Logging behavior" parameter to define the buffer behavior.
  - To fill the buffer with a variable number of logging points between 1 to 735 per process value, select "Fill and stop".  
The buffer is deleted and filled up to the number of set logging points. Then logging is stopped.
  - If you select the buffer behavior "Overwrite", the buffer is completely deleted. After the buffer size of 735 logging points per process value has been reached, the 15 oldest logging points are cyclically replaced with 15 new logging points.
4. In the "Logging interval" parameter, enter the interval in seconds between the logging points.



5. Select the process values you want to record.
6. Click on "Transfer" to write the log settings to the device.  
The buffer with the existing logging points is deleted and overwritten with new logging points.

### Show trend log

1. Select the menu command "Diagnostics > Trend log".
2. Click on "Read".
  - The number of available process values is displayed.
  - The current number of logging points per process value that are already in the buffer is displayed.
  - The time stamp for the start time is displayed.
3. To show the first or second process value in the chart, enable the associated check box.
4. Click on "Read".
  - The logging points in the buffer are read from the device and shown in the chart.
  - The process values for pressure and sensor temperature are shown in different colors in the chart.

When you click on "Reset", the buffer is deleted and trend logging starts again.

### 9.3.8.3 Operating hours counter

#### Operating hours counter for transmitter electronics

- Monitors the number of operating hours during which the transmitter remained in continuous operation.
- Starts with the first commissioning at the factory.
- The operating hours counter cannot be reset or adjusted.

#### Operating hours counter for sensor electronics

- Is only displayed when the measuring transducer electronics was replaced.
- Monitors the number of operating hours during which the sensor electronics remained in continuous operation.

### Procedure

1. Use remote operation (e.g. SIMATIC PDM) to select the menu command "Diagnostics > Device status".
2. Select the "HART status" tab.  
The operating time and, if available, the sensor operating time is displayed.



# Functional Safety

## Introduction

This section includes the required additional information for parameter assignment, commissioning and maintenance of the device in a safety-instrumented system.

## 10.1 Safety concept

The device was developed in accordance with the Safety Integrity Level (SIL), which is defined as a relative level of risk reduction offered by a safety function.

The individual device has a hardware fault tolerance of 0 (HFT = 0) and a systematic suitability of 3. The device is classified as Type B device.

- The device meets the requirements of SIL 2 in single-channel safety-related systems.
- The device meets the requirements of SIL 3 in two-channel safety-related systems, when a comparison function for checking the output of the two redundant devices comprising a redundant system is implemented.

### 10.1.1 Random and systematic errors

Random errors can occur at any time. An example is an electronic circuit that is faulty immediately.

Systematic errors occur under specific conditions and are reproducible, if the same conditions arise again. An example is a software error that occurs under certain conditions.

There are random and systematic errors in hardware, but only systematic errors in software.

---

#### Note

##### Limitations in redundant systems

Redundancy significantly reduces the probability of a failure of the safety function due to a random error but not the probability of systematic errors.

---

### 10.1.2 SIL-compliant product version

Information on specific versions that are permitted for use in safety-related systems according to IEC 61508 can be found in the manufacturer's declaration of conformity for the device (SIL Declaration of Conformity, Functional Safety according to IEC 61508).

**See also**

Product documentation (Page 271)

General functional safety (<http://www.siemens.com/safety>)

Functional safety in process instrumentation (<http://www.siemens.com/SIL>)

**10.1.3 Use in furnaces**

You can find instructions and information on specific versions that are permitted for use in safety-related systems according to EN 50156-2 in the declaration of conformity "Electrical equipment for furnaces and ancillary equipment according to EN 50156-2".

**See also**

Product documentation (Page 271)

**10.1.4 Safety function**

The safety function of the device is the pressure measurement or the measurement of certain process values which can be calculated from the pressure value.

The 4 to 20 mA analog output can be used as part of a safety instrumented function (SIF).

Ensure that you have only connected one device per channel and that the current output is activated.

Besides the application-specific measuring errors under default reference conditions, an additional safety accuracy of  $\pm 2\%$  of the set maximum measuring span must be added:

Total tolerance (safety function) =  $\pm$  [application-specific measurement error + 2% safety accuracy in reference to the set measuring span].

**Example**

A silo is to be securely monitored to check that the level does not exceed 10 meters.

Application-specific measurement error: 0.1%

Safety accuracy: 2.0%

Total tolerance: 2.1%

2.1% of 10 meters is 21 centimeters. When process monitoring is set to 9.79 meters, safe shutdown is guaranteed even in the event of a random individual error within the safety accuracy.

---

**Note**

**Use of remote seals**

If remote seals are used, the application-specific measurement error is the product of the pressure transmitter and remote seal measurement errors.

---

### Safety allowance

The diagnostics function reacts within 2 seconds after detection of an error.

### Note

For use outside the standard reference conditions, contact Siemens to define an additional safety accuracy.

### See also

Remote seals and primary element for devices with functional safety (Page 41)

### Safety-instrumented system in single-channel operation (SIL 2)

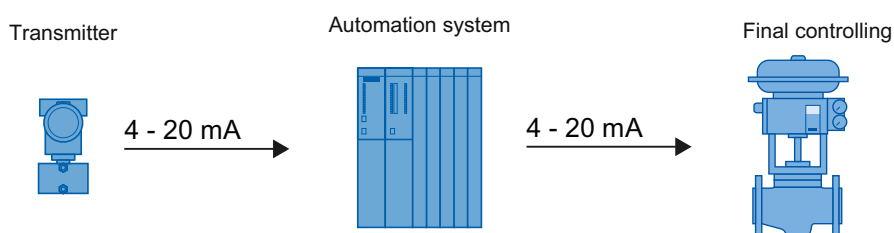

Figure 10-1 Safety-instrumented system in single-channel operation

The combination of pressure transmitter, automation system and final controlling element forms a safety-instrumented system that performs fail-safe behavior. The focus of this description is on the pressure transmitter. For information on requirements for the automation system or final controlling element, please refer to the corresponding standards.

The pressure transmitter generates a process-related measured value that is transferred to the automation system. The automation system monitors this measured value. If the measured value violates the preset high or low limit, the automation system generates a shutdown signal for the connected final controlling element, which switches the corresponding valve to the specified safety position.

Only one SITRANS P device is required for single-channel operation for SIL 2.

### Safety-instrumented system in multi-channel operation (SIL 3)

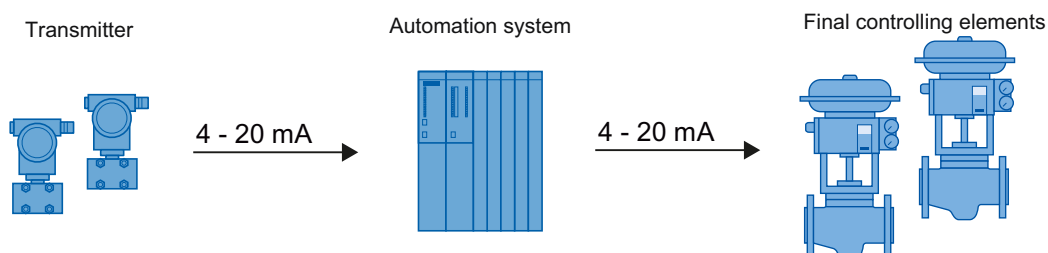

Figure 10-2 Safety-instrumented system in multi-channel operation

The combination of transmitter, automation system and final controlling element forms a safety-instrumented system that performs a safety function. The emphasis of this description is on the

10.1 Safety concept

transmitter. For information on requirements for the automation system or final controlling element, please refer to the corresponding standards.

The transmitter generates process-related measured values that are transferred to the automation system. The automation system monitors these measured values. In the event of a fault, the automation system generates shutdown signals for connected final controlling elements that set the associated valve to the defined safety position. Faults are:

- Violations of the preset high or low limits
- Deviations between the two measured values

The automation system program must monitor the measured values of both SITRANS P devices. As soon as the measured values differ by e.g. 2% or more, the system must be brought into the safe state and the fault must be located.

Two SITRANS P devices are required for multi-channel operation for SIL 3. Operation with one device is not permitted.

**Note**

**Switching-off of system at high monitoring accuracy**

The two transmitters are connected to the process at different positions. Actual differences in pressure  $\geq$  the total tolerance (safety function) can occur when the process is started up or if there are other pressure variations. A difference in pressure  $\geq$  the total tolerance (safety function) will shut down the system.

- Match the monitoring accuracy of the automation system to the process.
- Mount the two transmitters exposed to equal conditions.

**10.1.4.1 Device states**

The following table provides a definition of the states of the device:

Device state	Description	Error class
Normal mode (4-20 mA)	The safe current output outputs the measured value within the defined safety accuracy.	-
Detected failure (safe state)	The safe current output is $\leq 3.6$ mA or $> 21.5$ mA (specified as failure signal).	$(\lambda_{DD})$ Rate of dangerous detected errors
Dangerous state	A dangerous state exists when a current output is in the range 4-20 mA and deviates from the correct process value by more than the specified safety accuracy (Page 164) for more than 2 seconds.	$(\lambda_{DU})$ Rate of dangerous undetected errors

#### 10.1.4.2 Safety characteristic values

You can find the safety characteristic values in the SIL Declaration of Conformity.

---

##### Note

##### Useful lifetime

Constant failure rates are assumed for the calculation of PFD/SFF. This assumption is valid for environmental conditions that are typical for an industrial environment, corresponding to IEC 60654-1 class C (weatherproof locations) with an average long-term temperature of 40°C. After 14 years, however, the failure rates may increase.

---

#### See also

Product documentation (Page 271)

#### 10.1.5 Operating modes of the device

The device can be operated as follows:

- "Functional Safety disabled" is used for operation in non-safety-related applications.
- "Functional Safety enabled" is used for operation in safety-related applications.

#### See also

Enabling Functional Safety (Page 170)

### 10.1.6 Device mode

When Functional Safety is disabled, the following device modes are displayed via the display or remote operation:

Device mode	Display	Description	Current output value	Safe current output
Functional Safety disabled	STD	Used for operation in non-safety-related applications. The safety-related parameters of the device are set.	Operating signal (4 to 20 mA)	No
	FUNCT	The safety-relevant parameters and the safety function are validated.		
Out of service, non-safe mode	O/S	The device is out of service (e.g. a firmware update is running)	Failure signal ( $\leq 3.6$ mA or $> 21.5$ mA)	No

When Functional Safety is enabled, the following device modes are displayed via the display or remote operation:

Device mode	Display	Description	Current output value	Safe current output
Functional Safety enabled	SAFE	Ensures safe measurement output at the current output.	Operating signal (4 to 20 mA)	Yes
Safety-related error	ERROR	The system has detected a safety-critical error in "Functional Safety enabled" device mode. The errors are listed in the error list of the device. Once the errors have been eliminated, the device can only be put back into safe operation by performing the safety validation.	Failure signal ( $\leq 3.6$ mA or $> 21.5$ mA)	Yes

**See also**

Active device mode [28] (Page 142)

Safety-related parameters (Page 169)

Enabling Functional Safety (Page 170)



### 10.1.6.1 Validation

In "Functional Safety disabled" device mode, you have the option of making the following validations before you enable Functional Safety:

- Validation of safety-related parameters.  
This validation ensures that all safety-related parameters are correctly transferred to the device.
- Validation of the safety function (function test).

#### See also

Enabling Functional Safety (Page 170)

### 10.1.6.2 Safety-related parameters

The following parameters are the safety-related parameters of the device:

Parameter ID	Parameter name on the display	Meaning
S1	PV SELECT	Pressure is the primary variable. The parameter cannot be changed.
S2	DAMPING	Damping value [04] (Page 112)
S3	UPPER RANGE	Set upper range value parameter [03] (Page 110)
S4	LOWER RANGE	Set lower range value parameter [02] (Page 110)
S5	APPLICATION	Set application (Page 113)
S6	OVERLD BEHAV	Overload behavior [36] (Page 147)
S7	SATURAT HIGH	Upper saturation limit (Page 128)

To set these parameters, change the device mode to "Functional Safety disabled".

### 10.1.6.3 Device mode "Functional Safety enabled"

In "Functional Safety enabled" device mode, an internal diagnostics process of the device performs the following safety-related checks:

- Sensor breakage monitoring
- Continuous testing of execution and logic behavior of CPU, analog-to-digital converter and memory
- Temperature monitoring
- Pressure monitoring, depending on the setting of the Overload behavior [36] (Page 147) parameter.
- Integrity of safety-related parameters
- Plausibility check of current output

When a safety-related critical error is detected in the device, the current output signal corresponds to the fault current ( $\leq 3.55$  mA) and is independent of the settings of the following parameters:

Select fault current [10] (Page 126),  
Lower fault current [11] (Page 126),  
Upper fault current [12] (Page 127),  
Lower saturation limit [13] (Page 127),

---

**Note**

As long as the device is in the "Functional Safety enabled" device mode, all parameters are protected against changes.

- To change the parameters, disable Functional Safety.
- 

**Note**

Before you enable Functional Safety, follow these steps:

- Setting safety-relevant parameters
- Setting the zero point (Page 122)
- Sensor calibration (Page 154)
- Digital-to-analog converter trim (DAC trim) (Page 155)

The items listed above are tested with the function test (Page 169) of the Functional Safety.

---

## 10.2 Enabling Functional Safety

You enable or disable Functional Safety with the "Functional Safety" wizard.

The wizard is available via the device with a display and via remote operation.

For a device without display, enable Functional Safety via remote operation.

You have the following options for enabling Functional Safety:

1. Enable Functional Safety after validation of safety-related parameters and safety function (recommended).
2. Enabling Functional Safety after validation of safety-related parameters and without validation of safety function (recommended).
3. Enable Functional Safety without validation.

### See also

Validation (Page 169)

Acknowledging safety-related errors (Page 178)

Checklist for Functional Safety (Page 277)

## 10.2.1 Enabling Functional Safety over device with display

### Requirement

- You have checked the settings of the safety-related parameters.  
Safety-related parameters (Page 169)

#### Note

The main line of the display has a measured value display with a maximum of five digits.

- To completely display the measured values for upper range value [S3] and lower range value [S4] by means of the maximum five digits available, set the pressure units correspondingly.
- You have selected one of the following characteristic curves using the "Application" parameter [05]:
  - Linear, proportional to pressure (PRESS).
  - Linear, proportional to level (LEVEL).
  - Proportional to flow rate, two-step linear up to the application point (VSLN2 or MSLN2).
- You have enabled the "User PIN" parameter [27].  
The user PIN you use is not the preset user PIN (2457).

### Procedure

- Navigate to the parameter view.  
Navigating in the views (Page 77)
- Select the parameter "Functional Safety" [29].
- To start the wizard, enter the user PIN if needed.
- Use the ► button to confirm.  
The display test runs automatically.
- Check that the numbers, texts and symbols are displayed correctly.



- Once the display test is complete, start the validation of the safety-related parameters and the safety function.  
When you select "ENABL", you enable Functional Safety directly without validation of the safety-related parameters and the safety function.



**Validating safety-related parameters**

1. Select "VALID".



2. Use the ► button to confirm.
3. Navigate to the safety-related parameters with the ► button. To correct the safety-related parameters, exit the wizard with the ◀ button. Use the ► button to confirm.

**Note**

Write protection via user PIN is automatically enabled 10 minutes after the last button operation. The wizard therefore aborts and the validation of the safety-related parameters is lost.

- To start the wizard again, enter the user PIN.

4. To complete validation of the safety-related parameters, confirm with YES.



5. To validate the safety function, start the function test with "START". When you select "SKIP", you skip the function test and enable Functional Safety directly without validation of the safety function.

**Validate safety function**

1. Check the correct execution of the safety function in which the device is used.
2. In the parameter view, select the "Functional Safety" parameter [29].
3. To continue with the wizard, enter the user PIN if needed.
4. Select "START".



5. Use the ► button to confirm.



6. When you have successfully validated the safety function, restart the wizard and select "PASSD".



The message "SAFETY MODE ON" (Functional Safety enabled) appears.

## Result

The device is in the "Functional Safety enabled" device mode.



Figure 10-3 Parameter view

- The "SIL" symbol is displayed.
- The "DSABL" command appears (Disable Functional Safety).
- All parameters are protected against changes.
- When a safety-related error is detected on the device, the device changes to "Safety critical error" device mode (Page 178).

## See also

Troubleshooting Functional Security (Page 209)

Diagnostic messages (Page 202)

## 10.2.2 Enabling Functional Safety over remote operation

### Requirement

- You have documented the device identification:
  - During installation, you have read and documented the product name and the serial number on the nameplate of the device.
  - You have defined and documented a long tag (Page 149).
- You have checked the settings of the safety-related parameters. Safety-related parameters (Page 169)
- You have selected one of the following characteristic curves using the "Application" parameter [05]:
  - Linear, proportional to pressure
  - Linear, proportional to level
  - Volume flow: two step linear, square root.
  - Mass flow: two step linear, square root.
- You have enabled the "User PIN" parameter [27]. The user PIN you use is not the preset user PIN (2457).

### Procedure

1. Select the menu command "Functional Safety".
2. Enter the user PIN.

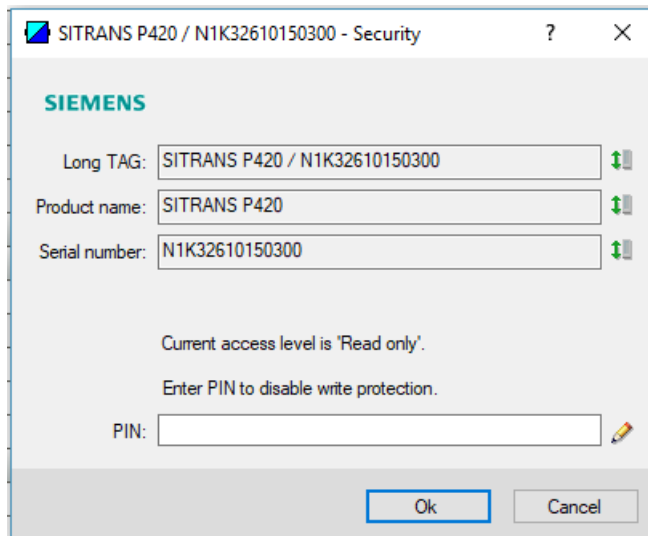

3. Validate the following settings:
  - Identification data of your device: Long tag, product name, serial number.
  - Settings of the safety-related parameters  
To change the settings, exit the wizard with "Cancel".

SIEMENS

Long TAG: SITRANS P420 / N1K32610150300

Product name: SITRANS P420

Serial number: N1K32610150300

Validate settings:

PV selection	S1 PRESS	Pressure
Damping value	S2 0.0000 sec	
Upper range value	S3 0.2496 bar	
Lower range value	S4 -0.0001 bar	
Application	S5 PRESS	Pressure: Linear
Overload behavior	S6 ALARM	Alarm
Upper saturation limit	S7 20.500 mA	

Fingerprint: 2724

Validation key: 63868

Enter validation key: 63868

Start Function test Skip Function test Cancel

4. Write down the fingerprint.  
Whenever you start the validation, the device generates a fingerprint. By comparing the fingerprint, you determine whether or not the device and the safety-related parameters have changed erroneously during activation of the functional safety.

- 5. To confirm the validation, enter the validation key.

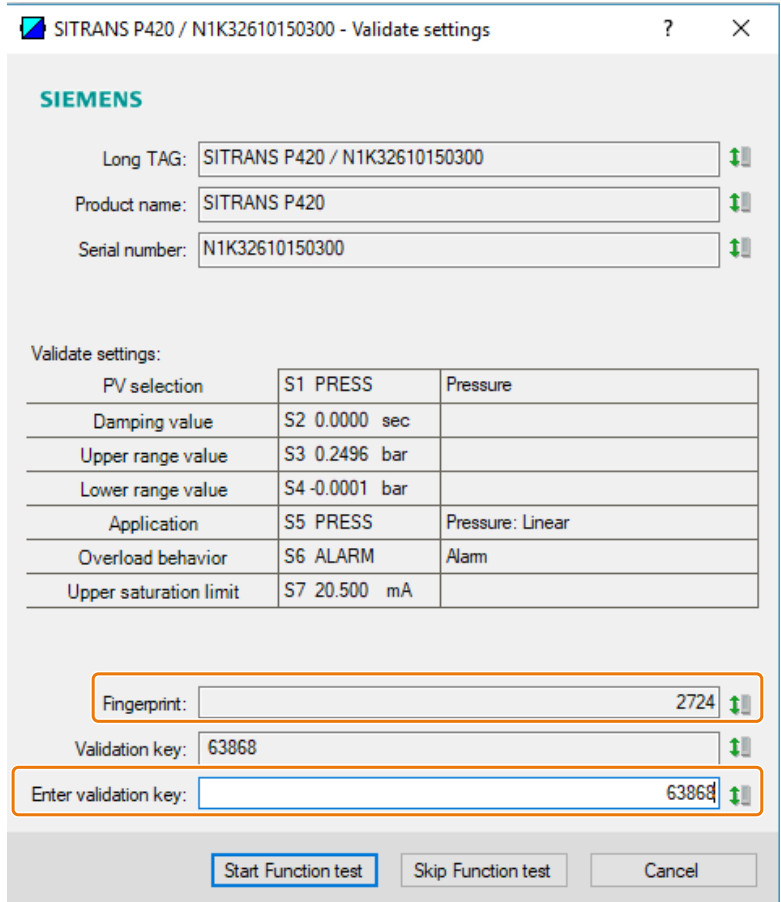

- 6. To validate the safety function, start the function test. The device changes to the "Safety validation" device mode.

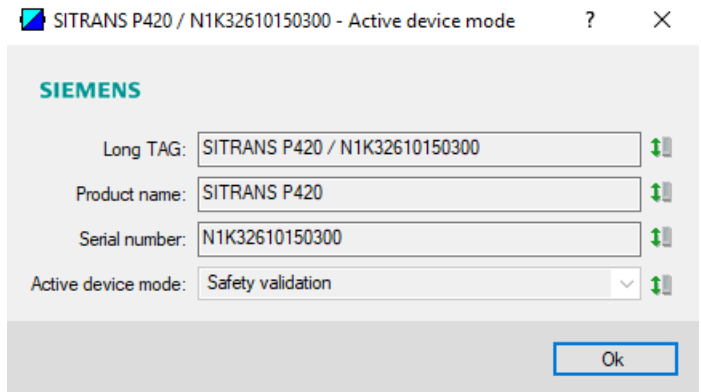

- 7. Confirm with "OK".

**Validate safety function**

- 1. Check the correct execution of the safety function in which the device is used.
- 2. Select the "Functional Safety" wizard.



3. Enter the user PIN.

4. Validate the identification data of your device.
5. Check that the displayed fingerprint matches the fingerprint you have written down.
6. Confirm the successful function test.

## Result

The device is in the "Functional Safety enabled" device mode.

- All parameters are protected against changes.
- When a safety-related error is detected on the device, the device changes to "Safety critical error" device mode (Page 178).

---

### Note

The system shows unexpected data or behaves differently than described in this procedure.

- Repeat the entire procedure.
- 

## See also

Diagnostic messages (Page 202)

## 10.3 Acknowledging safety-related errors

### 10.3.1 "Safety critical error" device mode

When a safety-related error is detected on the device, the current output signal corresponds to the fault current and the diagnostic message is displayed.



Figure 10-4 Example: Diagnostic message for overview

Acknowledge the safety-related error with the "Functional Safety" parameter [29] via local operation or via the menu command "Functional Safety" through remote operation. (Page 179)

The device then restarts and returns to the "Functional Safety disabled" device mode.

---

#### Note

**The system shows unexpected data or behaves differently than described in this procedure.**

- Repeat the entire procedure.

---

#### Note

**Damaged device**

- Replace the device.
- 

#### See also

Select fault current [10] (Page 126)

## 10.3.2 Acknowledging safety-related errors via remote operation

### Procedure

1. Select the menu command "Functional Safety".
2. Enter the user PIN.

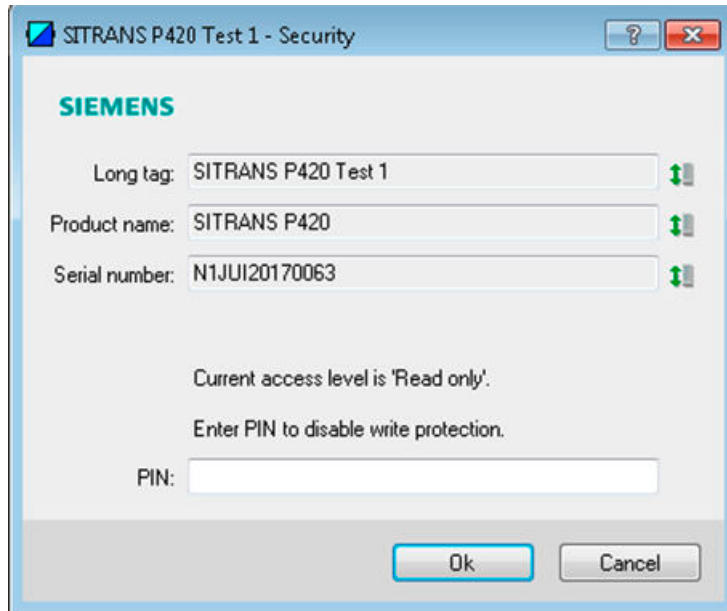

3. Validate the identification data of your device: Long tag, product name and serial number.

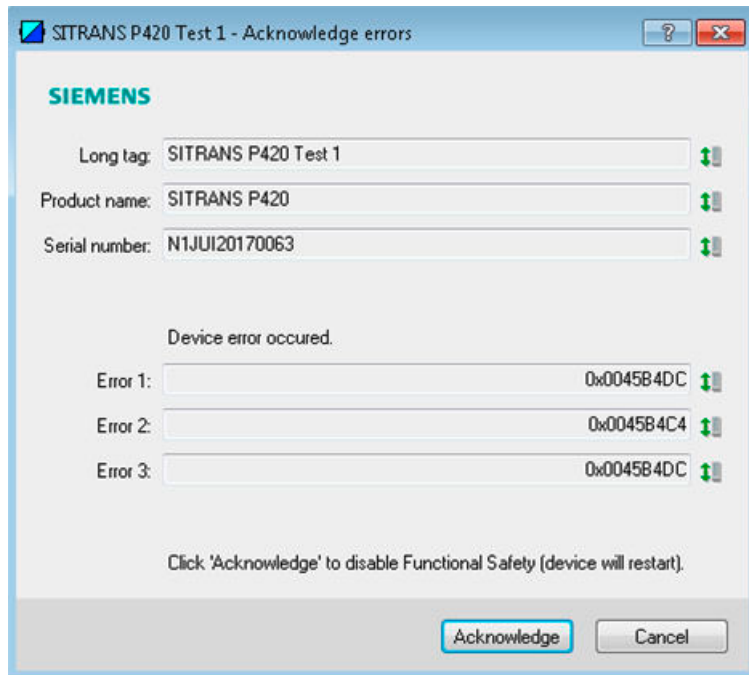

10.4 Disabling Functional Safety over device with display

4. To acknowledge the safety-related error, click on "Acknowledge".  
The device restarts automatically.

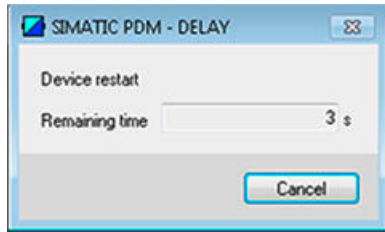

5. Validate the identification data of your device again: Long tag, product name and serial number.

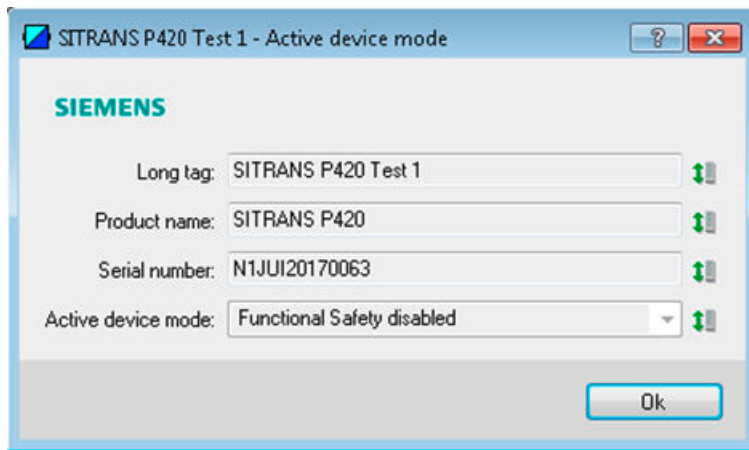

**Result**

- The safety-related error is acknowledged.
- The device returns to the "Functional Safety disabled" device mode.

---

**Note**

The system shows unexpected data or behaves differently than described in this procedure.

- Repeat the entire procedure.
- 

## 10.4 Disabling Functional Safety over device with display

**Requirement**

The device is in the "Functional Safety enabled" device mode.

## Procedure

1. Navigate to the parameter view.  
Navigating in the views (Page 77)
2. Select the parameter "Functional Safety" [29].
3. Enter the user PIN.  
The wizard starts.
4. Select YES immediately and confirm with the ► button.



## Result

The device switches to "Functional Safety disabled" device mode.

- The "SIL" symbol is hidden.
- The "ENABL" command appears (Enable Functional Safety mode).

---

### Note

If Functional Safety remains enabled, repeat the procedure described above without any interruptions.

---

## 10.5 Disabling Functional Safety over remote operation

### Requirement

The device is in the "Functional Safety enabled" device mode.

### Procedure

1. Select the menu command "Functional Safety".
2. Enter the user PIN.
3. Validate the identification data of your device: Long tag, product name and serial number.
4. Confirm with "Ok" that you want to disable Functional Safety.
5. Validate the identification data of your device again: Long tag, product name and serial number.
6. Confirm with "OK".

## Result

The device is in the "Functional Safety disabled" device mode.

---

### Note

**The system shows unexpected data or behaves differently than described in this procedure.**

- Repeat the entire procedure.
- 

## 10.6 Proof test

With proof tests you detect errors in the device that are not detected by the integrated diagnostics of the device.

When you conduct proof test regularly, you will uncover undetected errors that would otherwise cause the failure of safety-related functions.

### Intervals and rules

Thanks to the design of the device with a low rate of dangerous failures, it is possible to use the device over the entire useful lifetime at low maintenance costs.

The following maintenance work is required:

- Basic maintenance  
Basic maintenance (Page 182)
- Extended proof test when the requirements of the safety-related system or the regulatory requirements require this test.  
Extended proof test (Page 183)  
The interval of the extended proof test depends on the safety-related system.  
Based on the combined calculations of the failure rates for your system, you define the interval of the extended proof test.

---

### Note

For a safety-related system, we recommend testing the device annually.

---

### 10.6.1 Basic maintenance

#### All devices

Read the information on maintenance intervals and checking the seals and cable glands in the section Maintenance and repair work (Page 192).

## Absolute pressure devices

Set the zero point every 5 years for the following variants:

Measuring cell	Absolute pressure from the relative pressure/Absolute pressure with front-flush diaphragm	Absolute pressure from the differential pressure series
250 mbar a/25 kPa a/100 H <sub>2</sub> O	7MF0.2. - .F ... - ....	7MF0.3. - .G ... - ....
1300 mbar a/130 kPa a/525 H <sub>2</sub> O	7MF0.2. - .L ... - ....	7MF0.3. - .L ... - ....
5000 mbar a/500 kPa a/72.5 psi a	7MF0.2. - .P ... - ....	7MF0.3. - .P ... - ....
30 bar a/3 MPa a/435 psi a	7MF0.2. - .R ... - ....	7MF0.3. - .R ... - ....

You can find information on how to set the zero point for absolute pressure in section Adjusting zero point (absolute pressure) (Page 123)

### Note

To set the zero point, first disable Functional Safety.

## 10.6.2 Extended proof test

### Introduction

An extended proof test uncovers dangerous errors up to a certain degree (Proof Test Coverage).

The Proof Test Coverage of the proof test depends on the two-point measurement:

Proof Test Coverage	Two-point measurement as percentage of the maximum measuring range
90%	≥ 20%
99%	≥ 50%

When you are testing the device with a limited measuring span (20% of the maximum measuring range), you will also detect 99% of the errors.

### Before You Start

The device is already installed in the plant.

Alternatively, make sure that the device is installed in the same position as in the plant during the proof test.

### Procedure

1. Disable the safety function or prevent that the safety function is triggered.
2. Maintain the device as described in the following section:  
Basic maintenance (Page 182)

3. Check on the display that the device is in the "Functional Safety enabled" device mode and that no safety-related error messages are displayed:



Alternatively, check the following in SIMATIC PDM:

- Identification data (tag name, product name, serial number)
  - Device mode via the "Functional Safety > Active device mode"
4. Check the current output signal by simulating a safety-related error.  
Simulating a safety-related error (Page 184)
  5. Depending on the desired Proof Test Coverage, start one of the two-point measurements:  
Two-point measurement  $\geq 20\%$  of the maximum measuring range (Page 185)  
Two-point measurement  $\geq 50\%$  of the maximum measuring range (Page 187)
  6. Enable the safety function again.  
Alternatively, make sure that the safety function is once again guaranteed.

### See also

Device status display (Page 83)

Enabling Functional Safety (Page 170)

### 10.6.3 Simulating a safety-related error

Simulate a safety-related error by switching off the supply voltage of the device and switching it back on.

#### Procedure

1. Switch off the supply voltage.
2. Switch on the supply voltage.

---

#### Note

The device will resume the measurement operation after about 4 seconds after the supply voltage has been switched on.

---

3. Check the measured fault current before the device starts the measurement operation.

#### Result

When the power output signal is equal to the low fault current of  $\leq 3.55$  mA, the test is successful.



When the power output signal deviates from the low fault current of  $\leq 3.55$  mA, the test has failed:

- The safety integrity level is no longer guaranteed.
  - Replace the device.

#### 10.6.4 Two-point measurement $\geq 20\%$ of the maximum measuring range

With the two-point measurement you check the output current of two known input pressure values.

The procedure for the proof test depends on how the pressure value is monitored by the safety-related system:

- Falling below the limit
- Exceeding the limit

##### Before You Start

- The difference between the first input pressure and the second input pressure is  $\geq 20\%$  of the maximum measuring range.
- The functional safety of the device is enabled.

---

##### Note

##### Monitoring for falling below / exceeding the limit

For a successful test select the input pressure values so that the following conditions are being met:

- The measuring range to be tested is  $\geq 20\%$  of the maximum measuring range.
  - The monitored limit is below the URL and within the measuring range to be tested.
-

**Monitoring for falling below the limit**

**Example**

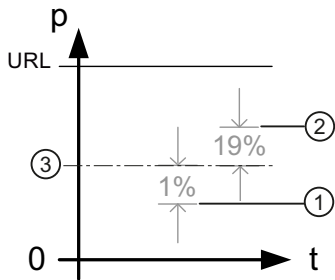

- URL Upper range limit (upper end of the measuring range)
- ①, ② Known input pressure values
- ③ Limit

1. As reference, use limit ③ that is defined for the safety-related system.
2. Apply a first known input pressure ① that is  $\geq 1\%$  below the limit.
3. Measure the output current.
4. Compare the output current with the first input pressure.
5. Apply a second known input pressure ② that is  $\geq 19\%$  above the limit.
6. Measure the output current.
7. Compare the output current with the second input pressure.

**Monitoring for exceeding the limit**

**Example**

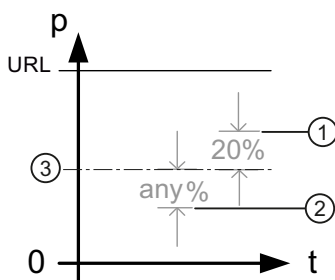

- URL Upper range limit (upper end of the measuring range)
- ①, ② Known input pressure values
- ③ Limit

1. As reference, use limit ③ that is defined for the safety-related system.
2. Apply a first input pressure ① that is  $\geq 20\%$  above the limit.
3. Measure the output current.
4. Compare the output current with the first input pressure.

5. Apply a second random input pressure ② that is below the limit.
6. Measure the output current.
7. Compare the output current with the second input pressure.

## Result

When the deviation between input pressure and measured output current is  $\leq 0.4\%$ , then the two-point measurement is successful.

In case of a failed two-point measurement, the safety integrity level (SIL) is no longer guaranteed.

- Replace the device.

### 10.6.4.1 Example

For a device with a maximum measuring range of 250 mbar, monitor the pressure value for the limit of 60 mbar to be exceeded.

- 0 mbar correspond to 4 mA
- 60 mbar correspond to 12 mA
- Permitted deviation:  $16 \text{ mA} \cdot 0.4\% = 0.064 \text{ mA}$

## Procedure

1. Apply a first input pressure that is equal to 20% of the maximum measuring range and that is above the monitored limit: 110 mbar
2. Apply a second random input pressure that is below the monitored limit: e.g. 59 mbar  
The two-point measurement is successful with the following values:

Input pressure	Output current
110 mbar	$18.667 \text{ mA} \pm 0.064 \text{ mA}$
59 mbar	$11.867 \text{ mA} \pm 0.064 \text{ mA}$

3. To achieve a Proof Test Coverage of 90%, observe all steps of the extended proof test: Extended proof test (Page 183)

### 10.6.5 Two-point measurement $\geq 50\%$ of the maximum measuring range

With the two-point measurement you check the output current of two known input pressure values.

The procedure for the proof test depends on how the pressure value is monitored by the safety-related system:

- Falling below the limit
- Exceeding the limit

**Before You Start**

- The difference between the first input pressure and the second input pressure is  $\geq 50\%$  of the maximum measuring range.
- The functional safety of the device is enabled.

---

**Note**

**Monitoring for falling below / exceeding the limit**

For a successful test select the input pressure values so that the following conditions are being met:

- The measuring range to be tested is  $\geq 50\%$  of the maximum measuring range.
  - The monitored limit is below the URL and within the measuring range to be tested.
- 

**Monitoring for falling below the limit**

**Example**

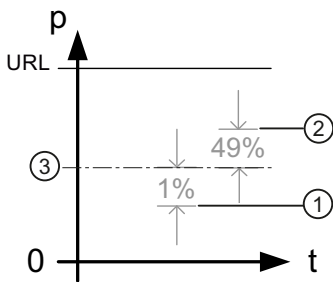

- URL Upper range limit (upper end of the measuring range)
- (1), (2) Known input pressure values
- (3) Limit

1. As reference, use limit (3) that is defined for the safety-related system.
2. Apply a first known input pressure (1) that is  $\geq 1\%$  below the limit.
3. Measure the output current.
4. Compare the output current with the first input pressure.
5. Apply a second known input pressure (2) that is  $\geq 49\%$  above the limit.
6. Measure the output current.
7. Compare the output current with the second input pressure.

## Monitoring for exceeding the limit

### Example

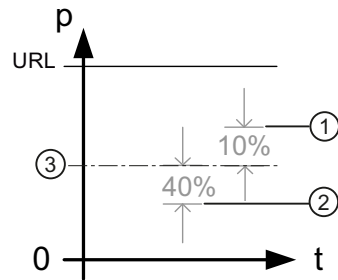

URL Upper range limit (upper end of the measuring range)

①, ② Known input pressure values

③ Limit

1. As reference, use limit ③ that is defined for the safety-related system.
2. Apply a first known input pressure ① that is  $\geq 10\%$  above the limit.
3. Measure the output current.
4. Compare the output current with the first input pressure.
5. Apply a second known input pressure ② that is  $\geq 40\%$  below the limit.
6. Measure the output current.
7. Compare the output current with the second input pressure.

## Result

When the deviation between input pressure and measured output current is  $\leq 1\%$ , then the two-point measurement is successful.

In case of a failed two-point measurement, the safety integrity level (SIL) is no longer guaranteed.

- Replace the device.

### 10.6.5.1 Example

For a device with a maximum measuring range of 250 mbar, monitor the pressure value for the limit of 200 mbar to be exceeded.

- 0 mbar correspond to 4 mA
- 200 mbar correspond to 16.8 mA
- Permitted deviation:  $16 \text{ mA} \cdot 1\% = 0.16 \text{ mA}$

**Procedure**

1. Apply a first input pressure that is equal to 10% of the maximum measuring range and that is above the monitored limit: 225 mbar
2. Apply a second input pressure that is 40% below the monitored limit: 100 mbar  
The two-point measurement is successful with the following values:

Input pressure	Output current
225 mbar	18.4 mA ± 0.16 mA
100 mbar	10.4 mA ± 0.16 mA

3. To achieve a Proof Test Coverage of 99%, observe all steps of the extended proof test: Extended proof test (Page 183)

**10.6.6 Documenting a proof test**

Documentation of the results of the proof test must be part of the safety management system of the installation. Errors that are of critical importance for Functional Safety must be reported to Siemens Technical Support (Page 272).

**10.7 Repair and service**

<b>NOTICE</b>
<b>Repair and service</b>
Repair and service work may only be performed by personnel authorized by Siemens.

## Service and maintenance

### 11.1 Basic safety instructions

The device is maintenance-free. However, a periodic inspection according to pertinent directives and regulations must be carried out.

An inspection can include, for example, check of:

- Ambient conditions
- Seal integrity of the process connections, cable entries, and cover
- Reliability of power supply, lightning protection, and grounds

#### **WARNING**

##### **Dust layers above 5 mm**

Risk of explosion in hazardous areas. Device may overheat due to dust build up.

- Remove dust layers in excess of 5 mm.

#### **WARNING**

##### **Use of a computer in a hazardous area**

If the interface to the computer is used in the hazardous area, there is a risk of explosion.

- Ensure that the atmosphere is explosion-free (hot work permit).

#### **CAUTION**

##### **Releasing button lock**

Improper modification of parameters could influence process safety.

- Make sure that only authorized personnel may cancel the button locking of devices for safety-related applications.

#### **NOTICE**

##### **Penetration of moisture into the device**

Device damage.

- Make sure when carrying out cleaning and maintenance work that no moisture penetrates the inside of the device.

## 11.2 Cleaning

### 11.2.1 Cleaning the enclosure

#### Cleaning the enclosure

- Clean the outside of the enclosure with the inscriptions and the display window using a cloth moistened with water or a mild detergent.
- Do not use any aggressive cleansing agents or solvents, e.g. acetone. Plastic parts or the painted surface could be damaged. The inscriptions could become unreadable.

<b>NOTICE</b>
<b>Improper cleaning of diaphragm</b>
Device damage. The diaphragm can be damaged.
<ul style="list-style-type: none"><li>• Do not use sharp or hard objects to clean the diaphragm.</li></ul>



### 11.2.2 Servicing the remote seal measuring system

The remote seal measuring system usually does not need servicing.

If the mediums are contaminated, viscous or crystallized, it could be necessary to clean the diaphragm from time to time. Use only a suitable solvent to remove the deposits from the diaphragm. Do not use corrosive cleaning agents. Prevent the diaphragm from getting damaged due to sharp-edged tools.

## 11.3 Maintenance and repair work

 <b>WARNING</b>
<b>Impermissible repair of explosion protected devices</b>
Risk of explosion in hazardous areas
<ul style="list-style-type: none"><li>• Repair must be carried out by Siemens authorized personnel only.</li></ul>



 **WARNING****No maintenance interval has been defined**

Device failure, device damage, and risk of injury.

- Define a maintenance interval for recurring tests depending on the use of the device and your own experience.
- The maintenance interval will vary from site to site depending on corrosion resistance.

 **WARNING****Maintenance during continued operation in a hazardous area**

There is a risk of explosion when carrying out repairs and maintenance on the device in a hazardous area.

- Isolate the device from power.
- or -
- Ensure that the atmosphere is explosion-free (hot work permit).

 **WARNING****Impermissible accessories and spare parts**

Risk of explosion in areas subject to explosion hazard.

- Only use original accessories or original spare parts.
- Observe all relevant installation and safety instructions described in the instructions for the device or enclosed with the accessory or spare part.

 **WARNING****Hot, toxic or corrosive process media**

Risk of injury during maintenance work.

When working on the process connection, hot, toxic or corrosive process media could be released.

- As long as the device is under pressure, do not loosen process connections and do not remove any parts that are pressurized.
- Before opening or removing the device ensure that process media cannot be released.

 <b>WARNING</b>
<b>Improper connection after maintenance</b> Risk of explosion in areas subject to explosion hazard. <ul style="list-style-type: none"><li>• Connect the device correctly after maintenance.</li><li>• Close the device after maintenance work.</li></ul> Refer to Technical data (Page 211).

 <b>CAUTION</b>
<b>Hot surfaces</b> Risk of burns during maintenance work on parts having surface temperatures exceeding 70 °C (158 °F). <ul style="list-style-type: none"><li>• Take corresponding protective measures, for example by wearing protective gloves.</li><li>• After carrying out maintenance, remount touch protection measures.</li></ul>

### 11.3.1 Checking the seals

#### Inspect the seals at regular intervals

---

**Note**

**Incorrect seal changes**

Incorrect measured values will be displayed. Changing the seals in a process flange of a differential pressure measuring cell can alter the lower range value.

- Changing seals in devices with differential pressure measuring cells may only be carried out by personnel authorized by Siemens.
- 

**Note**

**Using the wrong seals**

Using the wrong seals with flush-mounted process connections can cause measuring errors and/or damage the diaphragm.

- Always use seals which comply with the process connection standards or are recommended by Siemens.
- 

1. Clean the enclosure and seals.
2. Check the enclosure and the seals for cracks and damage.
3. If necessary, lubricate the seals or replace them.

### 11.3.2 Check cable glands

- Check the tightness of the cable glands at regular intervals.
- Tighten the cable glands if necessary.

### 11.3.3 Replacing spare parts

#### 11.3.3.1 Replacing electrical connections and cable entries

##### Procedure

1. Read the operating data and the approval information on the nameplates of your device.
2. Order a suitable electrical connection or cable entry for your device (cable gland, sealing plug or device plug).  
To do this, use the article number "7MF7906-..".

##### Notes for cable glands and device plugs

- When you order a cable gland or a device plug as spare part, consider the following criteria:
  - Thread
  - Material
  - Approval
  - IP degree of protection
  - Permissible ambient temperature
- The permissible ambient temperature for devices with dust explosion protection deviates from the permissible ambient temperature of the cable gland and the device plug. You should therefore not use any cable glands or device plugs from third-party manufacturers for devices with dust explosion protection.

#### 11.3.3.2 Replacing the display

##### Removing the display

1. De-energize the device.
2. Use a 3 mm Allen key to loosen the front safety catch.
3. Unscrew the front cover.

4. Remove the display from the holder.

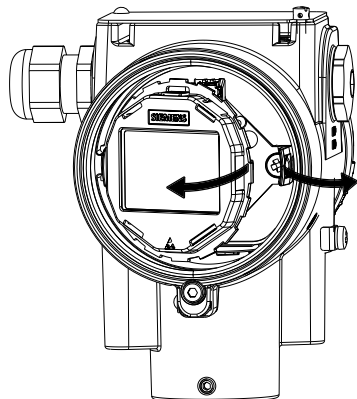

5. Disconnect the cable of the display from the 4-pole connector ①.

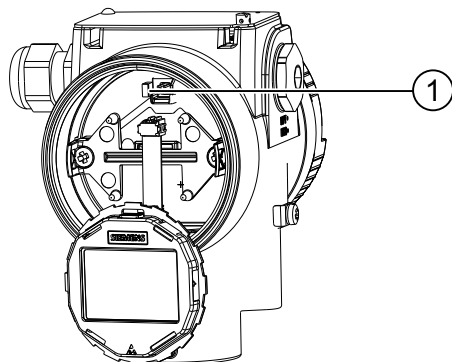

### Installing the display

1. Connect the cable of the display with the 4-pole connector ① by observing the poling:

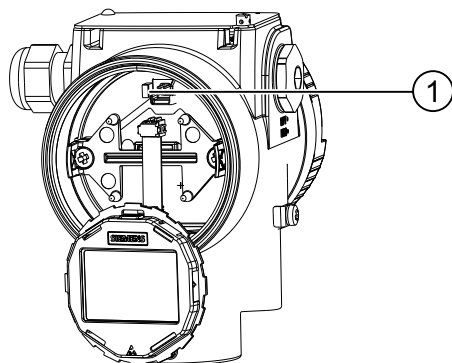

2. Fasten the display in the holder.

### 11.3.3.3 Replacing the termination board

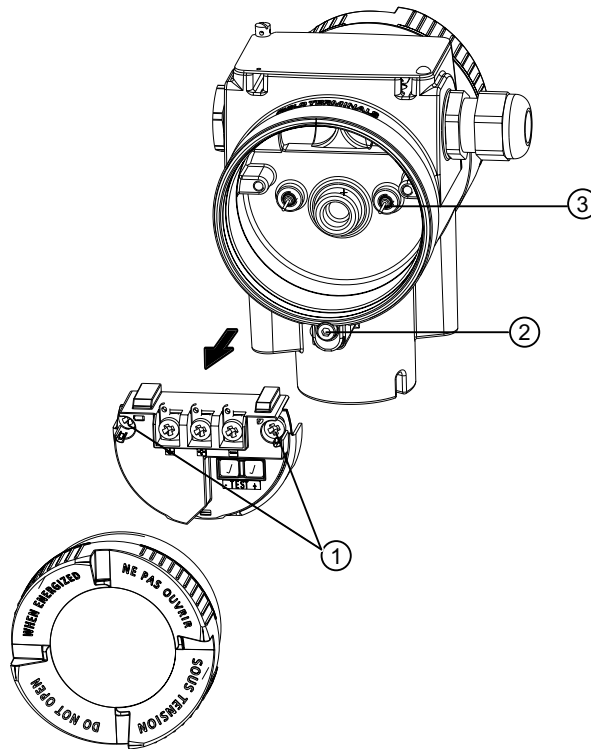

#### Removing the termination board

1. De-energize the device.
2. Use a 3 mm Allen key to loosen the front safety catch (2).
3. Open the cover of the electronic connection compartment.
4. Disconnect the cables from the termination board.
5. On the left and right side, remove the recessed-head screws (1) that hold the termination board to the enclosure.
6. Remove the termination board.

#### Installing the termination board

1. Insert the new termination board so that its contact pins (3) fit on the rear of the termination board.
2. Work in the reverse order to that described in "Removing the termination board".

## 11.4 Return procedure

Enclose the bill of lading, return document and decontamination certificate in a clear plastic pouch and attach it firmly to the outside of the packaging.

### Required forms

- Delivery note
- Return document (<http://www.siemens.com/processinstrumentation/returngoodsnote>) with the following information:
  - Product (item description)
  - Number of returned devices/replacement parts
  - Reason for returning the item(s)
- Decontamination declaration (<http://www.siemens.com/sc/declarationofdecontamination>)  
With this declaration you warrant "that the device/replacement part has been carefully cleaned and is free of residues. The device/replacement part does not pose a hazard for humans and the environment."  
If the returned device/replacement part has come into contact with poisonous, corrosive, flammable or water-contaminating substances, you must thoroughly clean and decontaminate the device/replacement part before returning it in order to ensure that all hollow areas are free from hazardous substances. Check the item after it has been cleaned. Any devices/replacement parts returned without a decontamination declaration will be cleaned at your expense before further processing.

## 11.5 Disposal



Devices described in this manual should be recycled. They may not be disposed of in the municipal waste disposal services according to the Directive 2012/19/EC on waste electronic and electrical equipment (WEEE).

Devices can be returned to the supplier within the EC, or to a locally approved disposal service for eco-friendly recycling. Observe the specific regulations valid in your country.

Further information about devices containing batteries can be found at: Information on battery/product return (WEEE) (<https://support.industry.siemens.com/cs/document/109479891/>)

---

### Note

#### Special disposal required

The device includes components that require special disposal.

- Dispose of the device properly and environmentally through a local waste disposal contractor.
-

## Diagnostics and troubleshooting

### 12.1 Device status symbols

Device status is shown using symbols on the local display. Additionally, the symbol and respective text message for each device status can be seen in remote engineering, asset management or process control systems.

Locally, alarms are shown as a symbol in the lower line of the display. If several diagnostic states are active at the same time, the symbol for the most critical state is shown.

#### Device status characteristics

The following table provides possible cause of device status and actions for the user or service.

The symbols used on the local display are based on NAMUR status signals, whereas symbols used in SIMATIC PDM are based on Siemens standard alarm classes.

---

#### Note

##### Device status priority conflict - Namur vs Siemens standard

When more than one diagnostic event is active simultaneously, a conflict in priorities may arise. In this case, the Namur symbol on the local display will differ from that shown in SIMATIC PDM.

- For example: if both diagnostic states "Maintenance demanded" and "Configuration error" are active,
  - Local display (using Namur symbols) will show "Configuration error" as higher priority.
  - SIMATIC PDM (using Siemens standard symbols) will show "Maintenance demanded" as higher priority.

Be aware of the priority for each device status, depending on the interface used.

---

#### Note















##### Priorities of the NAMUR device status

This device uses the priorities of the NAMUR device status based on the HCF specification.







---

The order of the symbols in the table corresponds to the priority of the device status, starting with the most critical message.

## Device status symbols

Display – NAMUR NE 107		NAMUR – HCF	SIMATIC PDM/PLC		
Symbol	Device status	Priority *	Symbol	Device status	Priority *
	Failure	1		Maintenance alarm	1
<b>Cause:</b> Output signal invalid due to fault in the field device or in the peripherals. <b>Measure:</b> Maintenance is required immediately.					
	Maintenance re- quired	4		Maintenance demanded	2
<b>Cause:</b> Output signal is still valid, but wear reserve is almost exhausted and/or a function will be limited soon. <b>Measure:</b> Maintenance is strongly recommended as soon as possible.					
	Maintenance re- quired	4		Maintenance required	3
<b>Cause:</b> The output signal is still valid. No functional restrictions have been determined but the wear reserve will most likely be exhausted in the next few weeks. <b>Measure:</b> Maintenance of device should be planned.					
	Function test	2		Manual operation	4
<b>Cause:</b> Output signal temporarily invalid (e.g. frozen) due to work being performed on the device. <b>Measure:</b> Manual mode over HMI or disable the engineering system.					
	Function test	2		Simulation mode	5
<b>Cause:</b> The output signal does temporarily not reflect the process because the output is based on a simulation value. <b>Measure:</b> Simulation mode over HMI or disable the engineering system or restart device.					
	Failure	1		Out of service	6
<b>Cause:</b> The output signal does not represent the process value. The device mode is set to "Out of service". <b>Measure:</b> Disable "Out of service" and enable normal operation.					
	Failure	1	 (red)	Configuration error	7
<b>Cause:</b> Output signal invalid due to parameter setting, connection error or configuration error in the HW. <b>Measure:</b> Check hardware configuration of the device over HMI or engineering system.					



Display – NAMUR NE 107		NAMUR – HCF	SIMATIC PDM/PLC		
Symbol	Device status	Priority *	Symbol	Device status	Priority *
	Out of specification	3		Process value alarm	8
<p><b>Cause:</b> Deviations from permissible ambient or process conditions detected by the device (by means of self-monitoring or based on warnings/errors in the device) indicate that the measured value is unreliable or that deviations from the set value in the actuators are most likely greater than anticipated under normal operating conditions.</p> <p>Process or ambient conditions can damage the device or result in unreliable results.</p> <p><b>Measure:</b> Check ambient temperature or process conditions. If possible, install device at different location.</p>					
	Function test	2	 (yellow)	Configuration warning	9
<p><b>Cause:</b> Safety validation is not complete.</p> <p><b>Measure:</b> Acknowledge safety event in the Functional Safety menu and repeat safety commissioning.</p>					
	Out of specification	3		Process value warning	10
<p><b>Cause:</b> Deviations from permissible ambient or process conditions detected by the device (by means of self-monitoring or based on warnings/errors in the device) indicate that the measured value is unreliable or that deviations from the set value in the actuators are most likely greater than anticipated under normal operating conditions.</p> <p>Process or ambient conditions can damage the device or result in unreliable results.</p> <p><b>Measure:</b> Check ambient temperature or process conditions. If possible, install device at different location.</p>					
No symbol is displayed				Process value tolerance	11
<p><b>Cause:</b> At least one process value violates one of the process tolerance limits set in the device parameters.</p> <p><b>Measure:</b> Check the parameter settings for limits for this application.</p>					
No symbol is displayed			No symbol is displayed	Configuration changed	12
<p><b>Cause:</b>The device configuration has changed due to a work process.</p> <p><b>Measure:</b> Reset configuration bit memory to delete the diagnostic message.</p>					
No symbol is displayed	Good – OK		No symbol is displayed	No assignment	13
<p><b>Cause:</b> Device state ok. No errors from active diagnostics.</p> <p><b>Measure:</b> No action required.</p>					







\* The smallest number indicates the highest level of error severity.



















\*\* In SIMATIC PDM, the Siemens standard symbol as well as the corresponding NAI symbol is displayed (by the device display).

## 12.2 Diagnostic messages









The following table shows the IDs of diagnostic messages and possible causes and instructions for corrective actions.



















Depending on the communication and configuration of your device, certain diagnostic messages are not applicable.

ID	Symbols	Message	Cause/Remedy
A0		Event counter 1 Number overruns above threshold Maintenance alarm	The number of overruns of the process value (set in parameters "Upper limit" and "Monitored value") has reached the threshold. Reset and acknowledge event counter. Check process conditions. Check limit monitoring and event counter settings.
A1		Event counter 1 Number underruns above threshold Process value alarm	The number of underruns of the process value (set in parameters "Lower limit" and "Monitored value") has reached the threshold. Reset and acknowledge event counter. Check process conditions. Check limit monitoring and event counter settings.
A2		Event counter 1 Number underruns above threshold Maintenance required	The number of underruns of the process value (set in parameters "Lower limit" and "Monitored value") has reached the threshold. Reset and acknowledge event counter. Check process conditions. Check limit monitoring and event counter settings.
A3		Event counter 1 Number underruns above threshold Maintenance alarm	The number of underruns of the process value (set in parameters "Lower limit" and "Monitored value") has reached the threshold. Reset and acknowledge event counter. Check process conditions. Check limit monitoring and event counter settings.
A4		Event counter 2 Number overruns above threshold Process value alarm	The number of overruns of the process value (set in parameters "Upper limit" and "Monitored value") has reached the threshold. Reset and acknowledge event counter. Check process conditions. Check limit monitoring and event counter settings.
A6		Event counter 2 Number overruns above threshold Maintenance required	The number of overruns of the process value (set in parameters "Upper limit" and "Monitored value") has reached the threshold. Reset and acknowledge event counter. Check process conditions. Check limit monitoring and event counter settings.
A7		Event counter 2 Number overruns above threshold Maintenance alarm	The number of overruns of the process value (set in parameters "Upper limit" and "Monitored value") has reached the threshold. Reset and acknowledge event counter. Check process conditions. Check limit monitoring and event counter settings.











ID	Symbols	Message	Cause/Remedy
A8	 	Event counter 2 Number underruns above threshold Process value alarm	The number of underruns of the process value (set in parameters "Lower limit" and "Monitored value") has reached the threshold. Reset and acknowledge event counter. Check process conditions. Check limit monitoring and event counter settings.
A9	 	Event counter 2 Number underruns above threshold Maintenance required	The number of underruns of the process value (set in parameters "Lower limit" and "Monitored value") has reached the threshold. Reset and acknowledge event counter. Check process conditions. Check limit monitoring and event counter settings.
AA	 	Device lifetime: Maintenance demanded	Forthcoming end of configured device's lifetime. Maintenance is strongly recommended as soon as possible.
Ab	 	Device lifetime: Maintenance required	Forthcoming end of configured device's lifetime. Maintenance of device should be planned.
AC	 	Sensor lifetime: Maintenance demanded	Forthcoming end of configured sensor's lifetime. Maintenance is strongly recommended as soon as possible.
Ad	 	Sensor lifetime: Maintenance required	Forthcoming end of configured sensor's lifetime. Maintenance of device should be planned.
AE	 	Service: Maintenance demanded	Forthcoming end of the configured service interval. Maintenance is strongly recommended as soon as possible.
AF	 	Service: Maintenance required	Forthcoming end of the configured service interval. Maintenance of device should be planned.
AG	 	Calibration: Maintenance demanded	Forthcoming end of the calibration interval. Maintenance is strongly recommended as soon as possible.







12.2 Diagnostic messages

ID	Symbols	Message	Cause/Remedy
AH		Calibration: Maintenance required	Forthcoming end of the calibration interval. Maintenance of device should be planned.
AJ		Limit monitoring 1 Above limit Process value alarm	Monitored value is above limit (set in parameter "Upper limit").
AL		Limit monitoring 1 Below limit Process value alarm	Monitored value is below limit (set in parameter "Lower limit").
An		Limit monitoring 2 Above limit Process value alarm	Monitored value is above limit (set in parameter "Upper limit").
Ao		Limit monitoring 2 Below limit Process value alarm	Monitored value is below limit (set in parameter "Lower limit").
AU		Event counter 1 Number overruns above threshold Process value alarm	The number of overruns of the process value (set in parameters "Upper limit" and "Monitored value") has reached the threshold. Reset and acknowledge event counter. Check process conditions. Check limit monitoring and event counter settings.
AY		Event counter 1 Number overruns above threshold Maintenance required	The number of overruns of the process value (set in parameters "Upper limit" and "Monitored value") has reached the threshold. Reset and acknowledge event counter. Check process conditions. Check limit monitoring and event counter settings.
bE		Out of service Maintenance alarm	The output signal does not represent the process value. The device mode is set to "Out of service". Repair required. Contact Technical Support.
bL		Device restart due to unexpected program error Maintenance alarm	Watchdog function has detected an internal device error. Restart the device. If the problem persists, contact Technical Support.

ID	Symbols	Message	Cause/Remedy
bn	 	Alarm sensor limit exceeded Process value alarm	Process value has reached the sensor limit. Review process conditions versus product specifications.
bS	 	Event counter 2 Number underruns above threshold Maintenance alarm	The number of underruns of the process value (set in parameters "Lower limit" and "Monitored value") has reached the threshold. Reset and acknowledge event counter. Check process conditions. Check limit monitoring and event counter settings.
CA	 	Simulation mode	The device is in simulation mode and one or more of its device variables are not representative of the process. Disable the simulation to return to normal operation.
Cb	 	Diagnostics simulated Simulation mode	The device is in simulation mode. Disable the simulation to return to normal operation.
Co	 	Loop current fixed Manual operation	The loop current is being held at a fixed value and is not responding to process variations. Enter the loop current output value for simulation. Disable the simulation to return to normal operation.
CP	 	Loop current in saturation Process value warning	The loop current has reached its upper (or lower) saturation limit and cannot increase (or decrease) any further. Adjust loop current scaling.
CU	 	PV status: uncertain Process value alarm	The value is outside of the physical sensor range. Accuracy may decrease. Check for changes in process conditions or obstructions in vessel.
CY	 	PV status: bad Maintenance alarm	The measured value is 10% higher than the physical sensor range. Review process conditions versus product specifications. Use a device that fulfills your process conditions.
Fb	 	Supply voltage below limit. Maintenance demanded	The supply voltage is too low. Make sure input voltage is within product specification.

12.2 Diagnostic messages

ID	Symbols	Message	Cause/Remedy
FC		Supply voltage above limit Maintenance alarm	The supply voltage is too high. Make sure input voltage is within product specification.
FE		Loop current read back error Maintenance demanded	The loop current does not correspond to the expected value. Check DAC trim settings. Restore to factory DAC calibration. If the problem persists, contact Technical Support.
FJ		Process conditions outside the specification Process value warning	Uncertain values due to process conditions. Check installation for abnormal operating conditions.
Fn		Connection error to sensor electronics. Maintenance alarm	Potential product damage. Restart the device. If error continues, sensor electronics may have a defect. Repair required. Contact Technical Support.
Fo		Sensor break Maintenance alarm	Potential product damage. Sensor has malfunctioned. A replacement of sensor is recommended. Contact Technical Support.
Fr		Internal power supply is out of allowable range. Process value warning	A replacement of the device is recommended. Contact Technical Support.
FS		Electronics defect Maintenance alarm	Defect of device electronics. A replacement of the device is recommended. Contact Technical Support.
L		-	The device is write-protected by a jumper.
LA		-	Incorrect PIN entered 3 times. Try again in some minutes.
Lb	 (yellow)	User PIN unchanged Configuration warning	The default user PIN is being used. Enter a new user PIN to optimally protect the device.

ID	Symbols	Message	Cause/Remedy
LL		-	Button lock is enabled.
LP		-	Parameters and device functions are write-protected with a user PIN.
SA		Non-volatile memory check failure Maintenance alarm	Device electronics error. Restart the device. If error continues, device electronics may have a defect. Repair is required. Contact Technical Support.
Sb		Volatile memory check failure Maintenance alarm	Device electronics error. Restart the device. If error continues, device electronics may have a defect. Repair is required. Contact Technical Support.
SC	 (red)	Invalid device configuration Configuration error	One or more of parameters are set to invalid values. Review configuration values and adjust as necessary.
St	 (yellow)	Safety validation mode Configuration warning	Device is in safety validation mode. Complete the functional test and confirm that it was successful in the Functional Safety wizard.
SU		Safety critical device error Maintenance alarm	Acknowledge the error in menu "Functional Safety". If the device does not display an error, repeat the safety start up. If the problem persists, contact Technical Support.

### See also

Acknowledging safety-related errors (Page 178)

















## 12.3 Alarm and warning

Depending on the configuration and device mode, the diagnostic messages on the device can be different for the same events.

For devices with functional safety, use the parameter "Overload behavior" [36] to set whether an alarm or warning is output.

For specific events, the selected parameter setting in the "Functional Safety enabled" device mode has no effect on the type of the diagnostic message.

### Events and diagnostic messages according to NAMUR NE 107

Cause	Device without functional safety or functional safety is disabled		Device in "Functional Safety enabled" device mode			
			"Overload behavior" [36] parameter: Warning		"Overload behavior" [36] parameter: Alarm	
Electronics temperature outside specification	Alarm		Alarm		Alarm	
Sensor temperature outside specification	Alarm		Alarm		Alarm	
Lower saturation limit reached	Warning		Warning		Warning	
Upper saturation limit reached	Warning		Warning		Warning	
Sensor break	Alarm		Alarm		Alarm	
Electronics defect	Alarm		Alarm		Alarm	
Supply voltage too low	Warning		Warning		Warning	
Loop current read back error	Warning		Alarm		Alarm	
Process pressure outside the nominal measuring range (> 10%)	Warning		Warning		Alarm	

You can find information on how to set the "Overload behavior" [36] parameter in the following section:

Overload behavior [36] (Page 147)

Information on the diagnostics process of the device in the "Functional Safety enabled" device mode is available in the section:

Device mode "Functional Safety enabled" (Page 169)

## 12.4 Troubleshooting

Symptom	Cause of error	Remedy
Display empty or shows "INIT"	No or incorrect supply voltage	Check the voltage at the terminals, the connections and the wiring.
Display shows "#####" instead of the current measured value	Value too large to appear on the display	Adjust the unit so that a lower value can be displayed.



## 12.5 Troubleshooting Functional Security

Below you can find explanations on how to correct problems when enabling Functional Safety.

Information message on the display	Cause of error	Remedy
INVALID CFG ACCES	Write protection via user PIN disabled.	Activate write protection via the user PIN. Enable user PIN (Page 140)
INVALID CFG TRNFK	Wrong characteristic curves selected.	Select one of the following characteristic curves: <ul style="list-style-type: none"> <li>• Linear, proportional to pressure (PRESS).</li> <li>• Linear, proportional to level (LEVEL).</li> <li>• Proportional to flow rate, two-step linear up to the application point (VSLN2 or MSLN2).</li> </ul>
INVALID CFG LOOP	Loop current fixed. Loop test or multidrop mode are enabled.	To return to normal operation, disable the loop test or multidrop mode. Loop test [31] (Page 143)
INVALID CFG SIMUL	Device in simulation mode: Pressure measured value is simulated.	Disable simulation to return to normal operation. Simulate constant pressure values (Page 150)
INVALID CFG STSIM	Device in simulation mode: Diagnostics are simulated.	Disable simulation to return to normal operation. Simulate diagnostics (Page 151)
INVALID CFG PARAM	Factory settings for Functional Safety are faulty.	Replace the device.



## Technical data

### 13.1 Input

#### 13.1.1 Gauge pressure

<b>Gauge pressure input</b>			
Measurand	Gauge pressure		
Measuring span (continuously adjustable) or measuring range, max. operating pressure (in accordance with 2014/68/EU Pressure Equipment Directive) and max. test pressure (in accordance with DIN 16086) (for oxygen measurement, max. 100 bar and 60 °C ambient temperature/ process temperature)	Measuring span <sup>1)</sup>	Maximum permissible operating pressure MAWP (PS)	Maximum test pressure
	8.3 ... 250 mbar	4 bar	6 bar
	0.83 ... 25 kPa	0.4 MPa	0.6 MPa
	0.12 ... 3.6 psi	58 psi	87 psi
	0.01 ... 1 bar	6 bar	9 bar
	1 ... 100 kPa	0.6 MPa	0.9 MPa
	0.15 ... 14.5 psi	87 psi	130 psi
	0.04 ... 4 bar	20 bar	30 bar
	4 ... 400 kPa	2 MPa	3 MPa
	0.58 ... 58 psi	290 psi	435 psi
	0.16 ... 16 bar	45 bar	70 bar
	0.016 ... 1.6 MPa	4.5 MPa	7 MPa
	2.3 ... 232 psi	652 psi	1015 psi
	0.63 ... 63 bar	80 bar	120 bar
	0.063 ... 6.3 MPa	8 MPa	12 MPa
	9.1 ... 914 psi	1160 psi	1740 psi
	1.6 ... 160 bar	240 bar	360 bar
	0.16 ... 16 MPa	24 MPa	36 MPa
	23 ... 2321 psi	3480 psi	5221 psi
	4 ... 400 bar	400 bar	600 bar
0.4 ... 40 MPa	40 MPa	60 MPa	
58 ... 5802 psi	5802 psi	8702 psi	
7 ... 700 bar	800 bar	800 bar	
0.7 ... 70 MPa	80 MPa	80 MPa	
102 ... 10153 psi	11603 psi	11603 psi	
<b>Gauge pressure measuring limits</b>			
Low measuring limit <sup>2)</sup>			
<ul style="list-style-type: none"> <li>Measuring cell with silicone oil filling 30 mbar a/3 kPa a/0.44 psi a</li> </ul>			

13.1 Input

Gauge pressure measuring limits	
• Measuring cell with inert oil	30 mbar a/3 kPa a/0.44 psi a
• Measuring cell with FDA-compliant oil	100 mbar a/10 kPa a/1.45 psi a
Upper measuring limit	100% of max. range (for oxygen measurement: max. 100 bar/10 MPa/1450 psi and 60 °C ambient temperature/medium temperature)
Lower range value	Between the measuring limits (continuously adjustable)

<sup>1)</sup> For devices with functional safety, the minimum permissible measuring span is limited by the turndown. Therefore, ensure that the configured turndown is no higher than 5:1.

<sup>2)</sup> For 250 mbar/25 kPa/3.6 psi measuring cells, the low measuring limit is 750 mbar a/75 kPa a/10.8 psi a. The measuring cell is vacuum-tight down to 30 mbar a/3 kPa a/0.44 psi a.

13.1.2 Gauge pressure with front-flush diaphragm

Gauge pressure input with front-flush diaphragm			
Measurand	Gauge pressure		
Measuring span (continuously adjustable) or measuring range, max. operating pressure and max. test pressure	Measuring span <sup>1)</sup>	Maximum permissible operating pressure MAWP (PS)	Maximum test pressure
	0.01 ... 1 bar	Refer to the information on the nameplate of the pressure transmitter and the data on the mounting flange <sup>2)</sup>	
	1 ... 100 kPa		
	0.15 ... 14.5 psi		
	0.04 ... 4 bar		
	4 ... 400 kPa		
	0.58 ... 58 psi		
	0.16 ... 16 bar		
	0.016 ... 1.6 MPa		
	2.3 ... 232 psi		
0.6 ... 63 bar			
0.063 ... 6.3 MPa			
9.1 ... 914 psi			

<sup>1)</sup> For devices with functional safety, the minimum permissible measuring span is limited by the turndown. Therefore, ensure that the configured turndown is no higher than 5:1.

<sup>2)</sup> The MAWP value of the pressure transmitter can be lower than the PN value of the mounting flange and vice versa. To determine the maximum permissible operating pressure and the maximum permissible test pressure, use the lowest value as reference.

Gauge pressure measuring limits with front-flush diaphragm	
Lower measuring limit	
• Measuring cell with silicone oil filling	100 mbar a/10 kPa a/1.45 psi a
• Measuring cell with inert oil	100 mbar a/10 kPa a/1.45 psi a

**Gauge pressure measuring limits with front-flush diaphragm**

• Measuring cell with FDA-compliant oil	100 mbar a/10 kPa a/1.45 psi a
Upper measuring limit	100% of max. range

**13.1.3 Gauge pressure from the differential pressure series**

**Gauge pressure input from the differential pressure series**

Measurand	Gauge pressure and differential pressure		
Measuring span (continuously adjustable) and maximum operating pressure (according to 2014/68/EU Pressure Equipment Directive)	Measuring span <sup>1)</sup>	Maximum permissible operating pressure MAWP (PS)	Max. permissible test pressure
		1 ... 20 mbar	160 bar
0.1 ... 2 kPa		16 MPa	24 MPa
0.4015 ... 8.031 inH <sub>2</sub> O		2320 psi	3480 psi
	1 ... 60 mbar	160 bar	240 bar
	0.1 ... 6 kPa	16 MPa	24 MPa
	0.4015 ... 24.09 inH <sub>2</sub> O	2320 psi	3480 psi
	2.5 ... 250 mbar	160 bar	240 bar
	0.2 ... 25 kPa	16 MPa	24 MPa
	1.004 ... 100.4 inH <sub>2</sub> O	2320 psi	3480 psi
	6 ... 600 mbar	160 bar	240 bar
	0.6 ... 60 kPa	16 MPa	24 MPa
	2.409 ... 240.9 inH <sub>2</sub> O	2320 psi	3480 psi
	16 ... 1600 mbar	160 bar	240 bar
	1.6 ... 160 kPa	16 MPa	24 MPa
	6.424 ... 642.4 inH <sub>2</sub> O	2320 psi	3480 psi
	50 ... 5000 mbar	160 bar	240 bar
	5 ... 500 kPa	16 MPa	24 MPa
	20.08 ... 2008 inH <sub>2</sub> O	2320 psi	3480 psi
	0.3 ... 30 bar	160 bar	240 bar
	0.03 ... 3 MPa	16 MPa	24 MPa
	4.35 ... 435 psi	2320 psi	3480 psi
	8 ... 160 bar	160 bar	240 bar
	0.8 ... 16 MPa	16 MPa	24 MPa
	116 ... 2320 psi	2320 psi	3480 psi

<sup>1)</sup> For devices with functional safety, the minimum permissible measuring span is limited by the turndown. Therefore, ensure that the configured turndown is no higher than 5:1.

**Gauge pressure measuring limits from differential pressure series**

Lower measuring limit

• Measuring cell with silicone oil filling	30 mbar a/3 kPa a/0.44 psi a
--	------------------------------

13.1 Input

<b>Gauge pressure measuring limits from differential pressure series</b>	
• Measuring cell with inert oil	30 mbar a/3 kPa a/0.44 psi a
• Measuring cell with FDA-compliant oil	100 mbar a/10 kPa a/1.45 psi a
Upper measuring limit	100% of max. range (for oxygen measurement: max. 100 bar/10 MPa/1450 psi and 60 °C ambient temperature/medium temperature)
Lower range value	Between the measuring limits (continuously adjustable)

**13.1.4 Absolute pressure from the gauge pressure series**

<b>Absolute pressure input from the gauge pressure series</b>			
Measurand	Absolute pressure		
Measuring span (continuously adjustable) or measuring range, max. operating pressure (in accordance with 2014/68/EU Pressure Equipment Directive) and max. test pressure (in accordance with DIN 16086)	Measuring span <sup>1)</sup>	Maximum permissible operating pressure MAWP (PS)	Maximum test pressure
	8.3 ... 250 mbar a	4 bar a	6 bar a
	0.83 ... 25 kPa a	0.4 MPa a	0.6 MPa a
	3 ... 100 inH <sub>2</sub> O a	58 psi a	87 psi a
	43 ... 1300 mbar a	6.6 bar a	10 bar a
	4.3 ... 130 kPa a	0.66 MPa a	1 MPa a
	17 ... 525 inH <sub>2</sub> O a	95 psi a	145 psi a
	166 ... 5000 mbar a	20 bar a	30 bar a
	16.6 ... 500 kPa a	2 MPa a	3 MPa a
	2.41 ... 72.5 psi a	290 psi a	435 psi a
	1 ... 30 bar a	65 bar a	100 bar a
	0.1 ... 3 MPa a	6.5 MPa a	10 MPa a
	14.5 ... 435 psi a	942 psi a	1450 psi a
	5.3 ... 160 bar a	240 bar a	380 bar a
	0.53 ... 16 MPa a	24 MPa a	38 MPa a
	77 ... 2321 psi a	3480 psi a	5511 psi a
	13.3 ... 400 bar a	400 bar a	600 bar a
	1.3 ... 40 MPa a	40 MPa a	60 MPa a
	192 ... 5801 psi a	5801 psi a	8702 psi a
	23.3 ... 700 bar a	800 bar a	800 bar a
2.3 ... 70 MPa a	80 MPa a	80 MPa a	
337 ... 10152 psi a	11603 psi a	11603 psi a	

<sup>1)</sup> For devices with functional safety, the minimum permissible measuring span is limited by the turndown. Therefore, ensure that the configured turndown is no higher than 5:1.

<b>Absolute pressure measuring limits from gauge pressure series</b>	
Lower measuring limit	
• Measuring cell with silicone oil filling	0 mbar a/kPa a/psi a

**Absolute pressure measuring limits from gauge pressure series**

<ul style="list-style-type: none"> <li>Measuring cell with inert oil</li> </ul>	
For process temperature -20 °C < $\vartheta$ ≤ 60 °C (-4 °F < $\vartheta$ ≤ +140 °F)	30 mbar a/3 kPa a/0.44 psi a
For process temperature 60 °C < $\vartheta$ ≤ 100 °C (max. 85 °C for measuring cell 30 bar) (140 °F < $\vartheta$ ≤ 212 °F (max. 185 °F for measuring cell 435 psi))	30 mbar a + 20 mbar a • ( $\vartheta$ - 60 °C)/°C 3 kPa a + 2 kPa a • ( $\vartheta$ - 60 °C)/°C 0.44 psi a + 0.29 psi a • ( $\vartheta$ - 140 °F)/°F
Upper measuring limit	100% of max. range (for oxygen measurement: max. 100 bar/10 MPa/1450 psi and 60 °C ambient temperature/medium temperature)
Lower range value	Between the measuring limits (continuously adjustable)

**13.1.5 Absolute pressure with front-flush diaphragm**

**Absolute pressure with front-flush diaphragm**

Measurand	Absolute pressure		
Measuring span (continuously adjustable) or measuring range, max. operating pressure and max. test pressure	Measuring span <sup>1)</sup>	Maximum permissible operating pressure MAWP (PS)	Maximum test pressure
	43 ... 1300 mbar a	Refer to the information on the nameplate of the pressure transmitter and the data on the mounting flange <sup>2)</sup>	
	4.3 ... 130 kPa a		
	17 ... 525 inH <sub>2</sub> O a		
	166 ... 5000 mbar a		
	16.6 ... 500 kPa a		
	2.41 ... 72.5 psi a		
	1 ... 30 bar a		
0.1 ... 3 MPa a			
14.5 ... 435 psi a	Depending on the process connection, the measuring span may differ from these values		

<sup>1)</sup> For devices with functional safety, the minimum permissible measuring span is limited by the turndown. Therefore, ensure that the configured turndown is no higher than 5:1.

<sup>2)</sup> The MAWP value of the pressure transmitter can be lower than the PN value of the mounting flange and vice versa. To determine the maximum permissible operating pressure and the maximum permissible test pressure, use the lowest value as reference.

**Absolute pressure measuring limits with front-flush diaphragm**

Lower measuring limit	
<ul style="list-style-type: none"> <li>Measuring cell with silicone oil filling</li> </ul>	0 mbar a/kPa a/psi a
Upper measuring limit	100% of max. range
Lower range value	Between the measuring limits (continuously adjustable)

### 13.1.6 Absolute pressure from the differential pressure series

Absolute pressure input from the differential pressure series			
Measurand	Absolute pressure		
Measuring span (continuously adjustable) and maximum operating pressure (according to 2014/68/EU Pressure Equipment Directive)	Measuring span <sup>1)</sup>	Maximum permissible operating pressure MAWP (PS)	Max. permissible test pressure
	8.3 ... 250 mbar a	160 bar a	240 bar a
	0.83 ... 25 kPa a	16 MPa a	24 MPa a
	3 ... 100 inH <sub>2</sub> O a	2320 psi a	3480 psi a
	43 ... 1300 mbar a	160 bar a	240 bar a
	4.3 ... 130 kPa a	16 MPa a	24 MPa a
	17 ... 525 inH <sub>2</sub> O a	2320 psi a	3480 psi a
	166 ... 5000 mbar a	160 bar a	240 bar a
	16.6 ... 500 kPa a	16 MPa a	24 MPa a
	2.41 ... 72.5 psi a	2320 psi a	3480 psi a
	1 ... 30 bar a	160 bar a	240 bar a
	0.1 ... 3 MPa a	16 MPa a	24 MPa a
	14.5 ... 435 psi a	2320 psi a	3480 psi a
	8 ... 160 bar a	160 bar a	160 bar a
	0.8 ... 16 MPa a	16 MPa a	16 MPa a
	116 ... 2320 psi a	2320 psi a	2320 psi a

<sup>1)</sup> For devices with functional safety, the minimum permissible measuring span is limited by the turndown. Therefore, ensure that the configured turndown is no higher than 5:1.

#### Absolute pressure measuring limits from differential pressure series

Lower measuring limit	
• Measuring cell with silicone oil filling	0 mbar a/kPa a/psi a
• Measuring cell with inert liquid	
For process temperature $-20\text{ °C} < \vartheta \leq 60\text{ °C}$ ( $-4\text{ °F} < \vartheta \leq +140\text{ °F}$ )	30 mbar a/3 kPa a/0.44 psi a
For process temperature $60\text{ °C} < \vartheta \leq 100\text{ °C}$ (max. 85 °C for measuring cell 30 bar) ( $140\text{ °F} < \vartheta \leq 212\text{ °F}$ (max. 185 °F for measuring cell 435 psi))	30 mbar a + 20 mbar a • $(\vartheta - 60\text{ °C})/\text{°C}$ 3 kPa a + 2 kPa a • $(\vartheta - 60\text{ °C})/\text{°C}$ 0.44 psi a + 0.29 psi a • $(\vartheta - 140\text{ °F})/\text{°F}$
Upper measuring limit	100% of max. range (for oxygen measurement: max. 100 bar/10 MPa/1450 psi and 60 °C ambient temperature/medium temperature)
Lower range value	Between the measuring limits (continuously adjustable)



### 13.1.7 Differential pressure and flow

Differential pressure and flow rate input, MAWP 160 bar (2320 psi)			
Measurand	Differential pressure and flow		
Measuring span (continuously adjustable) and maximum operating pressure (according to 2014/68/EU Pressure Equipment Directive)	Measuring span <sup>1)</sup>	Maximum permissible operating pressure MAWP (PS)	Max. permissible test pressure
	1 ... 20 mbar	0.1 ... 2 kPa	16 MPa
0.4015 ... 8.031 inH <sub>2</sub> O		2320 psi	3480 psi
1 ... 60 mbar		160 bar	240 bar
0.1 ... 6 kPa	0.4015 ... 24.09 inH <sub>2</sub> O	2320 psi	3480 psi
	2.5 ... 250 mbar	160 bar	240 bar
	0.2 ... 25 kPa	16 MPa	24 MPa
1.004 ... 100.4 inH <sub>2</sub> O	6 ... 600 mbar	160 bar	240 bar
	0.6 ... 60 kPa	16 MPa	24 MPa
	2.409 ... 240.9 inH <sub>2</sub> O	2320 psi	3480 psi
16 ... 1600 mbar	1.6 ... 160 kPa	16 MPa	24 MPa
	6.424 ... 642.4 inH <sub>2</sub> O	2320 psi	3480 psi
	50 ... 5000 mbar	160 bar	240 bar
5 ... 500 kPa	5 ... 500 kPa	16 MPa	24 MPa
	20.08 ... 2008 inH <sub>2</sub> O	2320 psi	3480 psi
	0.3 ... 30 bar	160 bar	240 bar
0.03 ... 3 MPa	0.03 ... 3 MPa	16 MPa	24 MPa
	4.35 ... 435 psi	2320 psi	3480 psi
	8 ... 160 bar	160 bar	240 bar
0.8 ... 16 MPa	0.8 ... 16 MPa	16 MPa	24 MPa
	116 ... 2320 psi	2320 psi	3480 psi

13.1 Input

<sup>1)</sup> For devices with functional safety, the minimum permissible measuring span is limited by the turndown. Therefore, ensure that the configured turndown is no higher than 5:1.

<b>Differential pressure and flow rate input, MAWP 420 bar (6092 psi)</b>			
Measurand	Differential pressure and flow		
Measuring span (continuously adjustable) or measuring range and maximum operating pressure (according to 2014/68/EU Pressure Equipment Directive)	Measuring span <sup>1)</sup>	Maximum operating pressure MAWP (PS)	Max. permissible test pressure
	2.5 ... 250 mbar	420 bar	630 bar
	0.25 ... 25 kPa	42 MPa	63 MPa
	1.004 ... 100.4 inH <sub>2</sub> O	6091 psi	9137 psi
	6 ... 600 mbar	420 bar	630 bar
	0.6 ... 60 kPa	42 MPa	63 MPa
	2.409 ... 240.9 inH <sub>2</sub> O	6091 psi	9137 psi
	16 ... 1600 mbar	420 bar	630 bar
	1.6 ... 160 kPa	42 MPa	63 MPa
	6.424 ... 642.4 inH <sub>2</sub> O	6091 psi	9137 psi
	50 ... 5000 mbar	420 bar	630 bar
	5 ... 500 kPa	42 MPa	63 MPa
	20.08 ... 2008 inH <sub>2</sub> O	6091 psi	9137 psi
	0.3 ... 30 bar	420 bar	630 bar
	0.03 ... 3 MPa	42 MPa	63 MPa
4.35 ... 435 psi	6091 psi	9137 psi	

<sup>1)</sup> For devices with functional safety, the minimum permissible measuring span is limited by the turndown. Therefore, ensure that the configured turndown is no higher than 5:1.

<b>Differential pressure and flow measuring limits</b>		
<b>Lower measuring limit</b>		
• Measuring cell with silicone oil filling		
All measuring cells	-100% of maximum measuring range or 30 mbar a /3 kPa a /0.44 psi a	
Measuring cell 160 bar/ 0.16 MPa/ 2320 psi	-25% of maximum measuring range or 30 mbar a /3 kPa a /0.44 psi a	
• Measuring cell with inert oil		
	For process temperature -20 °C < θ ≤ 60 °C (-4 °F < θ ≤ +140 °F)	-100% of maximum measuring range or 30 mbar a /3 kPa a /0.44 psi a
	For medium temperature 60 °C < θ ≤ 100 °C (max. 85 °C for measuring cell 30 bar with MAWP 420 bar) (140 °F < θ ≤ 212 °F (max. 185 °F for measuring cell 435 psi))	-100% of maximum measuring range or 30 mbar a /3 kPa a /0.44 psi a 30 mbar a + 20 mbar a • (θ - 60 °C)/°C 3 kPa a + 2 kPa a • (θ - 60 °C)/°C 0.44 psi a + 0.29 psi a • (θ - 140 °F)/°F
• Measuring cell with FDA-compliant oil	For process temperature -10 °C < θ ≤ 100 °C (-14 °F < θ ≤ +212 °F)	-100% of maximum measuring range or 100 mbar a /10 kPa a / 14.5 psi a.

**Differential pressure and flow measuring limits**

Upper measuring limit	100% of max. range (for oxygen measurement: max. 100 bar/10 MPa/1450 psi and 60 °C ambient temperature/medium temperature)
Lower range value	Between the measuring limits (continuously adjustable)

**13.1.8 Level**

**Level input**

Measurand	Level	Maximum permissible operating pressure MAWP (PS)	Max. permissible test pressure
Measuring span (continuously adjustable) and maximum operating pressure (according to 2014/68/EU Pressure Equipment Directive)	Measuring span <sup>1)</sup>	See mounting flange	
	25 ... 250 mbar		
	2.5 ... 25 kPa		
	10 ... 100 inH <sub>2</sub> O		
	25 ... 600 mbar		
	2.5 ... 60 kPa		
	10 ... 240 inH <sub>2</sub> O		
	53 ... 1600 mbar		
	5.3 ... 160 kPa		
	21 ... 640 inH <sub>2</sub> O		
166 ... 5000 mbar			
16.6 ... 500 kPa			
2.41 ... 72.5 psi			

<sup>1)</sup> For devices with functional safety, the minimum permissible measuring span is limited by the turndown. Therefore, ensure that the configured turndown is no higher than 5:1.

**Level measuring limits**

Lower measuring limit	
Measuring cell with silicone oil filling	-100% of max. measuring range or 30 mbar a/3 kPa a/0.44 psi a depending on the mounting flange
Measuring cell with inert oil	-100% of max. measuring range or 30 mbar a/3 kPa a/0.44 psi a depending on the mounting flange
Measuring cell with FDA-compliant oil	-100% of maximum measuring range or 100 mbar a /10 kPa a /1.45 psi a
Upper measuring limit	100% of max. range
Lower range value	Between the measuring limits (continuously adjustable)

## 13.2 Measuring accuracy of SITRANS P320

### 13.2.1 Reference conditions

- According to IEC 62828-1
- Rising characteristic curve
- Lower range value 0 bar/kPa/psi
- Seal diaphragm stainless steel
- Measuring cell with silicone oil filling
- Room temperature 25 °C (77 °F)

### 13.2.2 Effect of auxiliary power supply

0.005% per 1 V (in percent per change in voltage)

### 13.2.3 Gauge pressure

#### Conformity error at limit point setting, including hysteresis and repeatability - gauge pressure

Measuring span ratio r (turndown)	r = max. measuring span/set measuring span and nominal measuring range	
• Linear characteristic curve	$r \leq 1.25$	$1.25 < r \leq 30$
250 mbar/25 kPa/3.6 psi	$\leq 0.075\%$	$\leq (0.008 \cdot r + 0.065)\%$
• Linear characteristic curve	$r \leq 5$	$5 < r \leq 100$
1 bar/100 kPa/14.5 psi	$\leq 0.065\%$	$\leq (0.004 \cdot r + 0.045)\%$
4 bar/400 kPa/58 psi		
16 bar/1.6 MPa/232 psi		
63 bar/6.3 MPa/914 psi		
160 bar/16 MPa/2321 psi		
• Linear characteristic curve	$r \leq 5$	$5 < r \leq 100$
400 bar/40 MPa/5802 psi	$\leq 0.075\%$	$0.005 \cdot r + 0.05$
700 bar/70 MPa/10152 psi		

#### Effect of ambient temperature - gauge pressure

In percent per 28 °C (50 °F)	
250 mbar/25 kPa/3.6 psi	$\leq (0.16 \cdot r + 0.1)\%$
1 bar/100 kPa/14.5 psi	$\leq (0.05 \cdot r + 0.1)\%$

**Effect of ambient temperature - gauge pressure**

4 bar/400 kPa/58 psi	$\leq (0.025 \cdot r + 0.125)\%$
16 bar/1.6 MPa/232 psi	
63 bar/6.3 MPa/914 psi	
160 bar/16 MPa/2321 psi	
400 bar/40 MPa/5802 psi	
700 bar/70 MPa/10152 psi	$\leq (0.08 \cdot r + 0.16)\%$

**Long-term stability at  $\pm 30$  °C ( $\pm 54$  °F) - gauge pressure**

250 mbar/25 kPa/3.6 psi	Per year $\leq (0.25 \cdot r)\%$
1 bar/100 kPa/14.5 psi	In 5 years $\leq (0.25 \cdot r)\%$ In 10 years $\leq (0.35 \cdot r)\%$
4 bar/400 kPa/58 psi	In 5 years $\leq (0.125 \cdot r)\%$
16 bar/1.6 MPa/232 psi	In 10 years $\leq (0.15 \cdot r)\%$
63 bar/6.3 MPa/914 psi	
160 bar/16 MPa/2321 psi	
400 bar/40 MPa/5802 psi	
700 bar/70 MPa/10152 psi	In 5 years $\leq (0.25 \cdot r)\%$ In 10 years $\leq (0.35 \cdot r)\%$

**Step response time  $T_{63}$  (without electrical damping) - gauge pressure**

Approx. 0.105 s

**Effect of mounting position - gauge pressure**

$\leq 0.05$  mbar/0.005 kPa/0.000725 psi per 10° incline  
(correct the zero point with position error compensation)

### 13.2.4 Gauge pressure with front-flush diaphragm

**Conformity error at limit point setting, including hysteresis and repeatability - gauge pressure with front-flush diaphragm**

Measuring span ratio r (turndown)	r = max. measuring span/set measuring span and nominal measuring range	
<b>• Linear characteristic curve</b>	<b>r ≤ 5</b>	<b>5 &lt; r ≤ 100</b>
1 bar/100 kPa/14.5 psi	$\leq 0.075\%$	$\leq (0.005 \cdot r + 0.05)\%$
4 bar/400 kPa/58 psi		
16 bar/1.6 MPa/232 psi		
63 bar/6.3 MPa/914 psi		

13.2 Measuring accuracy of SITRANS P320

<b>Effect of ambient temperature - gauge pressure with front-flush diaphragm</b>	
In percent per 28 °C (50 °F)	
1 bar/100 kPa/14.5 psi	$\leq (0.08 \cdot r + 0.16)\%$
4 bar/400 kPa/58 psi	
16 bar/1.6 MPa/232 psi	
63 bar/6.3 MPa/914 psi	
<b>Long-term stability at ±30 °C (±54 °F) - gauge pressure with front-flush diaphragm</b>	
1 bar/100 kPa/14.5 psi	In 5 years $\leq (0.25 \cdot r)\%$
4 bar/400 kPa/58 psi	
16 bar/1.6 MPa/232 psi	In 5 years $\leq (0.125 \cdot r)\%$
63 bar/6.3 MPa/914 psi	
<b>Step response time <math>T_{63}</math> (without electrical damping) - gauge pressure with front-flush diaphragm</b>	
Approx. 0.105 s	
<b>Effect of mounting position - gauge pressure with front-flush diaphragm</b>	
$\leq 0.4$ mbar/0.04 kPa/0.006 psi per 10° incline (zero-point correction is possible with position error compensation)	

13.2.5 Gauge pressure from the differential pressure series

<b>Conformity error at limit point setting, including hysteresis and repeatability - gauge pressure from the differential pressure series</b>		
Measuring span ratio r (turndown)	r = max. measuring span/set measuring span and nominal measuring range	
<b>• Linear characteristic curve</b>	<b>r ≤ 5</b>	<b>5 &lt; r ≤ 20</b>
20 mbar/2 kPa/8.031 inH <sub>2</sub> O	$\leq 0.075\%$	$\leq (0.005 \cdot r + 0.05)\%$
<b>• Linear characteristic curve</b>	<b>r ≤ 5</b>	<b>5 &lt; r ≤ 60</b>
60 mbar/6 kPa/24.09 inH <sub>2</sub> O	$\leq 0.075\%$	$\leq (0.005 \cdot r + 0.05)\%$
<b>• Linear characteristic curve</b>	<b>r ≤ 5</b>	<b>5 &lt; r ≤ 100</b>
250 mbar/25 kPa/3.6 psi	$\leq 0.065\%$	$\leq (0.004 \cdot r + 0.045)\%$
600 mbar/60 kPa/240.9 inH <sub>2</sub> O		
1600 mbar/160 kPa/642.4 inH <sub>2</sub> O		
5000 mbar/500 kPa/2008 inH <sub>2</sub> O		
30 bar/3 MPa/435 psi		
<b>• Linear characteristic curve</b>	<b>r ≤ 5</b>	<b>5 &lt; r ≤ 20</b>
160 bar/16 MPa/2320 psi	$\leq 0.065\%$	$\leq (0.004 \cdot r + 0.045)\%$

---

**Effect of ambient temperature - gauge pressure from differential pressure series**

---

In percent per 28 °C (50 °F)

20 mbar/2 kPa/8.031 inH <sub>2</sub> O	$\leq (0.15 \cdot r + 0.1)\%$
60 mbar/6 kPa/24.09 inH <sub>2</sub> O	$\leq (0.075 \cdot r + 0.1)\%$
250 mbar/25 kPa/3.6 psi	$\leq (0.025 \cdot r + 0.125)\%$
600 mbar/60 kPa/240.9 inH <sub>2</sub> O	
1600 mbar/160 kPa/642.4 inH <sub>2</sub> O	
5000 mbar/500 kPa/2008 inH <sub>2</sub> O	
30 bar/3 MPa/435 psi	
160 bar/16 MPa/2320 psi	

---



---

**Long-term stability at ±30 °C (±54 °F) - gauge pressure from differential pressure series**

---

20 mbar/2 kPa/8.031 inH <sub>2</sub> O	Per year $\leq (0.2 \cdot r)\%$
60 mbar/6 kPa/24.09 inH <sub>2</sub> O	In 5 years $\leq (0.25 \cdot r)\%$
250 mbar/25 kPa/3.6 psi	In 5 years $\leq (0.125 \cdot r)\%$
600 mbar/60 kPa/240.9 inH <sub>2</sub> O	In 10 years $\leq (0.15 \cdot r)\%$
1600 mbar/160 kPa/642.4 inH <sub>2</sub> O	
5000 mbar/500 kPa/2008 inH <sub>2</sub> O	
30 bar/3 MPa/435 psi	
160 bar/16 MPa/2320 psi	

---



---

**Step response time  $T_{63}$  (without electrical damping) - gauge pressure from differential pressure series**

---

20 mbar/2 kPa/8.031 inH <sub>2</sub> O	Approx. 0.160 s
60 mbar/6 kPa/24.09 inH <sub>2</sub> O	Approx. 0.150 s
250 mbar/25 kPa/3.6 psi	Approx. 0.135 s
600 mbar/60 kPa/240.9 inH <sub>2</sub> O	
1600 mbar/160 kPa/642.4 inH <sub>2</sub> O	
5000 mbar/500 kPa/2008 inH <sub>2</sub> O	
30 bar/3 MPa/435 psi	
160 bar/16 MPa/2320 psi	

---



---

**Effect of mounting position - gauge pressure from differential pressure series**

---

$\leq 0.7$  mbar/0.07 kPa/0.01015266 psi per 10° incline  
(correct the zero point with position error compensation)

---

### 13.2.6 Absolute pressure from the gauge pressure series

Conformity error at limit point setting, including hysteresis and repeatability - Absolute pressure from gauge pressure series		
Measuring span ratio r (turndown)	r = max. measuring span/set measuring span and nominal measuring range	
• Linear characteristic curve	$r \leq 10$	$10 < r \leq 30$
All measuring cells	$\leq 0.1\%$	$\leq 0.2\%$

Effect of ambient temperature -- Absolute pressure from the gauge pressure series	
In percent per 28 °C (50 °F)	
250 mbar a/25 kPa a/3.6 psi a	$\leq (0.15 \cdot r + 0.1)$
1300 mbar a/130 kPa a/18.8 psi a	$\leq (0.08 \cdot r + 0.16)$
5 bar a/500 kPa a/72.5 psi a	
30 bar a/3000 kPa a/435 psi a	
160 bar a/16 MPa a/2321 psi a	
400 bar a/40 MPa a/5802 psi a	
700 bar a/70 MPa a/10152.6 psi a	

Long-term stability at ±30 °C (±54 °F) - Absolute pressure from gauge and differential pressure series	
In 5 years $\leq (0.25 \cdot r)\%$	

Step response time T <sub>63</sub> (without electrical damping) - Absolute pressure from gauge pressure series	
All measuring cells	Approx. 0.105 s

Effect of mounting position - Absolute pressure from the gauge pressure series	
In pressure per change of angle	
$\leq 0.05$ mbar/0.005 kPa/0.000725 psi per 10° incline	
(zero-point correction is possible using the zero point adjustment)	

### 13.2.7 Absolute pressure with front-flush diaphragm

Conformity error at limit point setting, including hysteresis and repeatability		
Measuring span ratio r (turndown)	r = max. measuring span/set measuring span and nominal measuring range	
Linear characteristic curve	$r \leq 10$	$10 < r \leq 30$
All measuring cells	$\leq 0.2\%$	$\leq 0.4\%$



<b>Effect of ambient temperature</b>	
In percent per 28 °C (50 °F)	
All measuring cells	$\leq (0.16 \cdot r + 0.24)$
<b>Long-term stability at <math>\pm 30</math> °C (<math>\pm 54</math> °F)</b>	
All measuring cells	In 5 years $\leq (0.25 \cdot r)\%$
<b>Step response time <math>T_{63}</math> (without electrical damping)</b>	
Approx. 0.105 s	
<b>Effect of mounting position</b>	
In pressure per change of angle 0.04 kPa/0.4 mbar/0.006 psi per 10° incline (zero-point correction is possible with position error compensation)	

### 13.2.8 Absolute pressure from the differential pressure series

<b>Conformity error at limit point setting, including hysteresis and repeatability - Absolute pressure from the differential pressure series</b>		
Measuring span ratio r (turndown)	r = max. measuring span/set measuring span and nominal measuring range	
<b>• Linear characteristic curve</b>	<b>r ≤ 5</b>	<b>5 &lt; r ≤ 30</b>
250 mbar a/25 kPa a/3.6 psi a	$\leq 0.075\%$	$\leq (0.02 \cdot r + 0.05)\%$
1300 mbar a/130 kPa a/18.8 psi a		$\leq (0.005 \cdot r + 0.05)\%$
5 bar a/500 kPa a/72.5 psi a		
30 bar a/3000 kPa a/435 psi a		
<b>• Linear characteristic curve</b>		<b>5 &lt; r ≤ 20</b>
160 bar a/16 MPa a/2321 psi a		$\leq (0.005 \cdot r + 0.05)\%$

<b>Effect of the ambient temperature - Absolute pressure from differential pressure series</b>	
In percent per 28 °C (50 °F)	
250 mbar a/25 kPa a/3.6 psi a	$\leq (0.1 \cdot r + 0.1)\%$
1300 mbar a/130 kPa a/18.8 psi a	$\leq (0.025 \cdot r + 0.125)\%$
5 bar a/500 kPa a/72.5 psi a	
30 bar a/3000 kPa a/435 psi a	
160 bar a/16 MPa a/2321 psi a	

13.2 Measuring accuracy of SITRANS P320

Long-term stability at ±30 °C (±54 °F) - Absolute pressure from differential pressure series	
250 mbar a/25 kPa a/3.6 psi a	In 5 years ≤ (0.2 • r)%
1300 mbar a/130 kPa a/18.8 psi a	In 5 years ≤ (0.1 • r)%
5 bar a/500 kPa a/72.5 psi a	In 10 years ≤ (0.15 • r)%
30 bar a/3000 kPa a/435 psi a	
160 bar a/16 MPa a/2321 psi a	

Step response time T <sub>63</sub> (without electrical damping) - Absolute pressure from differential pressure series	
250 mbar a/25 kPa a/3.6 psi a	Approx. 0.135 s
1300 mbar a/130 kPa a/18.8 psi a	
5 bar a/500 kPa a/72.5 psi a	
30 bar a/3000 kPa a/435 psi a	
160 bar a/16 MPa a/2321 psi a	

Effect of mounting position - Absolute pressure from differential pressure series	
In pressure per change of angle:	
≤ 0.7 mbar/0.07 kPa/0.001015 psi per 10° incline	
(zero-point correction is possible with position error compensation)	

13.2.9 Differential pressure and flow

Conformity error at limit point setting, including hysteresis and repeatability - differential pressure and flow		
Measuring span ratio r (turndown)	r = max. measuring span/set measuring span and nominal measuring range	
<b>Linear characteristic curve</b>	<b>r ≤ 5</b>	<b>5 &lt; r ≤ 20</b>
20 mbar/2 kPa/0.29 psi	≤ 0.075%	≤ (0.005 • r + 0.05)%
<b>Linear characteristic curve</b>	<b>r ≤ 5</b>	<b>5 &lt; r ≤ 60</b>
60 mbar/6 kPa/0.87 psi	≤ 0.075%	≤ (0.005 • r + 0.05)%
<b>Linear characteristic curve</b>	<b>r ≤ 5</b>	<b>5 &lt; r ≤ 100</b>
250 mbar/25 kPa/3.63 psi	≤ 0.065%	≤ (0.004 • r + 0.045)%
600 mbar/60 kPa/8.70 psi		
1600 mbar/160 kPa/23.21 psi		
5 bar/500 kPa/72.52 psi		
30 bar/3 MPa/435.11 psi		
<b>Linear characteristic curve</b>	<b>r ≤ 5</b>	<b>5 &lt; r ≤ 20</b>
160 bar/16 MPa/2320 psi	≤ 0.065%	≤ (0.004 • r + 0.045)%
<b>Root extraction characteristic</b>	<b>r ≤ 5</b>	<b>5 &lt; r ≤ 20</b>

13.2 Measuring accuracy of SITRANS P320

<b>Conformity error at limit point setting, including hysteresis and repeatability - differential pressure and flow</b>			
	Flow > 50%		
	20 mbar/2 kPa/0.29 psi	≤ 0.075%	≤ (0.005 • r + 0.05)%
<b>Root extraction characteristic</b>		<b>r ≤ 5</b>	<b>5 &lt; r ≤ 60</b>
	Flow > 50%		
	60 mbar/6 kPa/0.87 psi	≤ 0.075%	≤ (0.005 • r + 0.05)%
<b>Root extraction characteristic</b>		<b>r ≤ 5</b>	<b>5 &lt; r ≤ 100</b>
	Flow > 50%		
	250 mbar/25 kPa/3.63 psi	≤ 0.065%	≤ (0.004 • r + 0.045)%
	600 mbar/60 kPa/8.70 psi		
	1600 mbar/160 kPa/23.21 psi		
	5 bar/500 kPa/72.52 psi		
	30 bar/3 MPa/435.11 psi		
		<b>r ≤ 5</b>	<b>5 &lt; r ≤ 20</b>
	160 bar/16 MPa/2320 psi	≤ 0.065%	≤ (0.004 • r + 0.045)%
<b>Root extraction characteristic</b>		<b>r ≤ 5</b>	<b>5 &lt; r ≤ 20</b>
	Flow 25 ... 50%		
	20 mbar/2 kPa/0.29 psi	≤ 0.15%	≤ (0.01 • r + 0.1)%
<b>Root extraction characteristic</b>		<b>r ≤ 5</b>	<b>5 &lt; r ≤ 60</b>
	Flow 25 ... 50%		
	60 mbar/6 kPa/0.87 psi	≤ 0.15%	≤ (0.01 • r + 0.1)%
<b>Root extraction characteristic</b>		<b>r ≤ 5</b>	<b>5 &lt; r ≤ 100</b>
	Flow 25 ... 50%		
	250 mbar/25 kPa/3.63 psi	≤ 0.13%	≤ (0.008 • r + 0.09)%
	600 mbar/60 kPa/8.70 psi		
	1600 mbar/160 kPa/23.21 psi		
	5 bar/500 kPa/72.52 psi		
	30 bar/3 MPa/435.11 psi		
		<b>r ≤ 5</b>	<b>5 &lt; r ≤ 20</b>
	160 bar/16 MPa/2320 psi	≤ 0.13%	≤ (0.008 • r + 0.09)%
<b>Effect of ambient temperature - differential pressure and flow</b>			
In percent per 28 °C (50 °F)			
	20 mbar/2 kPa/0.29 psi	≤ (0.15 • r + 0.1)%	

13.2 Measuring accuracy of SITRANS P320

**Effect of ambient temperature - differential pressure and flow**

60 mbar/6 kPa/0.87 psi	$\leq (0.075 \cdot r + 0.1)\%$
250 mbar/25 kPa/3.63 psi	$\leq (0.025 \cdot r + 0.125)\%$
600 mbar/60 kPa/8.70 psi	
1600 mbar/160 kPa/23.21 psi	
5 bar/500 kPa/72.52 psi	
30 bar/3 MPa/435.11 psi	
160 bar/16 MPa/2320 psi	

**Effect of static pressure - differential pressure and flow**

- On the lower range value

20 mbar/2 kPa/0.29 psi	$\leq (0.3 \cdot r) \%$ per 70 bar (zero-point correction is possible with position error compensation)
60 mbar/6 kPa/0.87 psi	$\leq (0.1 \cdot r)\%$ per 70 bar (zero-point correction is possible with position error compensation)
250 mbar/25 kPa/3.63 psi	
600 mbar/60 kPa/8.70 psi	
1600 mbar/160 kPa/23.21 psi	
30 bar/3 MPa/435.11 psi	
160 bar/16 MPa/2320 psi	
5 bar/500 kPa/72.52 psi	$\leq (0.15 \cdot r)\%$ per 70 bar (zero-point correction is possible with position error compensation)

- On the measuring span

20 mbar/2 kPa/0.29 psi	$\leq 0.2\%$ per 70 bar
60 mbar/6 kPa/0.87 psi	$\leq 0.1\%$ per 70 bar
250 mbar/25 kPa/3.63 psi	
600 mbar/60 kPa/8.70 psi	
1600 mbar/160 kPa/23.21 psi	
5 bar/500 kPa/72.52 psi	
30 bar/3 MPa/435.11 psi	
160 bar/16 MPa/2320 psi	

**Long-term stability at  $\pm 30\text{ }^\circ\text{C}$  ( $\pm 54\text{ }^\circ\text{F}$ ) - differential pressure and flow**

Static pressure max. 70 bar/7 MPa/1015 psi

20 mbar/2 kPa/0.29 psi	Per year $\leq (0.2 \cdot r)\%$
60 mbar/6 kPa/0.87 psi	In 5 years $\leq (0.25 \cdot r)\%$
250 mbar/25 kPa/3.63 psi	In 5 years $\leq (0.125 \cdot r)\%$
600 mbar/60 kPa/8.70 psi	In 10 years $\leq (0.15 \cdot r)\%$
1600 mbar/160 kPa/23.21 psi	
5 bar/500 kPa/72.52 psi	
30 bar/3 MPa/435.11 psi	
160 bar/16 MPa/2320 psi	



13.3 Measuring accuracy of SITRANS P420

<b>Effect of ambient temperature<sup>1)</sup> - level</b>	
In percent per 28 °C (50 °F)	
250 mbar/25 kPa/3.63 psi	$\leq (0.025 \cdot r + 0.125)\%$
600 mbar/60 kPa/8.70 psi	
1600 mbar/160 kPa/23.21 psi	
5 bar/500 kPa/72.52 psi	
1) Data only applies to the basic unit. The error of the remote seal must be considered additively.	
<b>Effect of static pressure - level</b>	
• On the lower range value	
250 mbar/25 kPa/3.63 psi	$\leq (0.1 \cdot r)\%$ per 70 bar (zero-point correction is possible with position error compensation)
600 mbar/60 kPa/8.70 psi	
1600 mbar/160 kPa/23.21 psi	
5 bar/500 kPa/72.52 psi	$\leq (0.15 \cdot r)\%$ per 70 bar (zero-point correction is possible with position error compensation)
• On the measuring span	
	$\leq (0.1 \cdot r)\%$ per 70 bar
<b>Long-term stability at ±30 °C (±54 °F) - level</b>	
All measuring cells	In 5 years $\leq (0.25 \cdot r)\%$ static pressure max. 70 bar/7 MPa/1015 psi
<b>Effect of mounting position - level</b>	
Depends on the fill fluid in the mounting flange	

## 13.3 Measuring accuracy of SITRANS P420

### 13.3.1 Reference conditions

- According to IEC 62828-1
- Rising characteristic curve
- Lower range value 0 bar/kPa/psi
- Seal diaphragm stainless steel
- Measuring cell with silicone oil filling
- Room temperature 25 °C (77 °F)

### 13.3.2 Effect of auxiliary power supply

0.005% per 1 V (in percent per change in voltage)

### 13.3.3 Gauge pressure

<b>Conformity error at limit point setting, including hysteresis and repeatability - gauge pressure</b>		
Measuring span ratio r (turndown)	r = max. measuring span/set measuring span and nominal measuring range	
• <b>Linear characteristic curve</b>	<b>r ≤ 1.25</b>	<b>1.25 &lt; r ≤ 30</b>
250 mbar/25 kPa/3.6 psi	≤ 0.065%	≤ (0.008 • r + 0.055)%
• <b>Linear characteristic curve</b>	<b>r ≤ 5</b>	<b>5 &lt; r ≤ 100</b>
1 bar/100 kPa/14.5 psi	≤ 0.04%	≤ (0.004 • r + 0.045)%
4 bar/400 kPa/58 psi		
16 bar/1.6 MPa/232 psi		
63 bar/6.3 MPa/914 psi		
160 bar/16 MPa/2321 psi		
• <b>Linear characteristic curve</b>	<b>r ≤ 5</b>	<b>5 &lt; r ≤ 100</b>
400 bar/40 MPa/5802 psi	≤ 0.075%	≤ (0.005 • r + 0.05)%
700 bar/70 MPa/10152 psi		
<b>Effect of ambient temperature - gauge pressure</b>		
In percent per 28 °C (50 °F)		
250 mbar/25 kPa/3.6 psi	≤ (0.16 • r + 0.1)%	
1 bar/100 kPa/14.5 psi	≤ (0.05 • r + 0.1)%	
4 bar/400 kPa/58 psi	≤ (0.025 • r + 0.125)%	
16 bar/1.6 MPa/232 psi		
63 bar/6.3 MPa/914 psi		
160 bar/16 MPa/2321 psi		
400 bar/40 MPa/5802 psi		
700 bar/70 MPa/10152 psi	≤ (0.08 • r + 0.16)%	
<b>Long-term stability at ±30 °C (±54 °F) - gauge pressure</b>		
250 mbar/25 kPa/3.6 psi	Per year ≤ (0.25 • r)%	
1 bar/100 kPa/14.5 psi	In 5 years ≤ (0.25 • r)%	
	In 10 years ≤ (0.35 • r)%	

13.3 Measuring accuracy of SITRANS P420

Long-term stability at ±30 °C (±54 °F) - gauge pressure	
4 bar/400 kPa/58 psi	In 5 years ≤ (0.125 • r)%
16 bar/1.6 MPa/232 psi	In 10 years ≤ (0.15 • r)%
63 bar/6.3 MPa/914 psi	
160 bar/16 MPa/2321 psi	
400 bar/40 MPa/5802 psi	
700 bar/70 MPa/10152 psi	In 5 years ≤ (0.25 • r)%
	In 10 years ≤ (0.35 • r)%

Step response time T <sub>63</sub> (without electrical damping) - gauge pressure
Approx. 0.105 s

Effect of mounting position - gauge pressure
≤ 0.05 mbar/0.005 kPa/0.000725 psi per 10° incline (zero-point correction is possible with position error compensation)

13.3.4 Gauge pressure with front-flush diaphragm

Conformity error at limit point setting, including hysteresis and repeatability - gauge pressure with front-flush diaphragm		
Measuring span ratio r (turndown)	r = max. measuring span/set measuring span and nominal measuring range	
• Linear characteristic curve	r ≤ 5	5 < r ≤ 100
1 bar/100 kPa/14.5 psi	≤ 0.075%	≤ (0.005 • r + 0.05)%
4 bar/400 kPa/58 psi		
16 bar/1.6 MPa/232 psi		
63 bar/6.3 MPa/914 psi		

Effect of ambient temperature - gauge pressure with front-flush diaphragm	
In percent per 28 °C (50 °F)	
1 bar/100 kPa/14.5 psi	≤ (0.08 • r + 0.16)%
4 bar/400 kPa/58 psi	
16 bar/1.6 MPa/232 psi	
63 bar/6.3 MPa/914 psi	



**Long-term stability at ±30 °C (±54 °F) - gauge pressure with front-flush diaphragm**

1 bar/100 kPa/14.5 psi	In 5 years ≤ (0.25 • r)%
4 bar/400 kPa/58 psi	
16 bar/1.6 MPa/232 psi	In 5 years ≤ (0.125 • r)%
63 bar/6.3 MPa/914 psi	

**Step response time T<sub>63</sub> (without electrical damping) - gauge pressure with front-flush diaphragm**

Approx. 0.105 s

**Effect of mounting position - gauge pressure with front-flush diaphragm**

≤ 0.4 mbar/0.04 kPa/0.006 psi per 10° incline  
(zero-point correction is possible with position error compensation)

### 13.3.5 Gauge pressure from the differential pressure series

**Conformity error at limit point setting, including hysteresis and repeatability - gauge pressure from differential pressure series**

Measuring span ratio r (turndown)	r = max. measuring span/set measuring span and nominal measuring range	
• <b>Linear characteristic curve</b>	<b>r ≤ 5</b>	<b>5 &lt; r ≤ 20</b>
20 mbar/2 kPa/8.031 inH <sub>2</sub> O	≤ 0.075%	≤ (0.005 • r + 0.05)%
• <b>Linear characteristic curve</b>	<b>r ≤ 5</b>	<b>5 &lt; r ≤ 60</b>
60 mbar/6 kPa/24.09 inH <sub>2</sub> O	≤ 0.075%	≤ (0.005 • r + 0.05)%
• <b>Linear characteristic curve</b>	<b>r ≤ 5</b>	<b>5 &lt; r ≤ 100</b>
250 mbar/25 kPa/3.6 psi	≤ 0.04%	≤ (0.004 • r + 0.045)%
600 mbar/60 kPa/240.9 inH <sub>2</sub> O		
1600 mbar/160 kPa/642.4 inH <sub>2</sub> O		
5000 mbar/500 kPa/2008 inH <sub>2</sub> O		
30 bar/3 MPa/435 psi		
• <b>Linear characteristic curve</b>	<b>r ≤ 5</b>	<b>5 &lt; r ≤ 20</b>
160 bar/16 MPa/2320 psi	≤ 0.04%	≤ (0.004 • r + 0.045)%

**Effect of ambient temperature - gauge pressure from differential pressure series**

In percent per 28 °C (50 °F)	
20 mbar/2 kPa/8.031 inH <sub>2</sub> O	≤ (0.15 • r + 0.1)%
60 mbar/6 kPa/24.09 inH <sub>2</sub> O	≤ (0.075 • r + 0.1)%

Technical data

13.3 Measuring accuracy of SITRANS P420

Effect of ambient temperature - gauge pressure from differential pressure series	
250 mbar/25 kPa/3.6 psi	$\leq (0.025 \cdot r + 0.0625)\%$
5000 mbar/500 kPa/2008 inH <sub>2</sub> O	
600 mbar/60 kPa/240.9 inH <sub>2</sub> O	$\leq (0.0125 \cdot r + 0.0625)\%$
1600 mbar/160 kPa/642.4 inH <sub>2</sub> O	
30 bar/3 MPa/435 psi	
160 bar/16 MPa/2320 psi	

Long-term stability at $\pm 30\text{ }^\circ\text{C}$ ( $\pm 54\text{ }^\circ\text{F}$ ) - gauge pressure from differential pressure series	
20 mbar/2 kPa/8.031 inH <sub>2</sub> O	Per year $\leq (0.2 \cdot r)\%$
60 mbar/6 kPa/24.09 inH <sub>2</sub> O	In 5 years $\leq (0.25 \cdot r)\%$
250 mbar/25 kPa/3.6 psi	In 5 years $\leq (0.125 \cdot r)\%$
600 mbar/60 kPa/240.9 inH <sub>2</sub> O	In 10 years $\leq (0.15 \cdot r)\%$
1600 mbar/160 kPa/642.4 inH <sub>2</sub> O	
5000 mbar/500 kPa/2008 inH <sub>2</sub> O	
30 bar/3 MPa/435 psi	
160 bar/16 MPa/2320 psi	

Step response time $T_{63}$ (without electrical damping) - gauge pressure from differential pressure series	
20 mbar/2 kPa/8.031 inH <sub>2</sub> O	Approx. 0.160 s
60 mbar/6 kPa/24.09 inH <sub>2</sub> O	Approx. 0.150 s
250 mbar/25 kPa/3.6 psi	Approx. 0.135 s
600 mbar/60 kPa/240.9 inH <sub>2</sub> O	
1600 mbar/160 kPa/642.4 inH <sub>2</sub> O	
5000 mbar/500 kPa/2008 inH <sub>2</sub> O	
30 bar/3 MPa/435 psi	
160 bar/16 MPa/2320 psi	

Effect of mounting position
$\leq 0.7\text{ mbar}/0.07\text{ kPa}/0.01015266\text{ psi}$ per $10^\circ$ incline (zero-point correction is possible with position error compensation)

13.3.6 Absolute pressure from the gauge pressure series

Conformity error at limit point setting, including hysteresis and repeatability - Absolute pressure from gauge pressure series		
Measuring span ratio $r$ (turndown)	$r = \text{max. measuring span}/\text{set measuring span and nominal measuring range}$	
• Linear characteristic curve	$r \leq 10$	$10 < r \leq 30$
All measuring cells	$\leq 0.1\%$	$\leq 0.2\%$

**Effect of ambient temperature -- Absolute pressure from the gauge pressure series**

In percent per 28 °C (50 °F)

250 mbar a/25 kPa a/3.6 psi a	$\leq (0.15 \cdot r + 0.1)$
1300 mbar a/130 kPa a/18.8 psi a	$\leq (0.08 \cdot r + 0.16)$
5 bar a/500 kPa a/72.5 psi a	
30 bar a/3000 kPa a/435 psi a	
160 bar a/16 MPa a/2321 psi a	
400 bar a/40 MPa a/5802 psi a	
700 bar a/70 MPa a/10152.6 psi a	

**Long-term stability at ±30 °C (±54 °F) - Absolute pressure from gauge and differential pressure series**

In 5 years  $\leq (0.25 \cdot r)\%$

**Step response time  $T_{63}$  (without electrical damping) - Absolute pressure from gauge pressure series**

All measuring cells Approx. 0.105 s

**Effect of mounting position - Absolute pressure from the gauge pressure series**

In pressure per change of angle

$\leq 0.05$  mbar/0.005 kPa/0.000725 psi per 10° incline

(zero-point correction is possible using the zero point adjustment)

### 13.3.7 Absolute pressure with front-flush diaphragm

**Conformity error at limit point setting, including hysteresis and repeatability**

Measuring span ratio r (turndown)	$r = \text{max. measuring span/set measuring span and nominal measuring range}$	
<b>Linear characteristic curve</b>	$r \leq 10$	$10 < r \leq 30$
All measuring cells	$\leq 0.2\%$	$\leq 0.4\%$

**Effect of ambient temperature**

In percent per 28 °C (50 °F)

All measuring cells  $\leq (0.16 \cdot r + 0.24)$

**Long-term stability at ±30 °C (±54 °F)**

All measuring cells In 5 years  $\leq (0.25 \cdot r)\%$

13.3 Measuring accuracy of SITRANS P420

**Step response time  $T_{63}$  (without electrical damping)**

Approx. 0.105 s

**Effect of mounting position**

In pressure per change of angle  
 0.04 kPa/0.4 mbar/0.006 psi per 10° incline  
 (zero-point correction is possible with position error compensation)

**13.3.8 Absolute pressure from the differential pressure series**

**Conformity error at limit point setting, including hysteresis and repeatability - Absolute pressure from the differential pressure series**

Measuring span ratio r (turndown)	r = max. measuring span/set measuring span and nominal measuring range		
<ul style="list-style-type: none"> <li>Linear characteristic curve</li> </ul>	$r \leq 5$	$5 < r \leq 30$	
	250 mbar a/25 kPa a/3.6 psi a	$\leq 0.075\%$	$\leq (0.02 \cdot r + 0.05)\%$
	1300 mbar a/130 kPa a/18.8 psi a		$\leq (0.005 \cdot r + 0.05)\%$
	5 bar a/500 kPa a/72.5 psi a 30 bar a/3000 kPa a/435 psi a		
<ul style="list-style-type: none"> <li>Linear characteristic curve</li> </ul>		$5 < r \leq 20$	
	160 bar a/16 MPa a/2321 psi a		$\leq (0.005 \cdot r + 0.05)\%$

**Effect of the ambient temperature - Absolute pressure from differential pressure series**

In percent per 28 °C (50 °F)	
250 mbar a/25 kPa a/3.6 psi a	$\leq (0.1 \cdot r + 0.1)\%$
1300 mbar a/130 kPa a/18.8 psi a	$\leq (0.025 \cdot r + 0.125)\%$
5 bar a/500 kPa a/72.5 psi a	
30 bar a/3000 kPa a/435 psi a	
160 bar a/16 MPa a/2321 psi a	

**Long-term stability at  $\pm 30$  °C ( $\pm 54$  °F) - Absolute pressure from differential pressure series**

250 mbar a/25 kPa a/3.6 psi a	In 5 years $\leq (0.2 \cdot r)\%$
1300 mbar a/130 kPa a/18.8 psi a	In 5 years $\leq (0.1 \cdot r)\%$
5 bar a/500 kPa a/72.5 psi a	In 10 years $\leq (0.15 \cdot r)\%$
30 bar a/3000 kPa a/435 psi a	
160 bar a/16 MPa a/2321 psi a	

**Step response time  $T_{63}$  (without electrical damping) - Absolute pressure from differential pressure series**

250 mbar a/25 kPa a/3.6 psi a	Approx. 0.135 s
1300 mbar a/130 kPa a/18.8 psi a	
5 bar a/500 kPa a/72.5 psi a	
30 bar a/3000 kPa a/435 psi a	
160 bar a/16 MPa a/2321 psi a	

**Effect of mounting position - Absolute pressure from differential pressure series**

In pressure per change of angle:  
 $\leq 0.7$  mbar/0.07 kPa/0.001015 psi per 10° incline  
 (zero-point correction is possible with position error compensation)

**13.3.9 Differential pressure and flow**

**Conformity error at limit point setting, including hysteresis and repeatability - differential pressure and flow**

Measuring span ratio r (turndown)	r = max. measuring span/set measuring span and nominal measuring range	
<b>Linear characteristic curve</b>	<b>r ≤ 5</b>	<b>5 &lt; r ≤ 20</b>
20 mbar/2 kPa/0.29 psi	≤ 0.075%	≤ (0.005 • r + 0.05)%
<b>Linear characteristic curve</b>	<b>r ≤ 5</b>	<b>5 &lt; r ≤ 60</b>
60 mbar/6 kPa/0.87 psi	≤ 0.075%	≤ (0.005 • r + 0.05)%
<b>Linear characteristic curve</b>	<b>r ≤ 5</b>	<b>5 &lt; r ≤ 100</b>
250 mbar/25 kPa/3.63 psi (MAWP 160 bar (2320 psi))	≤ 0.04%	≤ (0.004 • r + 0.045)%
600 mbar/60 kPa/8.70 psi		
1600 mbar/160 kPa/23.21 psi		
5 bar/500 kPa/72.52 psi		
30 bar/3 MPa/435.11 psi		
250 mbar/25 kPa/3.63 psi (MAWP 420 bar (6092 psi))	≤ 0.065%	
600 mbar/60 kPa/8.70 psi		
1600 mbar/160 kPa/23.21 psi		
5 bar/500 kPa/72.52 psi		
30 bar/3 MPa/435.11 psi		
<b>Linear characteristic curve</b>	<b>r ≤ 5</b>	<b>5 &lt; r ≤ 20</b>
160 bar/16 MPa/2320 psi	≤ 0.04%	≤ (0.004 • r + 0.045)%
<b>Root extraction characteristic</b>	<b>r ≤ 5</b>	<b>5 &lt; r ≤ 20</b>
Flow > 50%		
20 mbar/2 kPa/0.29 psi	≤ 0.075%	≤ (0.005 • r + 0.05)%

13.3 Measuring accuracy of SITRANS P420

<b>Conformity error at limit point setting, including hysteresis and repeatability - differential pressure and flow</b>		
<b>Root extraction characteristic</b>	<b>r ≤ 5</b>	<b>5 &lt; r ≤ 60</b>
Flow > 50%		
60 mbar/6 kPa/0.87 psi	≤ 0.075%	≤ (0.005 • r + 0.05)%
<b>Root extraction characteristic</b>	<b>r ≤ 5</b>	<b>5 &lt; r ≤ 100</b>
Flow > 50%		
250 mbar/25 kPa/3.63 psi	≤ 0.04%	≤ (0.004 • r + 0.045)%
600 mbar/60 kPa/8.70 psi		
1600 mbar/160 kPa/23.21 psi		
5 bar/500 kPa/72.52 psi		
30 bar/3 MPa/435.11 psi		
	<b>r ≤ 5</b>	<b>5 &lt; r ≤ 20</b>
160 bar/16 MPa/2320 psi	≤ 0.04%	≤ (0.004 • r + 0.045)%
<b>Root extraction characteristic</b>	<b>r ≤ 5</b>	<b>5 &lt; r ≤ 20</b>
Flow 25 ... 50%		
20 mbar/2 kPa/0.29 psi	≤ 0.15%	≤ (0.01 • r + 0.1)%
<b>Root extraction characteristic</b>	<b>r ≤ 5</b>	<b>5 &lt; r ≤ 60</b>
Flow 25 ... 50%		
60 mbar/6 kPa/0.87 psi	≤ 0.15%	≤ (0.01 • r + 0.1)%
<b>Root extraction characteristic</b>	<b>r ≤ 5</b>	<b>5 &lt; r ≤ 100</b>
Flow 25 ... 50%		
250 mbar/25 kPa/3.63 psi	≤ 0.08%	≤ (0.008 • r + 0.09)%
600 mbar/60 kPa/8.70 psi		
1600 mbar/160 kPa/23.21 psi		
5 bar/500 kPa/72.52 psi		
30 bar/3 MPa/435.11 psi		
	<b>r ≤ 5</b>	<b>5 &lt; r ≤ 20</b>
160 bar/16 MPa/2320 psi	≤ 0.08%	≤ (0.008 • r + 0.09)%
<b>Effect of ambient temperature - differential pressure and flow</b>		
In percent per 28 °C (50 °F)		
20 mbar/2 kPa/0.29 psi	≤ (0.15 • r + 0.1)%	
60 mbar/6 kPa/0.87 psi	≤ (0.075 • r + 0.1)%	
250 mbar/25 kPa/3.63 psi	≤ (0.025 • r + 0.0625)%	
600 mbar/60 kPa/8.70 psi	≤ (0.0125 • r + 0.0625)%	
1600 mbar/160 kPa/23.21 psi		

**Effect of ambient temperature - differential pressure and flow**

5 bar/500 kPa/72.52 psi	$\leq (0.025 \cdot r + 0.0625)\%$
30 bar/3 MPa/435.11 psi	$\leq (0.0125 \cdot r + 0.0625)\%$
160 bar/16 MPa/2320 psi	

**Effect of static pressure - differential pressure and flow**

- On the lower range value

20 mbar/2 kPa/0.29 psi	$\leq (0.2 \cdot r) \%$ per 70 bar (zero-point correction is possible with position error compensation)
60 mbar/6 kPa/0.87 psi	$\leq (0.1 \cdot r)\%$ per 70 bar (zero-point correction is possible with position error compensation)
250 mbar/25 kPa/3.63 psi	
600 mbar/60 kPa/8.70 psi	
1600 mbar/160 kPa/23.21 psi	
30 bar/3 MPa/435.11 psi	
160 bar/16 MPa/2320 psi	
5 bar/500 kPa/72.52 psi	$\leq (0.15 \cdot r)\%$ per 70 bar (zero-point correction is possible with position error compensation)

- On the measuring span

20 mbar/2 kPa/0.29 psi	$\leq 0.2\%$ per 70 bar
60 mbar/6 kPa/0.87 psi	$\leq 0.1\%$ per 70 bar
250 mbar/25 kPa/3.63 psi	
600 mbar/60 kPa/8.70 psi	
1600 mbar/160 kPa/23.21 psi	
5 bar/500 kPa/72.52 psi	
30 bar/3 MPa/435.11 psi	
160 bar/16 MPa/2320 psi	

**Long-term stability at  $\pm 30\text{ }^\circ\text{C}$  ( $\pm 54\text{ }^\circ\text{F}$ ) - differential pressure and flow**

Static pressure max. 70 bar/7 MPa/1015 psi

20 mbar/2 kPa/0.29 psi	Per year $\leq (0.2 \cdot r)\%$
60 mbar/6 kPa/0.87 psi	In 5 years $\leq (0.25 \cdot r)\%$
250 mbar/25 kPa/3.63 psi	In 5 years $\leq (0.125 \cdot r)\%$
600 mbar/60 kPa/8.70 psi	In 10 years $\leq (0.15 \cdot r)\%$
1600 mbar/160 kPa/23.21 psi	
5 bar/500 kPa/72.52 psi	
30 bar/3 MPa/435.11 psi	
160 bar/16 MPa/2320 psi	

Technical data

13.3 Measuring accuracy of SITRANS P420

Step response time $T_{63}$ (without electrical damping) - Differential pressure and flow (MAWP 160 bar)	
20 mbar/2 kPa/0.29 psi	Approx. 0.160 s
60 mbar/6 kPa/0.87 psi	Approx. 0.150 s
250 mbar/25 kPa/3.63 ps 600 mbar/60 kPa/8.70 psi 1600 mbar/160 kPa/23.21 psi 5 bar/500 kPa/72.52 psi 30 bar/3 MPa/435.11 psi 160 bar/16 MPa/2320 psi	Approx. 0.135 s

Step response time $T_{63}$ (without electrical damping) - Differential pressure and flow (MAWP 420 bar)	
250 mbar/25 kPa/3.63 psi	Approx. 0.135 s
600 mbar/60 kPa/8.70 psi 1600 mbar/160 kPa/23.21 psi 5 bar/500 kPa/72.52 psi 30 bar/3 MPa/435.11 psi	Approx. 0.2 s

Effect of mounting position - differential pressure and flow
In pressure per change of angle $\leq 0.7$ mbar/0.07 kPa/0.028 inH <sub>2</sub> O per 10° incline (zero-point correction is possible with position error compensation)

13.3.10 Level

Conformity error at limit point setting, including hysteresis and repeatability - level		
Measuring span ratio $r$ (turndown)	$r = \text{max. measuring span/set measuring span and nominal measuring range}$	
• Linear characteristic curve	$r \leq 5$	$5 < r \leq 10$
250 mbar/25 kPa/3.63 psi 600 mbar/60 kPa/8.70 psi 1600 mbar/160 kPa/23.21 psi 5 bar/500 kPa/72.52 psi	$\leq 0.125\%$	$\leq (0.007 \cdot r + 0.09) \%$



**Effect of ambient temperature<sup>1)</sup> - level**

In percent per 28 °C (50 °F)

250 mbar/25 kPa/3.63 psi  $\leq (0.025 \cdot r + 0.0625)\%$

5 bar/500 kPa/72.52 psi

600 mbar/60 kPa/8.70 psi  $\leq (0.125 \cdot r + 0.0625)\%$

1600 mbar/160 kPa/23.21 psi

<sup>1)</sup> Data only applies to the basic unit. The error of the remote seal must be considered additively.

**Effect of static pressure - level**

- On the lower range value

250 mbar/25 kPa/3.63 psi  $\leq (0.3 \cdot r) \%$  per 70 bar (zero-point correction is possible with position error compensation)

600 mbar/60 kPa/8.70 psi  $\leq (0.15 \cdot r)\%$  per 70 bar (zero-point correction is possible with position error compensation)

1600 mbar/160 kPa/23.21 psi

5 bar/500 kPa/72.52 psi

- On the measuring span  $\leq (0.1 \cdot r)\%$  per 70 bar

**Long-term stability at  $\pm 30$  °C ( $\pm 54$  °F) - level**

All measuring cells In 5 years  $\leq (0.25 \cdot r)\%$  static pressure max. 70 bar/7 MPa/1015 psi

**Effect of mounting position - level**

Depends on the fill fluid in the mounting flange

## 13.4 Output

**Output**

**HART**

Output signal 4 ... 20 mA

- Low saturation limit (continuously adjustable) 3.55 mA, set to 3.8 mA in the factory

- High saturation limit (continuously adjustable) 22.8 mA, factory-set to 20.5 mA or optionally 22.0 mA

- Ripple (without HART communication)  $I_{SS} \leq 0.5 \%$  of the max. output current

Adjustable damping 0 ... 100 s, continuously adjustable over remote operation  
0 ... 100 s, in steps of 0.1 s adjustable over display

- Current transmitter 3.55 ... 22.8 mA

- Failure signal 3.55 ... 22.8 mA

Load Resistor R [ $\Omega$ ]

13.5 Operating conditions

Output	
	<b>HART</b>
• Without HART communication	$R = \frac{U_H - 10,5 \text{ V}}{22,8 \text{ mA}}$
	$U_H$ Power supply in V
• With HART communication	
HART communicator (Handheld)	R = 230 ... 1100 Ω
SIMATIC PDM	R = 230 ... 600 Ω
Characteristic curve	<ul style="list-style-type: none"> <li>• Linearly increasing or linearly decreasing</li> <li>• Linear increase or decrease or according to the square root (only for differential pressure and flow)</li> </ul>
Bus physics	–
Polarity-independent	–

### 13.5 Operating conditions

Operating conditions for gauge pressure and absolute pressure (from the gauge pressure series)		
Ambient conditions		
• Ambient temperature	Note: Observe the temperature class in hazardous areas.	
Enclosure	-40 ... +100 °C (-40 ... +212 °F)	
Measuring cell with silicone oil filling	-40 ... +85 °C (-40 ... +185 °F)	
Measuring cell with inert oil	-40 ... +85 °C (-40 ... +185 °F)	
Measuring cell with FDA-compliant oil	-10 ... +85 °C (14 ... +185 °F)	
Display	-20 ... +80 °C (-4 ... +185 °F)	
• Storage temperature	-50 ... +85 °C (-58 ... +185 °F) (for FDA-compliant oil: -20 ... +85 °C (-4 ... +185 °F))	
Climate class in accordance with IEC 60721-3-4	4K26	
Degree of protection according to IEC/EN 60529/UL50-E	Enclosure with appropriate cable gland	IP66/Type 4X IP68 (2 hours at 1.5 m)
	Enclosure with mounted M12 device plug <sup>1)</sup>	IP66/Type 4X
	Enclosure with external overvoltage protection up to 6 kV	IP66/Type 4X
	Enclosure with mounted HAN device plug <sup>1)</sup>	IP65
Electromagnetic compatibility		

**Operating conditions for gauge pressure and absolute pressure (from the gauge pressure series)**

Interference emission and interference immunity	In accordance with EN 61326 and NAMUR NE 21	
Process medium conditions		
• Process temperature		
<i>Cell</i>	<i>Pressure</i>	<i>Temperature range</i>
Measuring cell with silicone oil filling		-40 ... +100 °C (-40 ... +212 °F)
Measuring cell with inert oil (gauge pressure)		
	250 mbar	-40 ... +100 °C (-40 ... +212 °F)
	1 bar/100 kPa/14.5 psi	-40 ... +100 °C (-40 ... +212 °F)
	4 bar/400 kPa/58 psi	-40 ... +100 °C (-40 ... +212 °F)
	16 bar/1.6 MPa/232 psi	-40 ... +100 °C (-40 ... +212 °F)
	63 bar/6.3 MPa/914 psi	-40 ... +100 °C (-40 ... +212 °F)
	160 bar/16 MPa/2321 psi	-20 ... +100 °C (-4 ... +212 °F)
	400 bar/40 MPa/5802 psi	-20 ... +100 °C (-4 ... +212 °F)
	700 bar/70 MPa/10152 psi	-20 ... +100 °C (-4 ... +212 °F)
Measuring cell with inert oil (absolute pressure)		-20 ... +100 °C (-4 ... +212 °F)
Measuring cell with FDA-compliant oil		-10 ... +100 °C (14 ... +212 °F)

1) Only approved for non-Ex devices and devices with intrinsic safety "Ex i" according to ATEX and IECEx.

**Operating conditions for gauge pressure and absolute pressure with front-flush diaphragm**

Ambient conditions	
• Ambient temperature	
Note	Observe the temperature class in hazardous areas.
Enclosure	-40 ... +100 °C (-40 ... +212 °F)
Measuring cell with silicone oil filling	-40 ... +85 °C (-40 ... +185 °F)
Measuring cell with inert oil	-40 ... +85 °C (-40 ... +185 °F)
Measuring cell with FDA-compliant oil	-10 ... +85 °C (14 ... 185 °F)
Display	-20 ... +80 °C (-4 ... +176 °F)
• Storage temperature	-50 ... +85 °C (-58 ... +185 °F) (for FDA-compliant oil: -20 ... + 85 °C (-4 ... +185 °F))
Climate class in accordance with IEC 60721-3-4	4K26

13.5 Operating conditions

<b>Operating conditions for gauge pressure and absolute pressure with front-flush diaphragm</b>		
Degree of protection according to IEC/EN 60529/UL50-E	Enclosure with appropriate cable gland	IP66/Type 4X IP68 (2 hours at 1.5 m)
	Enclosure with mounted M12 device plug <sup>1)</sup>	IP66/Type 4X
	Enclosure with external overvoltage protection up to 6 kV	IP66/Type 4X
	Enclosure with mounted HAN device plug <sup>1)</sup>	IP65
<b>Electromagnetic compatibility</b>		
• Interference emission and interference immunity	In accordance with EN 61326 and NAMUR NE 21	
<b>Process medium conditions</b>		
<b>Process temperature<sup>2)</sup></b>		
• Measuring cell with silicone oil filling	-40 ... +150°C (-40 ... +302 °F) -40 ... +200°C (-40 ... +392 °F) with cooling extension	
• Measuring cell with inert oil	-20 ... +100 °C (-4 ... +212 °F)	
• Measuring cell with FDA-compliant oil	-10 ... +150°C (14 ... 302 °F) -10 ... +200°C (14 ... 392 °F) with cooling extension	
<sup>1)</sup> Only approved for non-Ex devices and devices with intrinsic safety "Ex i" according to ATEX and IECEx. <sup>2)</sup> Observe the temperature limits in the process connection standards (e.g. DIN 32676 and DIN 11851) for the maximum medium temperature for flush-mounted process connections.		
<b>Operating conditions for gauge pressure and absolute pressure (from the differential pressure series), differential pressure and flow</b>		
<b>Installation conditions</b>		
• Measuring cells for differential pressure with MAWP 420 bar	Dynamic stress according to AD 2000-S1 No. 1.4: <ul style="list-style-type: none"> <li>• For MAWP (PS) 420 bar: maximum 1000 load changes</li> <li>• At 10% of MAWP (PS): any number of load changes</li> </ul>	
<b>Ambient conditions</b>		
• Ambient temperature		
<b>Note</b>	Observe the temperature class in hazardous areas.	
Enclosure	-40 ... +100 °C (-40 ... +212 °F)	
Measuring cell with silicone oil filling	-40 ... +85 °C (-40 ... +185 °F)	
Measuring cell with inert oil	-40 ... +85 °C (-40 ... +185 °F)	
Measuring cell with FDA-compliant oil	-10 ... +85 °C (14 ... 185 °F)	
Display	-20 ... +80 °C (-4 ... +185 °F)	

**Operating conditions for gauge pressure and absolute pressure (from the differential pressure series), differential pressure and flow**

• Storage temperature	-50 ... +85 °C (-58 ... +185 °F) (with FDA-compliant oil: -20 ... + 85 °C (-4 ... +185 °F))	
Climate class in accordance with IEC 60721-3-4	4K26	
Degree of protection according to IEC/EN 60529/UL50-E	Enclosure with appropriate cable gland	IP66/Type 4X IP68 (2 hours at 1.5 m)
	Enclosure with mounted M12 device plug <sup>1)</sup>	IP66/Type 4X
	Enclosure with external overvoltage protection up to 6 kV	IP66/Type 4X
	Enclosure with mounted HAN device plug <sup>1)</sup>	IP65
Electromagnetic compatibility		
Interference emission and interference immunity	In accordance with EN 61326 and NAMUR NE 21	
Process medium conditions		
• Process temperature		
Measuring cell with silicone oil filling	-40 ... +100 °C (-40 ... +212 °F)	
• Measuring cell 30 bar (435.11 psi)	-20 ... +100°C (-4 ... +212 °F)	
• Measuring cell 160 bar (2320 psi) <sup>2)</sup>	-20 ... +100°C (-4 ... +212 °F)	
Measuring cell with inert oil	-20 ... +100 °C (-4 ... +212 °F)	
Measuring cell with FDA-compliant oil	-10 ... +100°C (14 ...+212°F)	

<sup>1)</sup> Only approved for non-Ex devices and devices with intrinsic safety "Ex i" according to ATEX and IECEx.

<sup>2)</sup> With O-rings made of fluoroelastomer (FKM) or perfluoroelastomer (FFKM or FFPM), the medium temperature limit is -10 ... +100°C (14 ... +212°F)

**Operating conditions for level**

Installation conditions	
• Installation instruction	Specified by the flange
Ambient conditions	
• Ambient temperature	
Note	Observe the allocation of the max. permissible operating temperature to the max. permissible operating pressure of the relevant flange connection.

## Technical data

### 13.5 Operating conditions

Operating conditions for level		
Enclosure	-40 ... +100 °C (-40 ... +212 °F)	
Measuring cell with silicone oil filling	-40 ... +85 °C (-40 ... +185 °F)	
Display	-20 ... +80 °C (-4 ... +185 °F)	
• Storage temperature	-50 ... +85 °C (-58 ... +185 °F)	
Climate class in accordance with IEC 60721-3-4	4K26	
Degree of protection according to IEC/EN 60529/UL50-E	Enclosure with appropriate cable gland	IP66/Type 4X IP68 (2 hours at 1.5 m)
	Enclosure with mounted M12 device plug <sup>1)</sup>	IP66/Type 4X
	Enclosure with external overvoltage protection up to 6 kV	IP66/Type 4X
	Enclosure with mounted HAN device plug <sup>1)</sup>	IP65
Electromagnetic compatibility		
Interference emission and interference immunity	In accordance with EN 61326 and NAMUR NE 21	
Process medium conditions		
• Process temperature		
Measuring cell with silicone oil filling	• Plus side: See mounting flange • Minus side: -40 ... +100 °C (-40 ... +212 °F)	

<sup>1)</sup> Only approved for non-Ex devices and devices with intrinsic safety "Ex i" according to ATEX and IECEx.

## 13.6 Vibration resistance

General operating conditions	Gauge pressure series <sup>2)</sup> Aluminum and stainless steel enclosure	Differential pressure series <sup>1)</sup> Aluminum and stainless steel enclosure
Vibrations (sine) IEC 60068-2-6		2 ... 9 Hz at 0.3 mm 9 ... 200 Hz at 5 m/s <sup>2</sup> 1 octave/min 5 cycles/axis
Continuous shocks (half-sine) IEC 60068-2-27		70 m/s <sup>2</sup> 30 ms 6 shocks/axis
Continuous shocks (half-sine) IEC 60068-2-27		250 m/s <sup>2</sup> 6 ms 1000 shocks/axis

1) Without mounting bracket

2) With mounting bracket

Operating conditions according to KTA 3503	Gauge pressure series <sup>2)</sup> Aluminum and stainless steel enclosure	Differential pressure series <sup>2)</sup> Aluminum and stainless steel enclosure
Vibrations (sine) IEC 60068-2-6		9 ... 35 Hz at 10 m/s <sup>2</sup> 1 octave/min 1 cycle/axis
Vibrations (sine) IEC 60068-2-6		5 ... 7 Hz at 20 mm 9 ... 100 Hz at 20 m/s <sup>2</sup> 10 octave/min 1 cycle/axis
Continuous shocks (half-sine) IEC 60068-2-27		300 m/s <sup>2</sup> 11 ms 6 shocks/axis

2) With mounting bracket

13.7 Construction

Operating conditions according to IEC 61298-3 (2g normal)	Gauge pressure series <sup>2)</sup> Aluminum and stainless steel enclosure	Differential pressure series <sup>1)2)</sup> Aluminum and stainless steel enclosure
Vibrations (sine) IEC 60068-2-6		10 ... 58 Hz at 0.3 mm 58 ... 1000 Hz at 20 m/s <sup>2</sup> 1 octave/min 20 cycles/axis

1) Without mounting bracket

2) With mounting bracket

Operating conditions according to IEC 61298-3 (5g enhanced)	Differential pressure series <sup>1)</sup> Aluminum and stainless steel enclosure
Vibrations (sine) IEC 60068-2-6	10 ... 58 Hz at 0.7 mm 58 ... 1000 Hz at 50 m/s <sup>2</sup> 1 octave/min 20 cycles/axis

1) Without mounting bracket

Operating conditions for maritime applications according to IEC 60068-2-6	Gauge pressure series <sup>1)</sup> Aluminum and stainless steel enclosure	Differential pressure series <sup>1)</sup> Aluminum and stainless steel enclosure
DNV-GL (Det Norske Veritas/Germanischer Lloyd) Lloyd's Register Bureau Veritas ABS (American Bureau of Shipping) RINA (Registro Italiano Navale) CCS (China Classification Society)		2 ... 25 Hz at 3.2 mm 25 ... 100 Hz at 40 m/s <sup>2</sup> 0.5 octave/min 1 frequency sweep/axis Amplification factor (Q) < 2, 30 Hz/90 min Amplification factor (Q) > 2, resonant frequency/90 min

1) Without mounting bracket

## 13.7 Construction

Construction for gauge pressure and absolute pressure (from the gauge pressure series)	
Weight	Approx. 1.8 kg (3.9 lb) with aluminum enclosure Approx. 3.8 kg (8.3 lb) with stainless steel enclosure
Material	<ul style="list-style-type: none"> <li>Wetted parts materials</li> </ul>



<b>Construction for gauge pressure and absolute pressure (from the gauge pressure series)</b>	
Process connection	Stainless steel, material no. 1.4404/316L or Alloy C22, material no. 2.4602
Oval flange	Stainless steel, mat. no. 1.4404/316L
Seal diaphragm	Stainless steel, material no. 1.4404/316L or Alloy C276, material no. 2.4819
• Non-wetted parts materials	
Electronics housing	<ul style="list-style-type: none"> <li>• Low-copper die-cast aluminum GD-AISI 12 or stainless steel precision casting, mat. no. 1.4409/ CF-3M</li> <li>• Standard: Powder coating with polyurethane Option: 2 coats: Coat 1: epoxy-based; coat 2: Polyurethane</li> <li>• Stainless steel nameplate (1.4404/316L)</li> </ul>
Mounting bracket	Steel, galvanized, stainless steel 1.4301/304, stainless steel 1.4404/316L
Process connection	<ul style="list-style-type: none"> <li>• Connection pin G<sup>1</sup>/<sub>2</sub>A in accordance with DIN EN 837-1</li> <li>• Female thread <sup>1</sup>/<sub>2</sub>-14 NPT</li> <li>• Oval flange (MAWP 160 bar abs (2320 psi g) with fastening screw thread: <ul style="list-style-type: none"> <li>– <sup>7</sup>/<sub>16</sub>-20 UNF in accordance with EN 61518</li> <li>– M10 in accordance with DIN 19213</li> </ul> </li> <li>• Oval flange (MAWP 420 bar abs (MAWP 2320 psi g) with fastening screw thread: <ul style="list-style-type: none"> <li>– <sup>7</sup>/<sub>16</sub>-20 UNF in accordance with EN 61518</li> <li>– M12 in accordance with DIN 19213</li> </ul> </li> <li>• Male thread M20 x 1.5 and <sup>1</sup>/<sub>2</sub>-14 NPT</li> </ul>
Electrical connection	Cable inlet using the following screwed joints: <ul style="list-style-type: none"> <li>• M20 x 1.5</li> <li>• <sup>1</sup>/<sub>2</sub>-14 NPT</li> <li>• Han 7D/Han 8D connector<sup>1)</sup></li> <li>• M12 connector</li> </ul>

<sup>1)</sup> Han 8D is identical to Han 8U.

<b>Construction for gauge pressure, with flush mounted diaphragm</b>	
Weight (pressure transmitter without mounting flange)	Approx. 1.8 kg (3.9 lb) with aluminum enclosure Approx. 3.8 kg (8.3 lb) with stainless steel enclosure
Material	
• Wetted parts materials	
Process connection	Stainless steel, mat. no. 1.4404/316L
Seal diaphragm	Stainless steel, material no. 1.4404/316L or Alloy C276, material no. 2.4819
• Non-wetted parts materials	
Electronics housing	<ul style="list-style-type: none"> <li>• Low-copper die-cast aluminum GD-AISI 12 or stainless steel precision casting, mat. no. 1.4409/CF-3M</li> <li>• Standard: Powder coating with polyurethane D20 option: 2 coats: Coat 1: epoxy-based; coat 2: Polyurethane</li> <li>• Stainless steel nameplate (1.4404/316L)</li> </ul>
Mounting bracket	Steel, galvanized, stainless steel 1.4301/304, stainless steel 1.4404/316L

13.7 Construction

**Construction for gauge pressure, with flush mounted diaphragm**

Process connection	<ul style="list-style-type: none"> <li>• Flanges as per EN and ASME</li> <li>• F&amp;B and Pharma flange</li> <li>• BioConnect/BioControl</li> <li>• PMC style</li> </ul>
--------------------	---

Electrical connection	<p>Cable inlet using the following screwed joints:</p> <ul style="list-style-type: none"> <li>• M20x1.5</li> <li>• 1/2-14 NPTM</li> <li>• Han 7D/Han 8D connector<sup>1)</sup></li> <li>• M12 connector</li> </ul>
-----------------------	--

<sup>1)</sup> Han 8D is identical to Han 8U.

**Construction for gauge pressure and absolute pressure (from the differential pressure series), differential pressure and flow rate**

Weight	<p>Approx. 3.9 kg (8.5 lb) with aluminum enclosure</p> <p>Approx. 5.9 kg (13 lb) with stainless steel enclosure</p>
--------	---

**Material**

• Wetted parts materials

Seal diaphragm	Stainless steel, mat. no. 1.4404/316L, Alloy C276, mat. no. 2.4819, Monel 400, mat. no. 2.4360, tantalum or gold
Pressure caps and vents	Stainless steel, mat. no. 1.4408 to MAWP 160 bar, mat. no. 1.4571/316Ti for MAWP 420 bar, Alloy C22, 2.4602 or Monel 400, mat. no. 2.4360
O-ring	FKM (Viton) or optionally: PTFE, FEP, FEPM and NBR

• Non-wetted parts materials

Electronics housing	<ul style="list-style-type: none"> <li>• Low-copper die-cast aluminum GD-ALSi 12 or stainless steel precision casting, mat. no. 1.4409/CF-3M</li> <li>• Standard: Powder coating with polyurethane</li> <li>• D20 option: 2 coats: Coat 1: epoxy-based; coat 2: Polyurethane</li> <li>• Stainless steel nameplate (1.4404/316L)</li> </ul>
Pressure cap screws	Stainless steel ISO 3506-1 A4-70
Mounting bracket	Steel, galvanized, stainless steel 1.4301/304, stainless steel 1.4404/316L

Process connection	1/4-18 NPT female thread and flange connection with 7/16-20 UNF mounting thread in accordance with EN 61518 or M10 mounting thread in accordance with DIN 19213 (M12 for MAWP 420 bar (6092 psi))
--------------------	---

Electrical connection	<p>Screw terminals</p> <p>Cable inlet using the following screwed joints:</p> <ul style="list-style-type: none"> <li>• M20 x 1.5</li> <li>• 1/2-14 NPT</li> <li>• Han 7D/Han 8D connector<sup>1)</sup></li> <li>• M12 connector</li> </ul>
-----------------------	--

<sup>1)</sup> Han 8D is identical to Han 8U.

### Construction for level

#### Weight

- In accordance with EN (pressure transmitter with mounting flange, without tube) Approx. 11 ... 13 kg (24.2 ... 28.7 lb) with aluminum enclosure  
Approx. 13 ... 15 kg (28.7 ... 33 lb) with stainless steel enclosure
- In accordance with ASME (pressure transmitter with mounting flange, without tube) Approx. 11 ... 18 kg (24.2 ... 39.7 lb) with aluminum enclosure  
Approx. 13 ... 20 kg (28.7 ... 44 lb) with stainless steel enclosure

#### Material

- Wetted parts materials

##### Plus side

- Seal diaphragm on the mounting flange Stainless steel, mat. no. 1.4404/316L, Monel 400, mat. no. 2.4360, Alloy B2, mat. no. 2.4617, Alloy C276, mat. no. 2.4819, Alloy C22, mat. no. 2.4602, tantalum, PTFE
- Sealing surface Smooth as per EN 1092-1, form B1 or ASME B16.5 RF 125 ... 250 AA for stainless steel 316L, EN 2092-1 form B2 or ASME B16.5 RFSF for the remaining materials

##### Sealing material in the pressure caps

- For standard applications FKM (Viton)
- For underpressure applications on the mounting flange Copper

##### Minus side

- Seal diaphragm Stainless steel, mat. no. 1.4404/316L
- Pressure caps locking screws Stainless steel, mat. no. 1.4408
- Locking screw Stainless steel ISO 3506-1 A4-70
- O-ring FKM (Viton)

- Non-wetted parts materials

- Electronics housing
  - Low-copper die-cast aluminum GD-ALSi 12 or stainless steel precision casting, mat. no. 1.4409/CF-3M
  - Standard: Powder coating with polyurethane  
D20 option: 2 coats: Coat 1: epoxy-based; coat 2: Polyurethane
  - Stainless steel nameplate (1.4404/316L)

- Pressure cap screws Stainless steel ISO 3506-1 A4-70

- Measuring cell filling Silicone oil

- Mounting flange fill fluid Silicon oil or a different design

#### Process connection

- Plus side Flange as per EN and ASME

13.8 Torques

Construction for level	
• Minus side	<sup>1</sup> / <sub>4</sub> -18 NPT female thread and flange connection with mounting thread M10 in accordance with DIN 19213 (M12 for MAWP 420 bar (6092 psi)) or <sup>7</sup> / <sub>16</sub> -20 UNF in accordance with EN 61518
Electrical connection	<p>Screw terminals</p> <p>Cable inlet using the following screwed joints:</p> <ul style="list-style-type: none"> <li>• M20 x 1.5</li> <li>• <sup>1</sup>/<sub>2</sub>-14 NPT</li> <li>• Han 7D/Han 8D connector<sup>1)</sup></li> <li>• M12 connector</li> </ul>

<sup>1)</sup> Han 8D is identical to Han 8U.

## 13.8 Torques

Torques	
Connecting terminals	
• Connecting terminals in the connection compartment	1.5 Nm (1.1 ft lb)
• External ground terminal on enclosure	
Cable glands/blanking plugs	
• Screw-in torque for plastic gland in all enclosures	4 Nm (3 ft lb)
• Screw-in torque for metal/stainless steel glands in aluminum/stainless steel enclosure	6 Nm (4.4 ft lb)
• Screw-in torque for NPT adapter made of metal/stainless steel in aluminum/stainless steel enclosure	15 Nm (11.1 ft lb)
• Tightening torque for union nut made of plastic	2.5 Nm (1.8 ft lb)
• Tightening torque for union nut made of metal/stainless steel	4 Nm (3 ft lb)
Screws for mounting bracket (option)	
• Tightening torque for thread M8 or <sup>5</sup> / <sub>16</sub> -24 UNF	18 Nm (13.2 ft lb)
• Tightening torque for thread M10 or <sup>7</sup> / <sub>16</sub> -20 UNF	36 Nm (26.5 ft lb)
Retaining screws for rotation of the enclosure	
• Tightening torque for aluminum enclosure	3.8 Nm (2.8 ft lb)
• Tightening torque for stainless steel enclosure	3.5 Nm (2.5 ft lb)
Screws for safety catch	
• Tightening torque for aluminum enclosure	0.88 Nm (0.65 ft lb)

## 13.9 Display, keys and auxiliary power

Display and buttons		
Keys	4 buttons for operation directly on the device	
Display	<ul style="list-style-type: none"> <li>• With or without integrated display (optional)</li> <li>• Cover with glass pane (option)</li> </ul>	
Auxiliary power $U_H$		
	HART	PROFIBUS PA/FOUNDATION Fieldbus
Terminal voltage on pressure transmitter	<ul style="list-style-type: none"> <li>• DC 10.5 V ... 45 V</li> <li>• In the case of intrinsically safe operation 10.5 V ... 30 V DC</li> </ul>	-
Auxiliary power	-	Bus-powered
Separate supply voltage	-	-
Bus voltage		
• Not 	-	9 ... 32 V
• With intrinsically safe operation	-	9 ... 24 V
Current consumption		
• Max. basic current	-	12.5 mA
• Starting current $\leq$ basic current	-	Yes
• Max. current in event of fault	-	15.5 mA
Fault disconnection electronics (FDE) available	-	Yes
Overvoltage protection up to 6 kV (internal)		
Note	Devices with internal overvoltage protection up to 6 kV do not pass the high voltage test with 700 V DC according to IEC 60079-11. For further information, see the associated certificate for explosion protection.	

## 13.10 Certificates and approvals

Explosion protection in accordance with ATEX	HART	PROFIBUS PA/FOUNDATION Fieldbus
Certificate	BVS 18 ATEX E049X	
• Intrinsic safety "i"		

13.10 Certificates and approvals

Explosion protection in accordance with ATEX	HART	PROFIBUS PA/FOUNDATION Fieldbus
Designation	II 1/2 G Ex ia/ib IIC T4/T6 Ga/Gb II 2G Ex ib IIC T4/T6 Gb	II 1/2G Ex ia IIC T4/T6 Ga/Gb II 2G Ex ib IIC T4/T6 Gb II 3G Ex ic IIC T4/T6 Gc
Permissible ambient temperature	-40 ... +80 °C (-40 ... +176 °F) Temperature class T4 -40 ... +55 °C (-40 ... +158 °F) Temperature class T6	-40 ... +75 °C (-40 ... +167 °F) temperature class T4 -40 ... +50 °C (-40 ... +122 °F) temperature class T6
Permissible temperature of medium	-40 ... +100 °C (-40 ... +212 °F) temperature class T4 -40 ... +70 °C (-40 ... +158 °F) temperature class T6	
Connection	To a certified intrinsically safe circuit with the max. values: $U_i = 30 \text{ V}$ , $I_i = 101 \text{ mA}$ , $P_i = 760 \text{ mW}$ $U_i = 29 \text{ V}$ , $I_i = 110 \text{ mA}$ , $P_i = 800 \text{ mW}$	FISCO <ul style="list-style-type: none"> <li>ia/ib: <math>U_i = 17.5 \text{ V}</math>, <math>I_i = 380 \text{ mA}</math>, <math>P_i = 5.32 \text{ W}</math></li> <li>ic: <math>U_i = 17.5 \text{ V}</math>, <math>I_i = 570 \text{ mA}</math></li> </ul> <hr/> Linear barrier <ul style="list-style-type: none"> <li>ia/ib: <math>U_i = 24 \text{ V}</math>, <math>I_i = 174 \text{ mA}</math>, <math>P_i = 1.0 \text{ W}</math></li> <li>ic: <math>U_i = 32 \text{ V}</math>, <math>I_i = 132 \text{ mA}</math>, <math>P_i = 1.0 \text{ W}</math></li> </ul>
Effective inner capacitance	$C_i = 3.29 \text{ nF}$	$C_i = 1.1 \text{ nF}$
Effective inner inductance	$L_i = 0.24 \text{ }\mu\text{H}$	$L_i = 4.8 \text{ }\mu\text{H}$
• Flameproof enclosure encapsulation "d"		
Designation	II 1/2G Ex ia/db IIC T4/T6 Ga/Gb II 2G Ex db ia IIC T4/T6 Gb	
Permissible ambient temperature	-40 ... +80 °C (-40 ... +176 °F) temperature class T4 -40 ... +70 °C (-40 ... +158 °F) temperature class T6	
Permissible temperature of medium	-40 ... +100 °C (-40 ... +212 °F) temperature class T4 -40 ... +70 °C (-40 ... +158 °F) temperature class T6	
Connection	To a circuit with the operating values: $U_H = 10.5 \dots 45 \text{ V DC}$ , $4 \dots 20 \text{ mA}$	To a circuit with the operating values: $U_H = 10.5 \dots 24 \text{ V DC}$
• Dust explosion protection for zones 21, 22		
Designation	II 2D Ex tb IIIC T120 °C Db II 3D Ex tc IIIC T120 °C Dc	
Permissible ambient temperature	-40 ... +80 °C (-40 ... +176 °F)	
Permissible temperature of medium	-40 ... +100 °C (-40 ... +212 °F)	
Max. surface temperature	120°C (248°F)	
Connection	To a circuit with the operating values: $U_H = 10.5 \dots 45 \text{ V DC}$ , $4 \dots 20 \text{ mA}$	To a circuit with the operating values: $U_H = 10.5 \dots 24 \text{ V DC}$
• Dust explosion protection for Zone 20		

Explosion protection in accordance with ATEX		HART	PROFIBUS PA/FOUNDATION Fieldbus
Designation	II 1D Ex ia IIIC T120 °C Da		
Permissible ambient temperature	-40 ... +80 °C (-40 ... +176 °F)		-40 ... +75 °C (-40 ... +167 °F)
Permissible temperature of medium	-40 ... +100 °C (-40 ... +212 °F)		
Connection	To a certified intrinsically safe circuit with the max. values: $U_i = 30 \text{ V}$ , $I_i = 101 \text{ mA}$ , $P_i = 760 \text{ mW}$ $U_i = 29 \text{ V}$ , $I_i = 110 \text{ mA}$ , $P_i = 800 \text{ mW}$		FISCO <ul style="list-style-type: none"> <li>ia/ib: <math>U_i = 17.5 \text{ V}</math>, <math>I_i = 380 \text{ mA}</math>, <math>P_i = 5.32 \text{ W}</math></li> <li>ic: <math>U_i = 17.5 \text{ V}</math>, <math>I_i = 570 \text{ mA}</math></li> </ul> <hr/> Linear barrier <ul style="list-style-type: none"> <li>ia/ib: <math>U_i = 24 \text{ V}</math>, <math>I_i = 174 \text{ mA}</math>, <math>P_i = 1.0 \text{ W}</math></li> <li>ic: <math>U_i = 32 \text{ V}</math>, <math>I_i = 132 \text{ mA}</math>, <math>P_i = 1.0 \text{ W}</math></li> </ul>
Effective inner capacitance	$C_i = 3.29 \text{ nF}$	$C_i = 1.1 \text{ nF}$	
Effective inner inductance	$L_i = 0.24 \text{ } \mu\text{H}$	$L_i = 4.8 \text{ } \mu\text{H}$	

- Type of protection for Zone 2  
 A power supply unit of intrinsically safe protection type "Ex ia" in zone 2 is sufficient to connect devices of intrinsically safe protection type [Ex ic].

		II 3G Ex ec IIC T4/T6 Gc	
Permissible ambient temperature "ec"	-40 ... +80 °C (-40 ... +176 °F) temperature class T4		-40 ... +40 °C (-40 ... +104 °F) temperature class T6
Permissible temperature of medium	-40 ... +100 °C (-40 ... +212 °F) temperature class T4		-40 ... +70 °C (-40 ... +158 °F) temperature class T6
Connection "ec"	To a circuit with the operating values: $U_n = 10.5 \text{ to } 30 \text{ V}$ , $I_n = 4 \text{ ... } 20 \text{ mA}$	To a circuit with the operating values: $U_H = 10.5 \text{ ... } 24 \text{ V DC}$	

<b>Explosion protection in accordance with FM (USA)</b>	
FM19US0155X	The permissible operating values is specified in the certificate.
<b>Order variants</b>	<b>Identification</b>
7MF0..0-.....-B..-Z	Class I, Zone 0, AEx ia IIC T4/T6 Ga Class I, Zone 1, AEx ib IIC T4/T6 Gb Intrinsically Safe (IS) for Class I, DIV 1, Gr. A-D
7MF0..0-.....-C..-Z	Class I, Zone 0/1, AEx ia/db IIC T4/T6 Ga/Gb Explosion Proof (XP) for Class I, DIV 1, Gr. A-D
7MF0..0-.....-D..-Z	Class I, Zone 0, AEx ia IIC T4/T6 Ga Class I, Zone 0/1, AEx ia/db IIC T4/T6 Ga/Gb Intrinsically Safe (IS) for Class I, DIV 1, Gr. A-D Explosion Proof (XP) for Class I, DIV 1, Gr. A-D
7MF0..0-.....-L..-Z	Class II, Zone 21, AEx tb IIIC T120°C Db Class II, Zone 22, AEx tc IIIG T120°C Dc Class I, Zone 2, AEx ec IIC T4/T6 Gc Dust Ignition Proof (DIP) for Class II, DIV 2, Gr. E-G, Class III Non incendive (NI) for Class I, DIV 2, Gr. A-D
7MF0..0-.....-M..-Z	Class II, Zone 20, AEx ia IIIC T120°C Da Class I, Zone 0, AEx ia IIC T4/T6 Ga Class II, Zone 21, AEx tb IIIC T120°C Db Class I, Zone 2, AEx ec IIC T4/T6 Gc Intrinsically Safe (IS) for Class II, DIV 1, Gr. E-G; Class III Intrinsically Safe (IS) for Class I, DIV 1 Gr. A-D Dust Ignition Proof (DIP) for Class II, DIV 2, Gr. E-G; Class III Non incendive (NI) for Class I, DIV 2, Gr. A-D
7MF0..0-.....-S..-Z	Class I, Zone 0/1, AEx ia/db IIC T4/T6 Ga/Gb Class I, Zone 0, AEx ia IIC T4/T6 Ga Class II, Zone 21, AEx tb IIIC T120°C Db Class I, Zone 2, AEx ec IIC T4/T6 Gc
7MF0..0-.....-T..-Z	Class I, Zone 0/1, AEx ia/db IIC T4/T6 Ga/Gb Class I, Zone 0, AEx ia IIC T4/T6 Ga Class II, Zone 21, AEx tb IIIC T120°C Db Class I, Zone 2, AEx ec IIC T4/T6 Gc Explosion proof (XP) for Class I, DIV 1 Gr. A-D Intrinsically Safe (IS) for Class I, DIV 1 Gr. A-D Dust ignition proof (DIP) for Class II, DIV 2, Gr. E-G; Class III Non-incendive (NI) for Class I, DIV 2, Gr. A-D



---

**Explosion protection in accordance with FM (USA)**

---

**Special conditions for use**

- For type of protection "db": When you use the device as partition wall device in zones that require EPL Ga, isolate the non-intrinsically safe circuit safely from ground, e.g.: through a SELV circuit.
  - For type of protection "ec": Isolate the non-intrinsically safe circuit safely from ground, e.g.: through a SELV circuit that ensures transient protection up to 140% of the nominal voltage.
  - Mount the device so that the enclosure is not exposed to any intense electrostatic charging processes.
  - To prevent electrostatic charging in hazardous areas, clean the outside of the enclosure using a cloth moistened with water.
- 

---

**Explosion protection in accordance with cCSAus (Canada/USA)**

---

CSA18CA70163103X	The permissible operating values can be found in the certificate.	
Marking (XP/DIP) or (IS); (NI)	According to CSA Standards	Ex ia/db IIC T4/T6 Ga/Gb Ex ia IIC T4/T6 Ga Ex ia IIIC T120°C Da Ex tb IIIC T120°C Db Ex ec IIC T4/T6 Gc Class I, DIV 1, Gr. A-D (Explosion Proof) Intrinsically Safe (IS) for Class I, DIV 1, Gr. A-D (Intrinsically Safe (IS)) Class II, DIV 2, Gr. E-G; Class III Class I, DIV 2, Gr. A-D (NI)
	According to US Standards	Class I, Zone 0/1, AEx ia/db IIC T4/T6 Ga/Gb Class I, Zone 0, AEx ia IIC T4/T6 Ga Zone 20, AEx ia IIIC T120°C Da Zone 21, A/Ex tb IIIC T120°C Db Class I, Zone 2, AEx ec IIC T4/T6 Gc Class I, DIV 1 Gr. A-D (Explosion proof (XP)) Class I, DIV 1 Gr. A-D (Intrinsically Safe (IS)) Class II, DIV 2, Gr. E-G; Class III Class I, DIV 2, Gr. A-D (NI)

---

**Further certificates for explosion protection**

Explosion protection in accordance with NEPSI (China) GYJ19.1058X	The permissible operating values and markings can be found in the certificate.
Explosion protection in accordance with INMETRO (Brazil) BRA-18-GE-0035X	
Explosion protection in accordance with EAC (Russia) TC RU C-DE.AA87.B.01202	
Explosion protection in accordance with IECEx IECEx BVS 18.0038X	

---



## Dimension drawings

### 14.1 SITRANS P320/P420 for gauge pressure and absolute pressure from the gauge pressure series

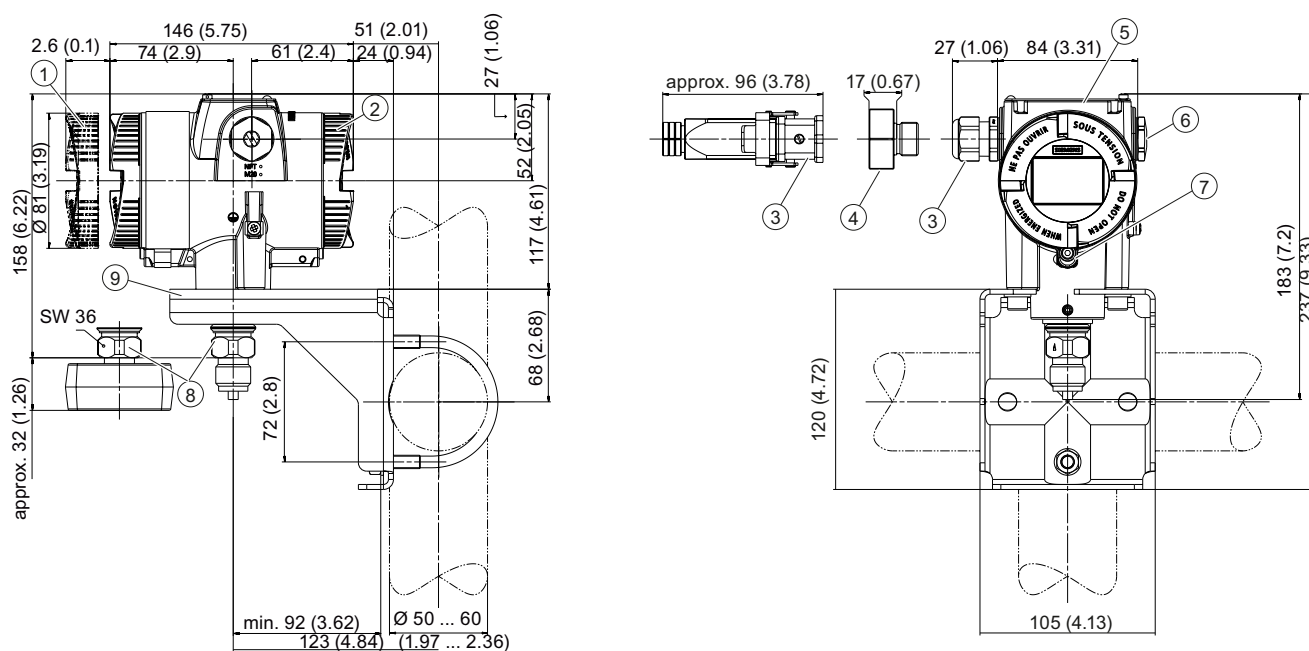

- ① Electronics side, display  
(longer for cover with glass pane)<sup>1)</sup>
- ② Connection end
- ③ Electrical connection:
  - M20 x 1.5 gland<sup>3)</sup>
  - ½-14 NPT gland
  - Han 7D/Han 8D plug<sup>2) 3)</sup>
  - M12 connector<sup>2)3)</sup>
- ④ Harting adapter
- ⑤ Cover over buttons and nameplate with general information
- ⑥ Blanking plug
- ⑦ Safety catch  
(only for flameproof enclosure)
- ⑧ Process connection: G½B connection pin or oval flange
- ⑨ Mounting bracket (optional)

<sup>1)</sup> In addition, allow approx. 22 mm (0.87 inches) for the thread length when removing the covers

## *Dimension drawings*

---

### *14.1 SITRANS P320/P420 for gauge pressure and absolute pressure from the gauge pressure series*

2) Not with "flameproof enclosure" type of protection

3) Not for "FM + CSA [is + XP]" type of protection

Figure 14-1 SITRANS P320 and SITRANS P420 pressure transmitters for absolute pressure, from the gauge pressure series, dimensions in mm (inches)

14.2 SITRANS P320/P420 for differential pressure, gauge pressure, flow and absolute pressure from the differential pressure series

## 14.2 SITRANS P320/P420 for differential pressure, gauge pressure, flow and absolute pressure from the differential pressure series

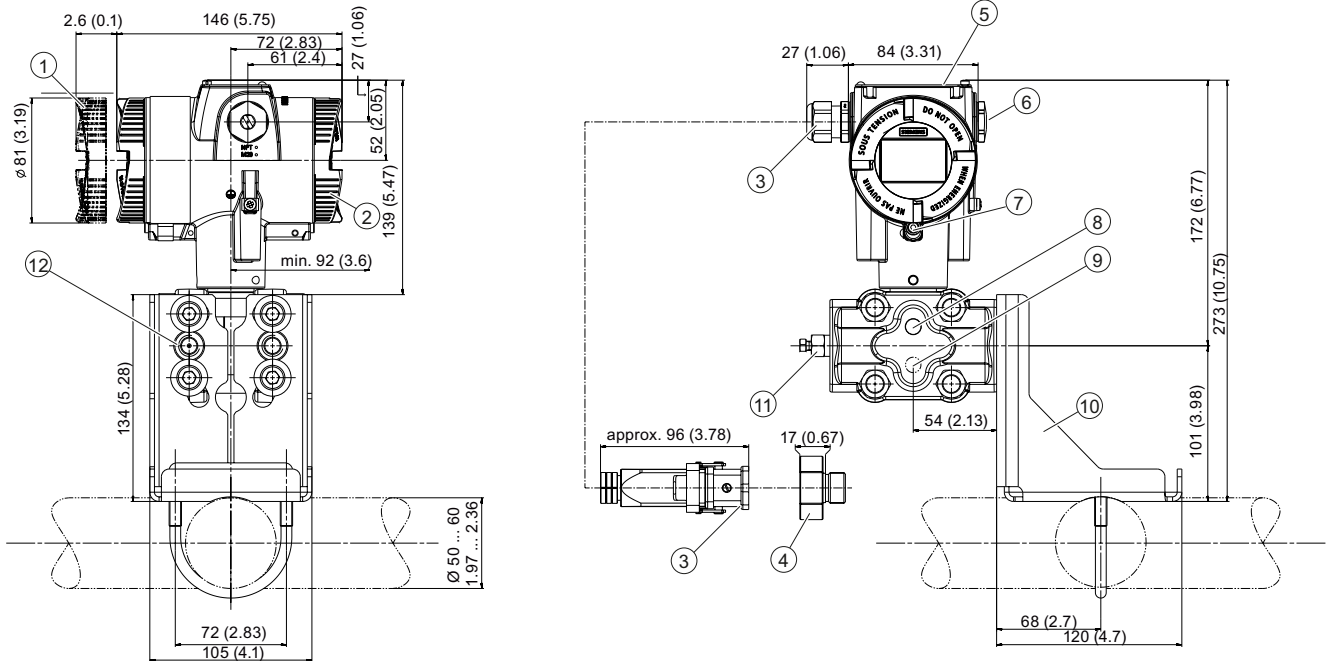

- ① Electronics side, display  
(longer for cover with glass pane)<sup>1)</sup>
- ② Connection end
- ③ Electrical connection:
  - M20 x 1.5 gland
  - ½-14 NPT gland
  - Han 7D/Han 8D plug<sup>2) 3)</sup>
  - M12 connector<sup>2)3)</sup>
- ④ Harting adapter
- ⑤ Cover over buttons and nameplate with general information
- ⑥ Blanking plug
- ⑦ Safety catch  
(only for "flameproof enclosure" type of protection)
- ⑧ Lateral ventilation for liquid measurement (standard)
- ⑨ Lateral ventilation for gas measurement (order option "K85")
- ⑩ Mounting bracket (optional)
- ⑪ Sealing plug, with valve (optional)
- ⑫ Process connection: ¼-18 NPT (EN 61518)

<sup>1)</sup> In addition, allow approx. 22 mm (0.87 inch) for the thread length when removing the covers

<sup>2)</sup> Not with "flameproof enclosure" type of protection

<sup>3)</sup> Not for "FM + CSA [IS + XP]" type of protection

Dimension drawings

14.2 SITRANS P320/P420 for differential pressure, gauge pressure, flow and absolute pressure from the differential pressure series

Figure 14-2 SITRANS P320 and SITRANS P420 pressure transmitters for differential pressure and flow, dimensions in mm (inches)

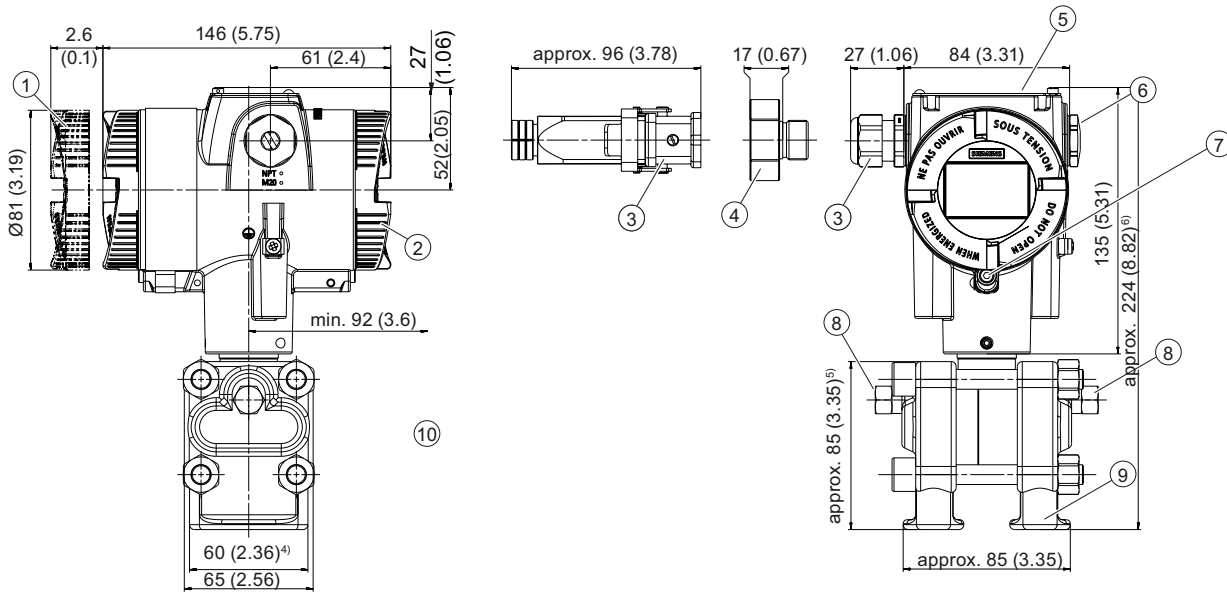

- ① Electronics side, display (longer for cover with inspection window)<sup>1)</sup>
- ② Connection end
- ③ Electrical connection:
  - M20 x 1.5 gland
  - 1/2-14 NPT gland
  - Han 7D/Han 8D plug<sup>2)3)</sup>
  - M12 connector<sup>2)3)</sup>
- ④ Harting adapter
- ⑤ Cover over buttons and nameplate with general information
- ⑥ Blanking plug
- ⑦ Safety catch (only for "flameproof enclosure" type of protection)
- ⑧ Sealing plug, with valve (optional)
- ⑨ Process connection: 1/4-18 NPT (IEC 61518)
- ⑩ Clearance for rotating the enclosure

1) In addition, allow approx. 22 mm (0.87 inches) for the thread length when removing the covers

2) Not with "flameproof enclosure" type of protection

3) Not for "FM + CSA [is + XP]" type of protection

4) 74 mm (2.9 inches) for PN ≥ 420 (MAWP ≥ 6092 psi)

5) 91 mm (3.6 inches) for PN ≥ 420 (MAWP ≥ 6092 psi)

6) 226 mm (8.62 inches) for PN ≥ 420 (MAWP ≥ 6092 psi)

Figure 14-3 SITRANS P320 and SITRANS P420 pressure transmitters for differential pressure and flow with process flanges for vertical differential pressure lines (order option "K81"), dimensions in mm (inches)

### 14.3 SITRANS P 320/P420 for level

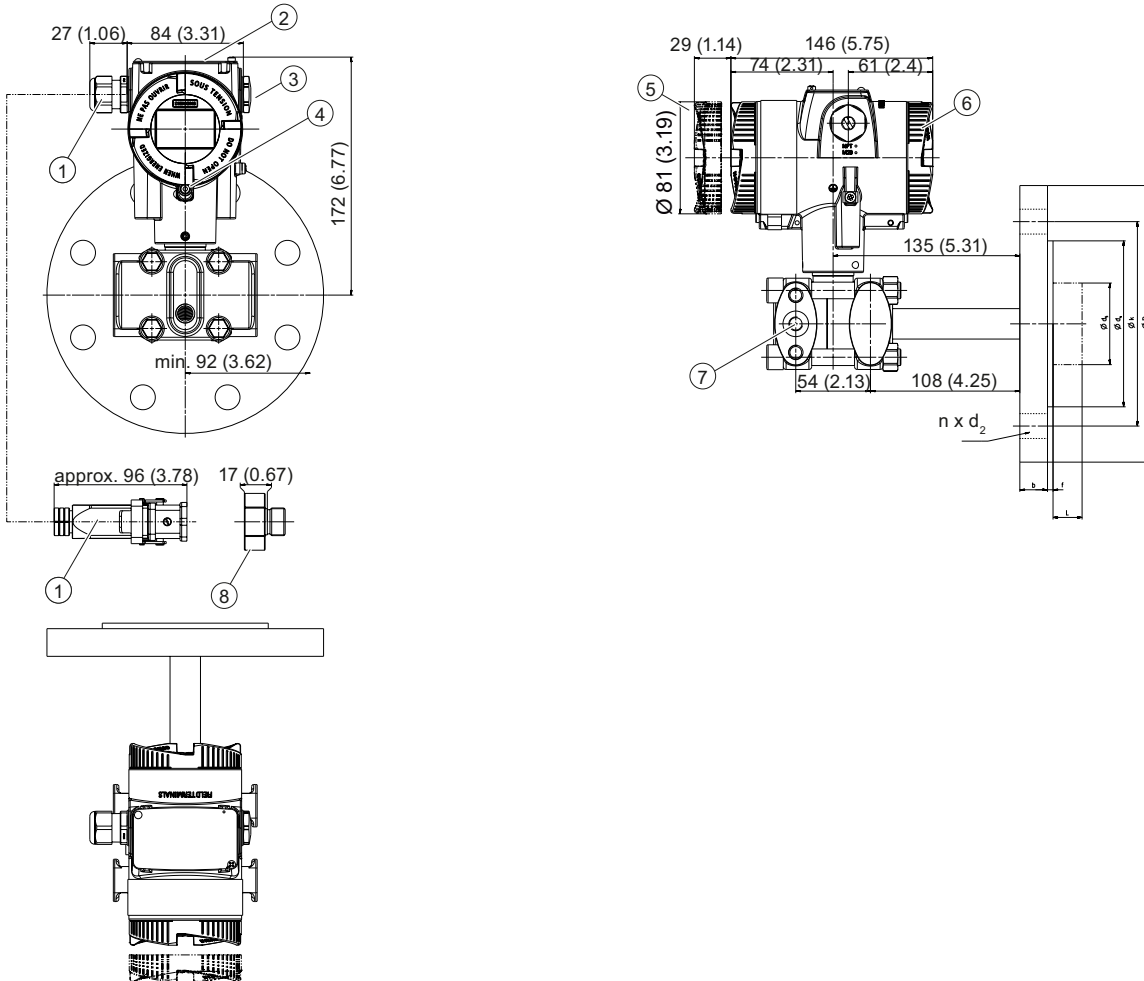

- ① Electrical connection:
  - M20 x 1.5 gland
  - ½-14 NPT gland
  - Han 7D/Han 8D plug<sup>2) 3)</sup>
  - M12 connector<sup>2) 3)</sup>
- ② Cover over buttons and nameplate with general information
- ③ Blanking plug
- ④ Safety catch  
(only for "flameproof enclosure" type of protection)
- ⑤ Connection end
- ⑥ Electronics side, display  
(longer for cover with glass pane)<sup>1)</sup>
- ⑦ Locking screw
- ⑧ Harting adapter

<sup>1)</sup> In addition, allow approx. 22 mm (0.87 inches) for the thread length when removing the covers

14.4 SITRANS P320/P420 (front-flush)

- 2) Not with "flameproof enclosure" type of protection
- 3) Not for "FM + CSA [is + XP]" type of protection

Figure 14-4 SITRANS P320 and SITRANS P420 pressure transmitters for level, including mounting flange, dimensions in mm (inches)

14.4 SITRANS P320/P420 (front-flush)

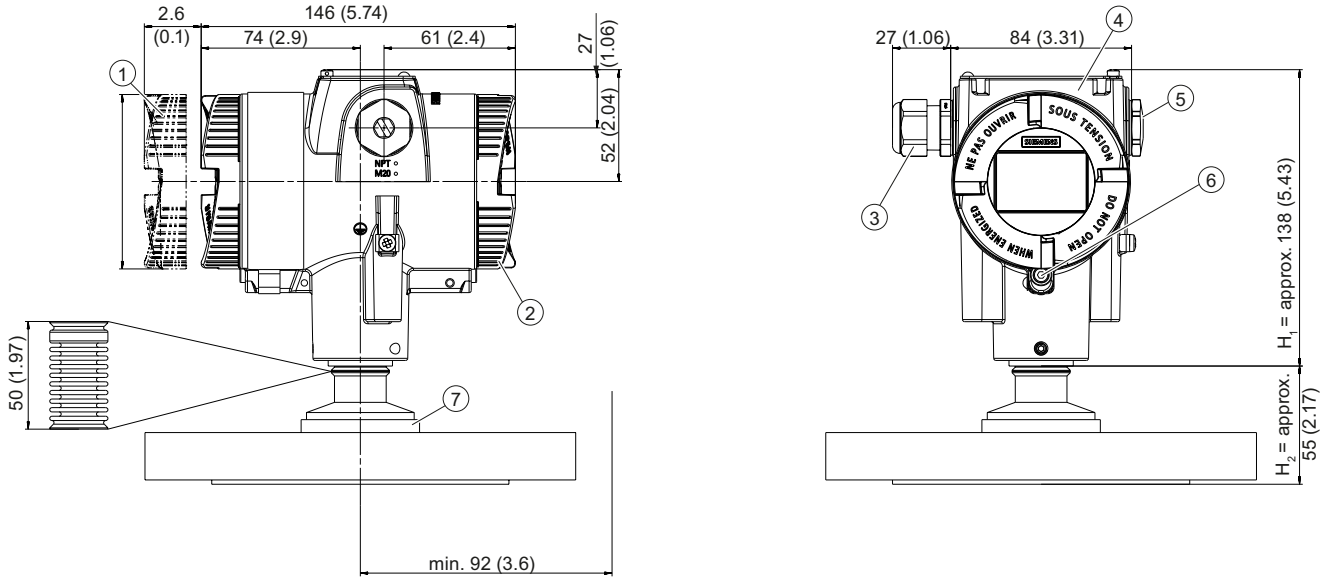

- ① Electronics side, display (longer for cover with glass pane)<sup>1)</sup>
- ② Connection end
- ③ Electrical connection:
  - M20 x 1.5 gland
  - 1/2-14 NPT gland
  - Han 7D/Han 8D plug<sup>2) 3)</sup>
  - M12 connector<sup>2)3)</sup>
- ④ Cover over buttons and nameplate with general information
- ⑤ Blanking plug
- ⑥ Safety catch (only for "flameproof enclosure" type of protection)
- ⑦ Process connection

1) In addition, allow approx. 22 mm (0.87 inches) for the thread length when removing the covers  
 2) Not with "flameproof enclosure" type of protection  
 3) Not for "FM + CSA [is + XP]" type of protection

Figure 14-5 SITRANS P320 and SITRANS P420 pressure transmitters (front-flush), dimensions in mm (inches)



### 14.4.1 Note 3A and EHDG

#### Note

#### Approvals

The references to the approvals for "EHEDG" and "3A" refer to the respective process connections and are not device-specific. Please refer to the technical specifications of the respective pressure transmitter to see whether the desired certificate is available for your device/flange combination.

### 14.4.2 Connections as per EN and ASME

#### Flange according to EN

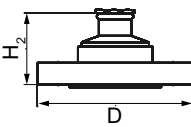
EN 1092-1				
	DN	PN	∅D	H <sub>2</sub>
	25	40	115 mm (4.5")	Approx. 52 mm (2")
	40	40	150 mm (5.9")	
	40	100	170 mm (6.7")	
	50	16	165 mm (6.5")	
	50	40	165 mm (6.5")	
	80	16	200 mm (7.9")	
	80	40	200 mm (7.9")	

#### Threaded connections

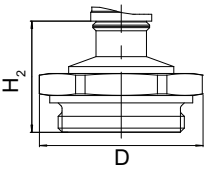
G3/4", G1" and G2" In accordance with DIN 3852				
	DN	PN	∅D	H <sub>2</sub>
	3/4"	60	37 mm (1.5")	approx. 45 mm (1.8")
	1"	60	48 mm (1.9")	approx. 47 mm (1.9")
	2"	60	78 mm (3.1")	Approx. 52 mm (2")

### Flange according to ASME

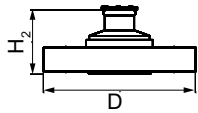
ASME B 16.5				
	DN	CLASS	ØD	H <sub>2</sub>
	1"	150	110 mm (4.3")	Approx. 52 mm (2")
	1½"	150	125 mm (4.9")	
	1½"	300	155 mm (6.1")	
	2"	150	150 mm (5.9")	
	2"	300	165 mm (6.5")	
	3"	150	190 mm (7.5")	
	3"	300	210 mm (8.1")	
	4"	150	230 mm (9.1")	
	4"	300	255 mm (10.0")	

### 14.4.3 F&B and pharma flange

#### Connections as per DIN

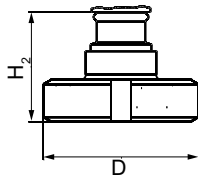
DIN 11851				
	DN	PN	ØD	H <sub>2</sub>
	50	25	92 mm (3.6")	Approx. 52 mm (2")
	80	25	127 mm (5.0")	

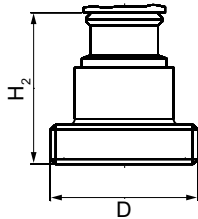
DIN 11864-1 Form A - sterile threaded sockets				
	DN	PN	ØD	H <sub>2</sub>
	50	25	78 mm (2")	Approx. 52 mm (2")
	65	25	95 mm (3.7")	
	80	25	110 mm (4.3")	
	100	25	130 mm (5.1")	
Approvals	EHEDG			

**DIN 11864-2 Form A - sterile collar flange**

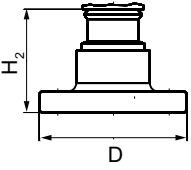
	DN	PN	ØD	H <sub>2</sub>
	50	16	94 mm (3.7")	Approx. 52 mm (2")
	65	16	113 mm (4.4")	
	80	16	133 mm (5.2")	
	100	16	159 mm (6.3")	

Approvals EHEDG

**DIN 11864-2 Form A - sterile groove flange**

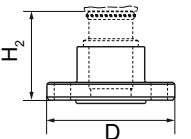
	DN	PN	ØD	H <sub>2</sub>
	50	16	94 mm (3.7")	Approx. 52 mm (2")
	65	16	113 mm (4.4")	
	80	16	133 mm (5.2")	
	100	16	159 mm (6.3")	

Approvals EHEDG

**DIN 11864-3 Form A - sterile collar sockets**

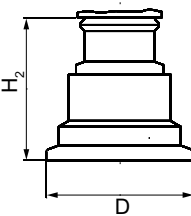
	DN	PN	ØD	H <sub>2</sub>
	50	25	77.5 mm (3.1")	Approx. 52 mm (2")
	65	25	91 mm (3.6")	
	80	16	106 mm (4.2")	
	100	16	130 mm (5.1")	

Approvals EHEDG

**Tri-Clamp as per DIN 32676**

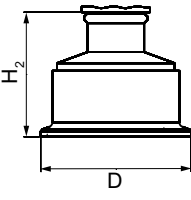
	DN	PN	ØD	H <sub>2</sub>
	50	16	64 mm (2.5")	Approx. 52 mm (2")
	65	16	91 mm (3.6")	
	2"	16	64 mm (2.5")	
	3"	10	91 mm (3.6")	

Other connections

Varivent® connector				
	DN	PN	∅D	H <sub>2</sub>
	40-125	40	84 mm (3.3")	Approx. 52 mm (2")

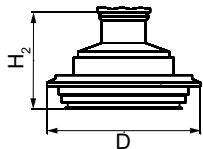

Approvals	EHEDG			
-----------	-------	--	--	--

Connection in accordance with DRD				
	DN	PN	∅D	H <sub>2</sub>
	65	40	105 mm (4.1")	Approx. 52 mm (2")

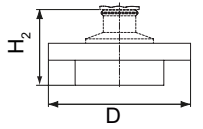

14.4.4 PMC Style

Connections for the paper industry

PMC Style Standard				
	DN	PN	∅D	H <sub>2</sub>
	-	-	40.9 mm (1.6")	Approx. 36.8 mm (1.4")
	M44x1.25 cap nut			

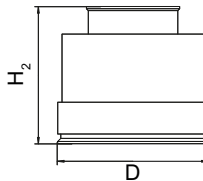

PMC-Style Minibolt				
	DN	PN	∅D	H <sub>2</sub>
	–	–	26.3 mm (1.0")	Approx. 33.1 mm (1.3")

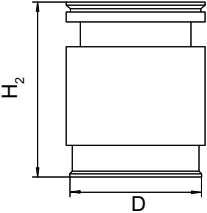

The drawing shows a cross-section of a minibolt with a square body and a hexagonal head. Dimension H<sub>2</sub> is the height of the square body, and D is the diameter of the square body.

### 14.4.5 Special connections

#### Tank connection

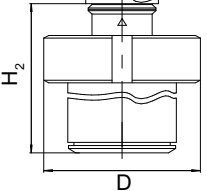
TG52/50 and TG52/150				
	DN	PN	∅D	H <sub>2</sub>
	TG52/50			
	25	40	63 mm (2.5")	Approx. 63 mm (2.5")
	TG52/150			
	25	40	63 mm (2.5")	Approx. 170 mm (6.7")

#### SMS connectors

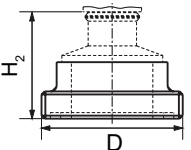
SMS threaded sockets				
	DN	PN	∅D	H <sub>2</sub>
	2"	25	70 x 1/6 mm (2.8")	Approx. 52 mm (2.1")
	2½"	25	85 x 1/6 mm (3.3")	
	3"	25	98 x 1/6 mm (3.9")	



# Product documentation and support

## A.1 Product documentation

Process instrumentation product documentation is available in the following formats:

- Certificates (<http://www.siemens.com/processinstrumentation/certificates>)
- Downloads (firmware, EDDs, software) (<http://www.siemens.com/processinstrumentation/downloads>)
- Catalog and catalog sheets (<http://www.siemens.com/processinstrumentation/catalogs>)
- Manuals (<http://www.siemens.com/processinstrumentation/documentation>)  
You have the option to show, open, save, or configure the manual.
  - "Display": Open the manual in HTML5 format
  - "Configure": Register and configure the documentation specific to your plant
  - "Download": Open or save the manual in PDF format
  - "Download as html5, only PC": Open or save the manual in the HTML5 view on your PC

You can also find manuals with the Mobile app at Industry Online Support (<https://support.industry.siemens.com/cs/ww/de/sc/2067>). Download the app to your mobile device and scan the device QR code.

### Product documentation by serial number

Using the PIA Life Cycle Portal, you can access the serial number-specific product information including technical specifications, spare parts, calibration data, or factory certificates.

#### Entering a serial number

1. Open the PIA Life Cycle Portal (<https://www.pia-portal.automation.siemens.com>).
2. Select the desired language.
3. Enter the serial number of your device. The product documentation relevant for your device is displayed and can be downloaded.

To display factory certificates, if available, log in to the PIA Life Cycle Portal using your login or register.

#### Scanning a QR code

1. Scan the QR code on your device with a mobile device.
2. Click "PIA Portal".

To display factory certificates, if available, log in to the PIA Life Cycle Portal using your login or register.

## A.2 Technical support

### Technical support

If this documentation does not completely answer your technical questions, you can enter a Support Request (<http://www.siemens.com/automation/support-request>).

Additional information on our technical support can be found at Technical Support (<http://www.siemens.com/automation/csi/service>).

### Service & support on the Internet

In addition to our technical support, Siemens offers comprehensive online services at Service & Support (<http://www.siemens.com/automation/serviceandsupport>).

### Contact

If you have further questions about the device, contact your local Siemens representative at Personal Contact (<http://www.automation.siemens.com/partner>).

To find the contact for your product, go to "all products and branches" and select "Products & Services > Industrial automation > Process instrumentation".

Contact address for business unit:

Siemens AG  
Digital Industries  
Process Automation  
Östliche Rheinbrückenstr. 50  
76187 Karlsruhe, Germany



# Remote operation

## B.1 SIMATIC PDM

### B.1.1 Overview SIMATIC PDM

SIMATIC PDM (Process Device Manager) is a general-purpose, manufacturer-independent tool for the configuration, parameter assignment, commissioning, diagnostics and maintenance of intelligent field devices and field components. Follow-up installations and additional information on SIMATIC PDM are available on the Internet at SIMATIC PDM ([www.siemens.com/simatic-pdm](http://www.siemens.com/simatic-pdm)).

SIMATIC PDM monitors the process values, alarms and status signals of the device. It allows you to display, compare, adjust, verify, and simulate process device data; also to set schedules for calibration and maintenance.

For information on, for example, how to install and integrate devices, commission the software, see Operating Manual 'Help for SIMATIC PDM'. The manual is delivered with SIMATIC PDM software. Once the SIMATIC PDM is installed on your computer you find the manual under: Start > All programs > Siemens Automation > SIMATIC > Documentation. Link at our website: SIMATIC PDM instructions and manuals (<https://support.industry.siemens.com/cs/ww/en/ps/16983/man>).

---

#### Note

##### Field device parameters

- For a list of parameters and additional information, consult section "Parameter assignment (Page 103)".
  - The field device remains in measurement mode during the time you configure the field device.
- 

### B.1.2 Check SIMATIC PDM version

#### Procedure

1. Go to SIMATIC PDM download (<http://www.siemens.com/simaticpdm/downloads>).
2. Check the support page to make sure you have:
  - The latest version of SIMATIC PDM
  - The most recent Service Pack (SP)
  - The most recent hot fix (HF)

### B.1.3 Deactivate buffers when connecting via serial modem

#### Introduction

This deactivation is required to align SIMATIC PDM with the HART modem when using a Microsoft Windows operating systems.

Deactivating buffers is not necessary when connecting via USB.

#### Condition

- You connect via RS232 (COM1).
- You have administrative rights on your operating system.
- You know the hardware and software requirements SIMATIC PDM installation documentation.

#### Procedure

1. Check the Operating Instructions for SIMATIC PDM for hardware and software requirements.
2. From the computer desktop, click "Start > Control Panel" to begin configuration.
3. Click "System and Security".
4. Select "Device Manager" under "System".
5. Open folder "Ports".
6. Double click the COM Port used by the system to open the properties window.
7. Select the tab "Port Settings".
8. Click the "Advanced" button.  
If the "Use FIFO buffers" radio box is selected, click to deselect.

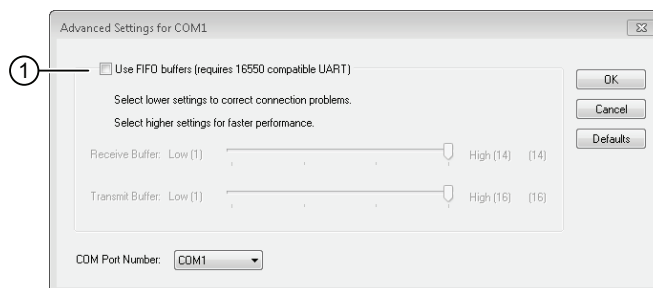

- ① Deselect "Use FIFO buffers" radio box

9. Click "OK" button to close out.
10. Close all screens.
11. Restart the computer.

## B.1.4 Updating the Electronic Device Description (EDD)

### Procedure

1. Check that the EDD revision match the Firmware revision in the device according to the table in section Product compatibility (Page 16).
2. Go to the support page Software downloads (<https://www.siemens.com/processinstrumentation/downloads>).
3. Enter the product name in the field "Enter search term...".
4. Download the most current EDD of your device.
5. Save files to your computer in an easily accessed location.
6. Launch SIMATIC PDM – Device Integration Manager.  
From the File menu, click "Read device descriptions from compressed source...".
7. Browse to the zipped EDD file, select and open it.
8. Use the "Integration" function to integrate the EDD into the device catalog. The EDD is now accessible via SIMATIC Manager.



## Checklist for Functional Safety

Step 1: User PIN	
Change preset user PIN 2457	• Yes
• Setting range: 1 to 65535	• No

Step 2: Validate values using the "Functional Safety" wizard	Values for the validation	Enter validated value
① Device identification data (if Functional Safety is enabled via remote operation) <ul style="list-style-type: none"> <li>• Long tag</li> <li>• Product name</li> <li>• Serial number</li> </ul>	The values can be found on the nameplate of the device and are displayed via the wizard.	
② Safety-related parameters		
S1 Primary variable	Pressure (the parameter cannot be changed)	
S2 Damping value	0.01 s ... 100 s in increments of 0.01 s	
S3 Upper range value	The value is within the measuring limits. You can find information on the nameplate of the device or in the section Technical data (Page 211)	
S4 Lower range value	The value is within the measuring limits. You can find information on the nameplate of the device or in the section Technical data (Page 211)	
S5 Application	<ul style="list-style-type: none"> <li>• Linear, proportional to pressure (PRESS).</li> <li>• Linear, proportional to level (LEVEL).</li> <li>• Proportional to flow rate, two-step linear up to the application point (VSLN2 or MSLN2).</li> </ul>	
S6 Overload behavior	Alarm or warning	
S7 Upper saturation limit	Between 20 mA and the upper fault current	
③ Fingerprint (only if Functional Security is enabled via remote operation)	The value is displayed using the "Functional Safety" wizard.	

Checklist for Functional Safety

---

<b>Step 3: Safety function</b>	
Validate the safety function using the "Functional Safety" wizard	<ul style="list-style-type: none"><li>• Yes</li><li>• No</li></ul>
Enter the date of validation of the safety function	

<b><i>Date when Functional Safety was enabled</i></b>	<b><i>Signature</i></b>

## Sealing plug / thread adapter

### D.1 Intended use of accessory part

The sealing plug and the thread adapter (components) can be used for installation in electrical equipment of flameproof "Ex d" type of protection of groups IIA, IIB, IIC as well as dust protection by enclosure "Ex t" type of protection.

### D.2 Safety instructions for accessory part

<p> <b>WARNING</b></p> <p><b>Incorrect assembly</b></p> <ul style="list-style-type: none"> <li>• The component can be damaged or destroyed or its functionality impaired through incorrect assembly.             <ul style="list-style-type: none"> <li>– Mount the component using a suitable tool. Refer to the information in Chapter "Technical specifications of accessory part (Page 280)", for example, torques for installation.</li> </ul> </li> <li>• For "Explosion-proof Ex d" type of protection: To ensure an engagement depth of 8 mm, the enclosure must have a wall thickness of at least 10 mm.</li> </ul> <p><b>Improper modifications</b></p> <p>Danger to personnel, system and environment can result from modifications and repairs of the component, particularly in hazardous areas.</p> <ul style="list-style-type: none"> <li>• Any modification which deviates from the delivery state is not permitted.</li> </ul> <p><b>Loss of enclosure type of protection</b></p> <p>IP protection is not guaranteed without sealant.</p> <ul style="list-style-type: none"> <li>• Use a suitable thread sealant.</li> <li>• If you are using the component in type of protection dust protection by enclosure "Ex t", use the supplied sealing ring (①, figure in Chapter "Dimensional drawings for accessory part (Page 281)").</li> </ul> <p><b>Unsuitable fluids in the environment</b></p> <p>Danger of injury or damage to device.</p> <p>Aggressive media in the environment can damage the sealing ring. Type of protection and device protection may no longer be guaranteed.</p> <ul style="list-style-type: none"> <li>• Make sure that the sealing material is suitable for the area of use.</li> </ul>
---

**Note****Loss of type of protection**

Changes in the ambient conditions can loosen the component.

- As part of the recommended maintenance intervals: Check the compression fitting for tight fit and tighten, if necessary.

## D.3 Technical specifications of accessory part

### Technical specifications sealing plug and thread adapter

Sealing plug suitable for types of protection	Explosion-proof enclosure "d" of groups IIA, IIB, IIC Dust protection by enclosure "t"
Standard compliance	The components meet Directive 94/9. They meet the requirements of standards IEC/EN 60079-0; IEC/EN 60079-1; IEC/EN 60079-31.
Explosion protection	
• Gas explosion protection	II2G Ex d IIC
• Dust explosion protection	II1D Ex t IIIC
Certificates	IECEX TUN 13.0022 U TÜV 13 ATEX 121710 U
Material for sealing plug / thread adapter	Stainless steel
Material for seal	Vulcanized fiber or Victor Reinz AFM 30
Ambient temperature range	-40 ... +100 °C (-40 ... +212 °F)
For "Ex d" type of protection: Required wall thickness for tapings	10 mm
Torque	
• For thread size M20 x 1.5	65 Nm
• For thread size M25 x 1.5	95 Nm
• For thread size ½-14 NPT	65 Nm
Width A/F for thread size M20 x 1.5	27
Width A/F for thread size M25 x 1.5	30
Key size for thread size ½-14 NPT	10



## D.4 Dimensional drawings for accessory part

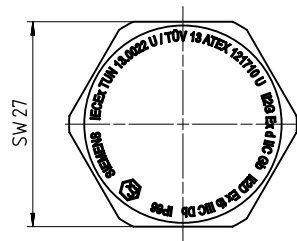
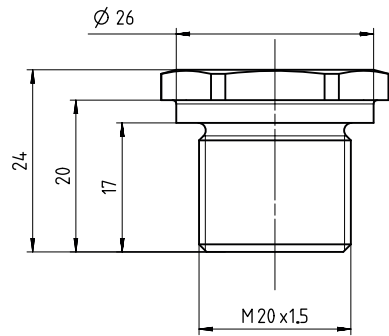

Sealing plug Ex d, M20 x 1.5, dimensions in mm

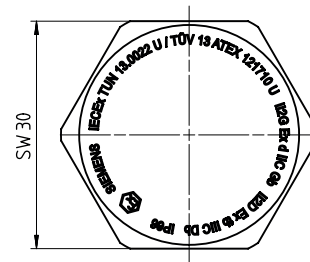
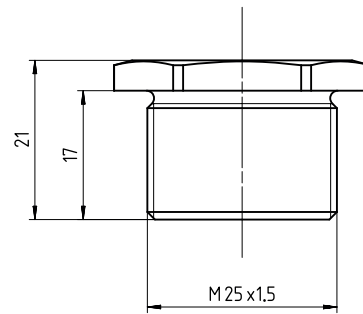

Sealing plug Ex d, M25 x 1.5, dimensions in mm

Sealing plug / thread adapter

D.4 Dimensional drawings for accessory part

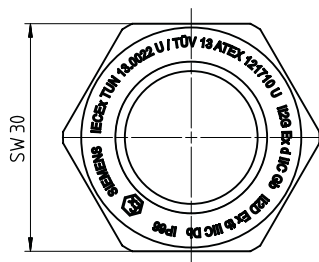
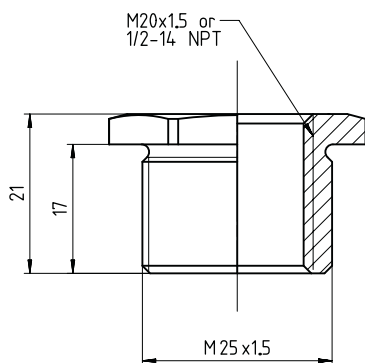

Thread adapter Ex d, M25 x 1.5 on M20 x 1.5 and M25 x 1.5 on 1/2-14 NPT, dimensions in mm

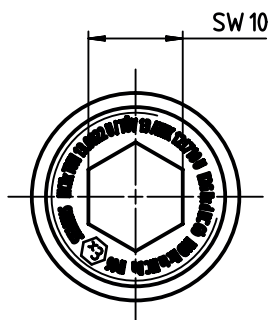
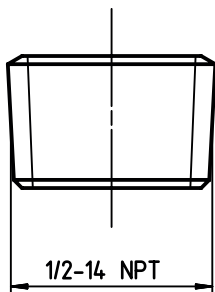

Sealing plug Ex d 1/2 -14 NPT

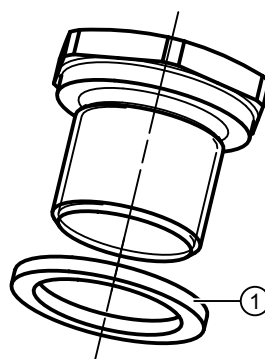

① Sealing ring: Use for dust protection "Ex t" type of protection.

# Abbreviations

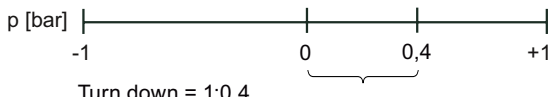
Abbreviation	In full	Meaning
PED	Pressure Equipment Directive	
GSD	General Station Description	Electronically readable ASCII text file which contains both general and device-specific parameters for communication and network configuration.
HART	Highway Addressable Remote Transducer	Standardized protocol for transmission of information between field device and automation system.
LRL	Lower Range Limit	Lower end of the measuring range
LRV	Lower Range Value	Lower end of the set measuring span
MA	Lower range value	Lower end of the set measuring span
ME	Upper range value	Upper end of the set measuring span
MAWP	Maximum Allowable Working Pressure (PS)	Maximum permissible operating pressure
NFPA	National Fire Protection Association	US - American Fire Protection Organization
F&B	Food and beverage industry	
<i>r</i>	Turndown	<p>Ratio of the set measuring span to the maximum set measuring span, for example</p>  <p>Set measuring span: 0.4 bar Maximum configured measuring span: 1 bar</p>
URL	Upper Range Limit	Upper end of the measuring range
URV	Upper Range Value	Upper end of the set measuring span



# Glossary

## ATEX

ATEX is an abbreviation of the French term "Atmosphère explosible" (potentially explosive atmosphere). ATEX stands for both EC directives in the area of explosion protection: ATEX product directive 94/9/EC and ATEX operating directive 1999/92/EC.

## Auxiliary power supply

Auxiliary power supply refers to an electrical supply or reference voltage which some electrical circuits require apart from the standard supply. The auxiliary power supply can, for example, be specially stabilized, have a particular level or polarity and/or other properties which are important for the correct functioning of switch components.

## Auxiliary voltage

→ *Auxiliary power supply*

## Dangerous failure

Failure with the potential to switch a safety-instrumented system to a hazardous or non-functioning safety state.

## EEPROM

EEPROM (Electrically Erasable Programmable Read-Only Memory): a non-volatile, electronic memory module.

EEPROMs are often used where individual bytes of data (e.g. configuration data or runtime meters) change over time and must be stored safely in the event of a mains power failure.

## Failure/Fault/Error

Failure:

A resource is no longer capable of executing a required function.

Fault/Error:

Undesired state of a resource indicated by its incapability of executing a required function.

## Fault/Error

→ *Failure/Fault/Error*

## Final controlling element

Converter that converts electrical signals into mechanical or other non-electric variables.

## Fingerprint

Numerical value generated by the device when you start safety validation via the "Functional Safety" wizard. By comparing the fingerprint, you determine whether or not the device and the safety-related parameters have changed erroneously during activation of the functional safety.

## Firmware

Firmware (FW) is software that is embedded on a chip in electronic devices – in contrast to software which is saved on hard disks, CD-ROMs or other media. These days, firmware is mostly stored in a flash memory or EEPROM.

Firmware usually contains the elementary functions for controlling the device, as well as input and output routines.

## Frequency shift keying

Frequency shift keying is a simple form of modulation, where the digital values 0 and 1 modulate the actual current signal by means of two different frequencies.

## Frequency Shift Keying (FSK)

→ *Frequency shift keying*

## HART

HART (Highway Addressable Remote Transducer) is a standardized, widely used communications system used to structure industrial fieldbusses. The communications system provides digital communications for multiple participants (field devices) via a common databus. HART is based especially on the equally widely used 4/20 mA standard for the transfer of analog sensor signals. The cabling from existing older systems can be used directly and both systems operated in parallel.

HART specifies several protocol levels in the OSI model. It facilitates the transfer of process and diagnostics data and control signals between field devices and high-level control systems. Standardized parameter sets can be used for the manufacture-independent operation of all HART devices.

Typical applications include transmitters for measuring mechanical and electrical dimensions.

## Measuring range adjustment

Ration of the minimum span to which a device can be set within the specified accuracy.

## Non-volatile memory

→ *EEPROM*

## r

→ *Measuring range adjustment*

**Risk**

Combination of the probability of damage occurring and the extent of the damage.

**Safety function**

Defined function executed by a safety-instrumented system with the objective of attaining or maintaining a safe system state by taking a defined hazardous incident into account.

Example:

Limit pressure monitoring

**Safety Integrity Level**

→ SIL

**Safety-instrumented system**

A safety-instrumented system (SIS) executes the safety functions that are required to achieve or maintain a safe state in a system. It consists of a sensor, logic unit/control system and final controlling element.

Example:

A safety-instrumented system is made up of a pressure transmitter, a limit signal sensor and a control valve.

**Sensor**

Converter that converts mechanical or other non-electric variables into electrical signals.

**SIL**

The international standard IEC 61508 defines four discrete safety integrity levels (SIL) from SIL 1 to SIL 4. Each level corresponds to a probability range for the failure of a safety function. The higher the SIL of the safety-instrumented system, the higher the probability that the required safety function will work.

The SIL which can be achieved is determined by the following safety-instrumented characteristics:

- Average probability of failure on demand ( $\text{PFD}_{\text{AVG}}$ )
- Hardware fault tolerance (HFT)
- Safe failure fraction (SFF)

**Total error**

Total Error is sum of Total Performance and the long-term stability.

**Total Error(s)**

→ *Total error*

**Total Performance**

Total Performance is the square root of the sum of the squares of the three deviations resulting from the influence of the static pressure, the temperature and the characteristic deviation.

**TP**

→ *Total Performance*



# Index

## 3

3A, 265

## A

ACCES

INVALID CFG, 209

Aluminum enclosure, 65

Ambient temperature, 242, 243, 244, 245

Effect, 225, 235

Application, 112, (Transfer function)

APPLICATION, 81

APPLY LRV, 81

APPLY URV, 81

Approval

3A, 265

EHEDG, 265

## B

Bidirectional flow measurement, 118

Blowout valve, 94

Blowout valves, 96

Bridge output voltage, 33, 38, 39

BUTTON LOCK, 81

## C

Cable gland

Installing, 63

Catalog

catalog sheets, 271

Certificates, 19, 271

CHANGE PIN, 81

Cleaning, 192

CONIC, 114

Current simulator trim, (See DAC trim)

CUSTM, 114

Customer Support, (Refer to Technical support)

CYLIN, 114

## D

DAC trim, 155

DAMPING, 81

Declaration of conformity for functional safety, (See SIL declaration of conformity)

DEVICE MODE, 81

Device plug

Installing, 63

Diagnostic messages, 202

Differential pressure, 26

Direct sunlight, 46

Disassembly, 66

DISPLAY TEST, 81

Disposal, 198

Document history, 16

Downloads, 271

## E

Edit view, 82

EHEDG, 265

Electromagnetic compatibility, 242, 244, 245, 246

EMC, 242, 244, 245, 246

ETEMP, 129

## F

FAULT CURR, 81

Filling liquid, 33, 37, 39

Fingerprint, 175

Flange, 52

FLAT, 114

FUNCT SAFETY, 81

Function chart, 35

Furnaces, 164

## H

HALF, 114

HART

Modem, 40

Hazardous area

Laws and directives, 19

Qualified personnel, 21

Hotline, (Refer to Support request)

HW exchange counter, 106

Hygienic version

Install, 51

## I

Identification data  
    define, 149  
IDENTIFY, 81  
In accordance with the square root function  
    see square-root extraction, 117  
Install  
    Remote seal, 56  
Insulation, 49  
internal overvoltage protection up to 6 kV, 253

## L

Laws and directives  
    Disassembly, 19  
    Personell, 19  
Layout of nameplate with general information, 28  
Level, 26  
LEVEL, 114, 129  
LEVEL UNITS, 81  
LO FAULT CUR, 81  
Load, 241  
LOOP TEST, 81  
LOOPT  
    INVALID CFG, 209  
LOW FLOW CUT, 81  
Low flow cut-off, 117, 134  
LOWER RANGE, 80  
LOWER SCALNG, 81

## M

Maintenance, 191  
Manuals, 271  
MAWP, 283  
Measurement point, 30  
Measurement view, 78  
Measuring cell  
    Absolute pressure, 35  
    Differential pressure and flow, 38  
    Gauge pressure, 33  
    Level, 39  
MFLOW, 129  
MFLOW UNITS, 81  
Modifications  
    correct usage, 20  
    improper, 20  
Mounting bracket  
    Install, 49

Mounting flange, 39  
MSL2B, 114  
MSLN, 114  
MSLN2, 114  
MSOFF, 114  
multi-channel operation, 165  
MWP, (See MAWP)

## N

Nameplate, 28

## O

Order supplement, 28  
OVERLD BEHAV, 81

## P

PARAB, 114  
PARAE, 114  
PARAM  
    INVALID CFG, 209  
Parameter  
    Parameter list, 103  
Parameter view, 80  
PIN RECOVERY, 81  
Position of the enclosure, 65  
PRESS, 114  
PRESS UNITS, 80  
PRESSURE REF, 81  
Pressure reference, 108  
Pressure units, 108  
Proof test, 182  
Proof Test Coverage, 183

## Q

QR code, 28  
Qualified personnel, 21  
Quick start, 103

## R

Recovery ID, 138  
RECOVERY ID, 81  
Remote seal  
    Install, 56  
    Maintenance, 192  
Remote seal measuring system, 56

RESET, 81  
Return procedure, 198

## S

Safety characteristic values, 167  
Safety function, 164  
Safety-related parameters, 169  
SATURAT HIGH, 81  
SATURAT LOW, 81  
Scope of delivery, 17  
Sealing plug  
    Technical specifications, 280  
Sealing plugs  
    Installing, 63  
Sensor calibration, 154  
Serial number, 29  
Service, 272  
Service and support  
    Internet, 272  
Shut-off valve, 95, 96, 98, 100  
SIL 2  
    Single-channel operation, 165  
SIL 3, 165  
SIL declaration of conformity, 167  
SIMUL  
    INVALID CFG, 209  
SPHER, 114  
SQRT POINT, 81  
Square root function  
    Hold at 0, square root, 117  
    Linear, square root, 117  
    Two step linear, square root, 118  
Stabilizing valve, 96, 97, 98, 100  
Stainless steel enclosure, 66  
START VIEW, 81  
Structure, 27  
STSIM  
    INVALID CFG, 209  
Support, 272  
Support request, 272  
SV SELECT, 81

## T

Tank connection, 269  
Technical support, 272  
    partner, 272  
    personal contact, 272  
TEMP, 129  
TEMP UNITS, 81

Test certificates, 19  
Threaded adapter  
    Technical specifications, 280  
Torque, 280  
Torques, 252  
Transfer function, (See Application)  
TRNFK  
    INVALID CFG, 209  
Turndown, 283

## U

UP FAULT CUR, 81  
UPPER RANGE, 80  
UPPER SCALNG, 81  
Useful lifetime, 167  
USER, 129  
User PIN, 140  
    Factory setting, 137  
USER PIN, 81

## V

Vent valve, 98, 100  
VESSEL DIM A, 81  
VESSEL DIM L, 81  
VFLOW, 129  
VFLOW UNITS, 81  
VLIN, 114  
VOL, 129  
VOL UNITS, 81  
VSL2B, 114  
VSLN, 114  
VSLN2, 114  
VSOFF, 114

## W

Warranty, 18  
Write protection, 84  
    Jumper, 84

## Z

ZERO POINT, 81

