

Operating Manual



METS-IR - Temperature Sensor -HART- 1 Channel

METS-IR

● Content

1	General (Information, Signs and Abbreviations)	3
2	Transport, Packaging, Storage	3
3	For Your Safety	4
4	Start-Up, Operation	5
4.1	Function	5
4.2	Before Mounting	5
4.3	Product Label	5
4.4	Mounting	5
4.5	Electrical Operation	7
4.6	Electrical Connection	8
4.7	Connecting the Switching Outputs	9
4.8	Functional Check	10
5	Fault Recognition / Fault Current	10
6	Handling and Configuration	11
6.1	Basics of System Operation	11
6.2	Main Menu	14
6.3	Base Menu	14
6.4	Display Menu	17
6.5	Switch Point Menu	18
6.6	Calibration Menu	20
6.7	System Menu	21
6.8	Overview	23
7	Troubleshooting	24
8	Maintenance, Dismounting, Return, Cleaning, Disposal	25
9	Technical Data	26
10	Optical Diagrams and Emissivity	28
11	Dimensions	31
12	HART-Communication	32
13	Accessories	32

● 1 General

1.1 For Your Information

- These operation instructions contain important information on handling the infrared temperature sensor. Working safely requires that all safety instructions and work instructions are observed.
- Skilled personnel must have carefully read and understood the operating instructions prior to beginning any work.
- The operating instructions are part of the product and must be kept in the immediate vicinity of the METS-IR and readily accessible to skilled personnel at any time.
- Observe the relevant local accident prevention regulations and general safety regulations for the sensor's range of use.
- If the serial number gets illegible (e. g. by mechanical damage), retraceability of the device becomes impossible.
- The screw-in infrared temperature sensors METS-IR described in this operating manual are carefully designed and manufactured using state-of-the-art technology. Every component undergoes strict quality inspection in all stages of manufacture.
- The manufacturer's liability is void in the case of any damage caused by using the product contrary to its intended use, non-compliance with these operating instructions, unauthorised modifications to the METS-IR or assignment of insufficiently qualified skilled personnel.

1.2 Signs and Abbreviations



Warning!

Non-compliance can cause injuries to persons and/or the demolition of the device. There can be a danger to life.



Attention!

Non-compliance can cause faulty device operation or lead to property damage.



Information!

Non-compliance can have influence on device operation or cause unintentional device reactions.



Danger!

Non-compliance with the safety instructions represents a risk of serious or fatal injuries caused by electrical power.



Warning!

Possible dangerous situations caused by hot surfaces or liquids, which can lead to burns. Please avoid hot surfaces and liquids.

● 2 Transport, Packaging, Storage

2.1 Transport

Check the device for any damage that may have been caused during transportation. Report obvious damage at once.

2.2 Packaging

Do not remove packaging until just before mounting. Keep the packaging as it will provide optimum protection during transport (e. g. change in installation site, return).

2.3 Storage

For longer term storage avoid the following influences:

- Direct sunlight or proximity to hot objects
- Mechanical vibration, mechanical shock (rough deployment)
- Soot, vapour, dust and corrosive gases

If possible store the device in its original package or an equivalent one.

● 3 For Your Safety



Before installation, commissioning and operation select the appropriate infrared temperature sensor in terms of function and equipment.



More important safety instructions can be found in the individual chapters.

3.1 Intended Use of the Product

The device has been designed and built solely for the intended use described here and may only be used accordingly.

The technical specifications contained in these operating instructions must be observed. Improper handling or operation of the device outside of its technical specifications requires the device to be taken out of service immediately and an inspection by the manufacturer.

When the device is transported from a cold into a warm environment, the formation of condensation may cause the device to malfunction. Before putting it back into operation, wait for the device temperature and the room temperature to equalise.

The manufacturer shall not be liable for claims of any type based on operation contrary to the intended use.

3.2 Personnel Qualification



Risk of injury if qualification is insufficient

Improper handling can result in considerable injury and damage to equipment.

- The activities described in these operating instructions may only be carried out by skilled personnel who have the qualifications described below.
- Keep unqualified personnel away from hazardous areas.

For installation and start-up of the METS-IR the personnel has to be familiar with the relevant regulations and directives of the country and must have the required qualification. They must have knowledge on measurement and control technology, have to be acquainted with electric circuits, are capable of carrying out the work described and can independently recognise potential hazards. Depending on the operational conditions they need to have the corresponding knowledge, e.g. of aggressive media.

3.3 Special Hazards



In addition to all standard regulations, the appropriate existing codes or regulations must also be followed.

If you do not observe the appropriate regulation, serious injuries and/or damage can occur!



A protection from electrostatic discharge (ESD) is required.

The proper use of grounded work surfaces and personal wrist straps is required when working with exposed circuitry (PCB, printed circuit boards), in order to prevent static discharge from damaging sensitive electronic components.



There is a danger of death caused by electric current.

Upon contact with live parts, there is a direct danger of death.

Electrical instruments may only be installed and connected by skilled electrical personnel.

Operation using a defective power supply unit (e.g. short circuit from the mains voltage to the voltage output) can result in life-threatening voltages at the device.



Do not use this instrument in safety or emergency stop devices. Incorrect use of the device can result in injury.

● 4 Start-Up, Operation

4.1 Function

The screw-in infrared temperature sensor METS-IR HART is a sensor designed for process control with non-contact temperature measuring. The device receives infrared radiation emitted from a test object and, based on this foundation, calculates the surface temperature of the test object.

- The intensity of the infrared radiation emitted by a test object is dependent on the temperature **and the emissivity** of the test object. The sensor should be set to the right emissivity to avoid biased measurement results.

4.2 Before Mounting

- - Check if the METS-IR was delivered in complete assembly.
 - Inspect the sensor for possible damage during transportation. Should there be any obvious damage, inform the transport company and supplier immediately.
 - Keep the packaging, as it offers optimal protection during transportation.
 - Make sure to protect the connecting contacts from damage.

4.3 Product Label (Example)

Logo	Art.Nr.: 1500-00083	CE	
	SN.: 128.01/14-10.0-001	Made in Germany	
Range	: -40 ... 1000 °C	Supply : 24 VDC (1+ / 8-)	Date :
Contact	: 2 x PNP 30V/200mA	Output : 4 ... 20 mA (3)	14 / 14

Art.Nr.: Part number

SN : Serial number

4.4 Mounting

- ! METS-IR sensors are sensitive optical systems. The mounting should only be carried out over the existing screw thread. Please avoid brute force at the measurement head. Brute force can lead to the destruction of the device.

- - Check the delivery immediately for completeness and obvious faults.
 - If parts are missing or if there are faults, contact the transport company and supplier immediately.

● 4 Start-Up, Operation (Continued)

4.4 Mounting (Continued)

Condensation can, i. a. by fogging the sensor-lens, create failure malfunctions like biased measurement results.

- Avoid operation in condensation-generating atmosphere!

Example METS-IR in Sideview

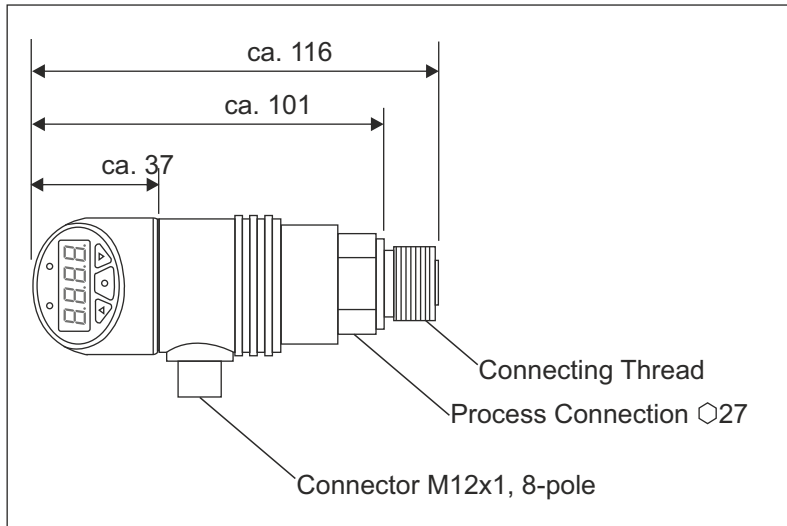

4.4.2 Mounting Process Connection

Tools: Wrench SW27, Screw driver

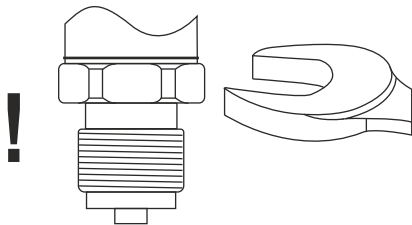

Please make sure at mounting to have clean and undamaged sealing surfaces at sensor and point of measurement.

Only screw the sensor in and out over the spanner flat with a suitable tool and the required torque. The required torque is dependent on the dimensions of the process connection.

Don't use the casing of the device as contact surface.

Make sure to not tilt the threads at at screw-in.

Please comply with specifications for female threads and welding sockets!

4.4.3 Setting of Display Unit

The display unit can be rotated by ca. 300° for better reading. To turn the unit, hold down the plastic body with one hand and turn the display unit into the desired position using the other hand.

The turning angle is restricted by a stopper inside the device. Do not overwind past the stopper. This could destroy the device.

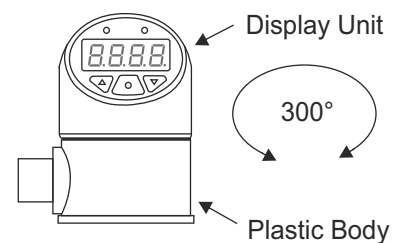

● 4 Start-Up, Operation (Continued)

4.5 Electrical Operation



Connect the 8-pole M12x1-connector to the electrical connection of the sensor. The supply voltage needs to be the same as specified on the product label.

Only operate the device when mounted.

Follow the indicated temperature restrictions for the use of the device before and during operation.

Additionally, please observe the connection plug arrangement, see chapter 5 for an illustration.



Danger

Danger by electrical shock! Conduct electrical installation only in dead voltage condition.



Property damage by electrostatic discharge!

Follow safety precautions corresponding to DIN EN 61340-51/-3 to prevent an electrostatic charge!



Only qualified personnel are allowed to conduct work on the electronic circuits.

● 4 Start-Up, Operation (Continued)

4.6 Electrical Connection

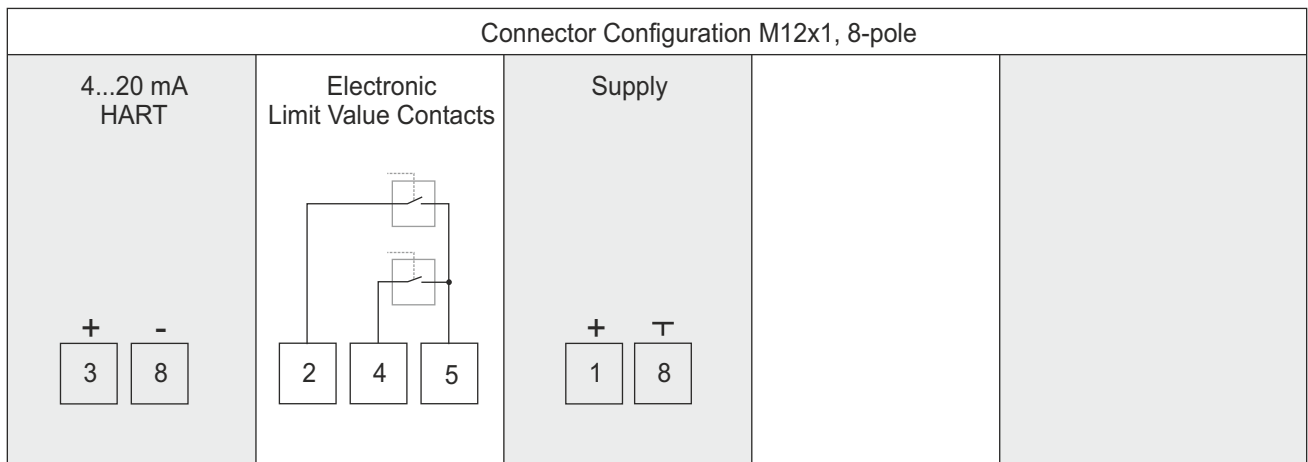

Electrical Connection Example

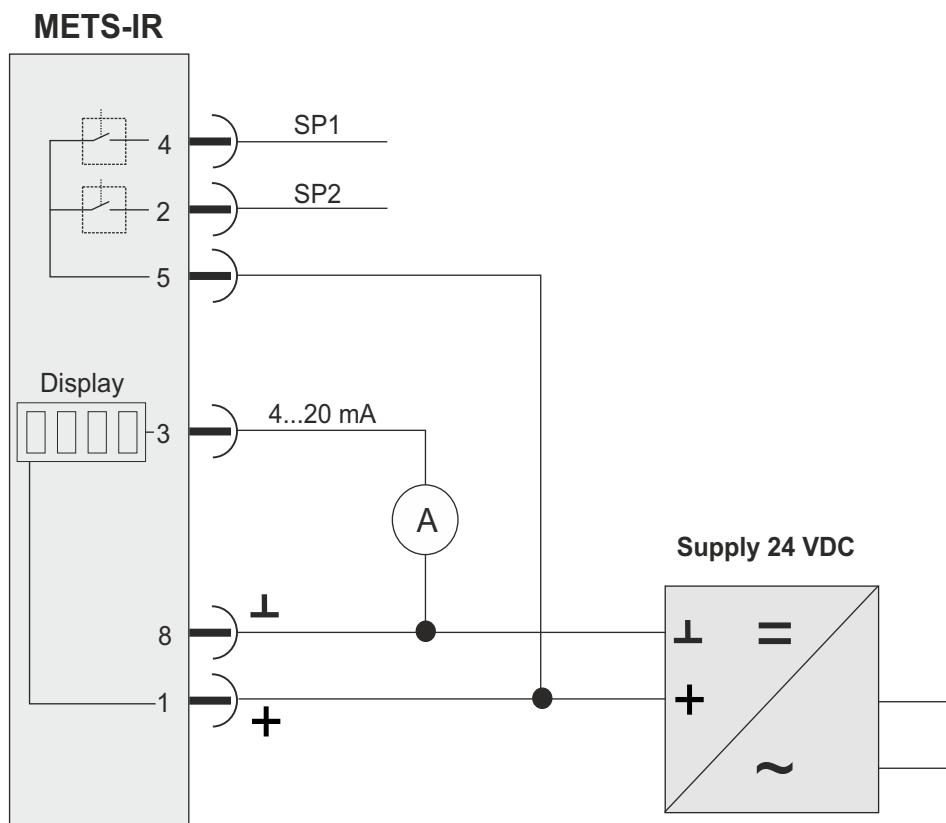

1. Take the value for the supply voltage from the product label or from the diagrams above.
2. Connect conductors as shown in the relevant diagram.
3. The sensor starts immediately when supply voltage is applied.

● 4 Start-Up, Operation (Continued)

4.7 Connecting the Switching Outputs

The switching outputs are potential-free. They are electrically isolated from the current loop (see right).

In case of using only one switching point it is possible to connect the load on both sides of the contact, e.g. NPN-style: load connected to high or low side (see below).

Use an appropriate recovery diode if you want to switch inductive loads.

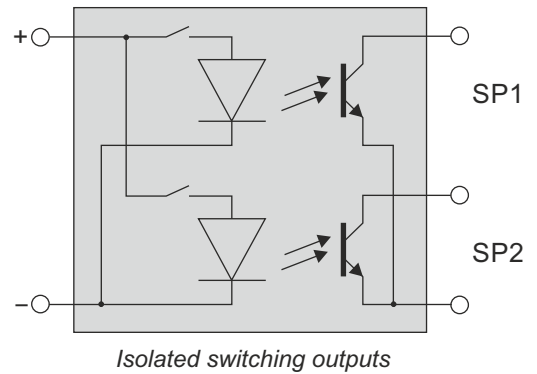

Switching outputs with common on low side (NPN)		
Two outputs are used	One output is used, load on high side	One output is used, load on low side

Switching outputs with common on high side (PNP)		
Two outputs are used	One output is used, load on high side	One output is used, load on low side

● 4 Start-Up, Operation (Continued)

4.8 Functional Check

- The output-signal has to be proportional to the temperature. If it isn't, it can be a sign of a wrong mounting-position or a wrong configuration setting. Please read further under *Troubleshooting* (page 24) in this case.

● 5 Fault Recognition / Fault Current

Fault Recognition / Fault Current

When using the maximum measuring range (LRL...URL) the output current is limited to 4...20 mA. The devices with 4-wire systems can use fault recognition only when the used measuring range is smaller than the maximum measuring range. Example: Maximum measuring range: -40...1000 °C (LRL...URL), used measuring range (turndown): 0...800 °C (LRV...URV). The device then detects wire breaks and short circuits (sensor element <> measuring amplifier) as well as temperatures outside of the measuring range and indicates this with a fault current in the current loop circuit.

With this, the current output is then proportional to the load from 3,8 to 20,5 mA. If the measured temperature would result in a current below 3,8 mA the current output is set to 3,6 mA. If the current would exceed 20,5 mA, the current output is set to 21 mA (also for wire break and wire short circuit).

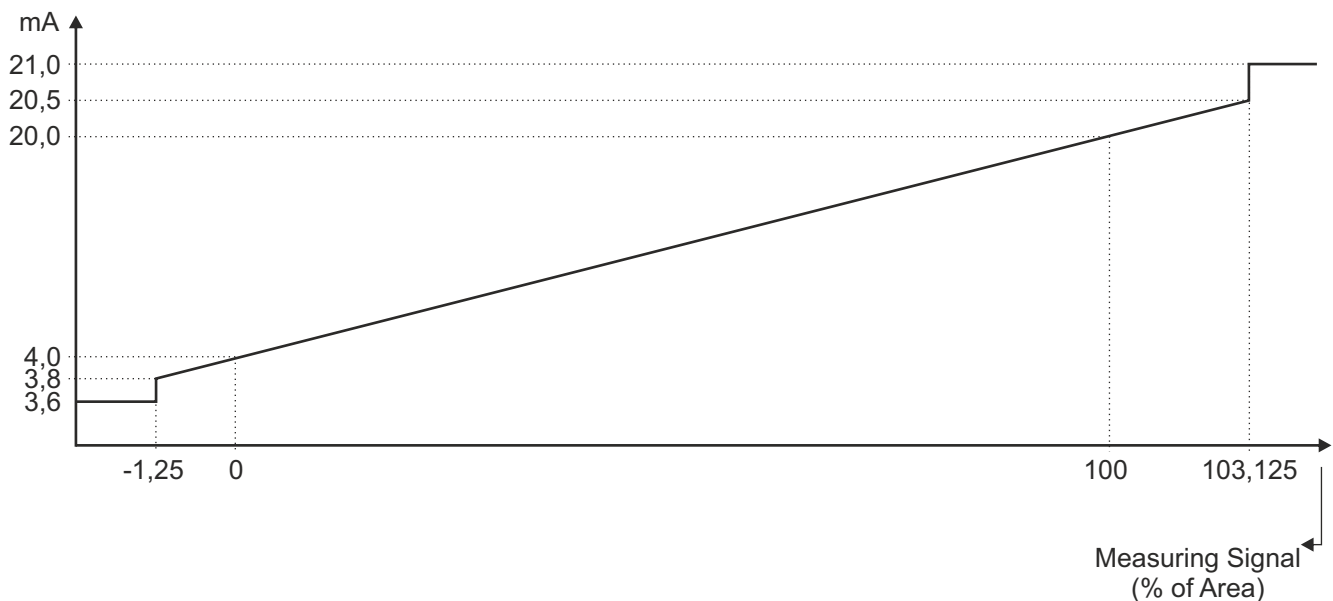

Current Output and Measuring Signal

● 6 Handling and Configuration

Description of handling and configuration of the display device.

An overview of the menu tree is shown on page 23.





The 3 buttons on the display head operate by capacitive principle with no mechanical components: When pressing a button, there is no key drop. The buttons are reacting to the approach of a finger via sensing its electromagnetic field. Withdraw your finger at least 1 cm after pressing a button. This is useful for proper keypress detection.

The following description is for a device configuration using capacitive buttons. The configuration via HART communication modem is described in a separate manual.

6.1 Basics of System Operation

6.1.1 Key Recognition System Feedback

The LEDs for switching output are used to give operator feedback when buttons are pressed. This does not affect the switching outputs themselves. When no button is pressed the LEDs are showing the state of the switching outputs.

Button		Feedback
	Arrow button down (left)	Left LED is flashing
	Arrow button up (right)	Right LED is flashing
	Both arrow buttons simultaneously	Both LEDs are flashing
	Center button	Both LEDs are flashing rapidly

Button feedback

6.1.2 Display Mode / Measured Value Indication

After power up the device starts in display mode. The current measured value is displayed or is displayed alternately with the unit (see 6.4.1).

The displayed value is flashing when the measured value is greater than the maximal presentable value. This can be caused by a fixed decimal point (see 6.4.3).

As long as the center button is pressed the selected unit will be displayed.

A single arrow button has no function in display mode.

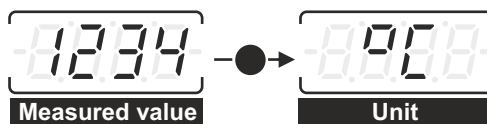

Unit indication

6.1.3 Activating the Configuration Mode

After pressing both arrow keys simultaneously and holding them for at least 2 s, the device enters configuration mode. The first entry of the operator menu appears on the display (bA5E). If both buttons are not released within 4 s, the device switches back to display mode, showing the current measured value again.

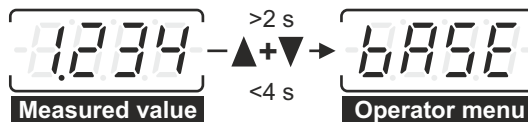

Activating the configuration mode

6 Handling and Configuration (Continued)

6.1.4 Configuration Mode / Operator Menu

The configuration mode always starts with the first item of the main menu (bASE). Within the menu you navigate with the arrow buttons. The center button selects a menu item respectively enters a submenu. Menu items which just show a value (e.g. maximum pointer) can be exit to the next upper menu item with the center button.

Every menu has the item „rEt-“ (return) which allows you to go back to the next upper menu. In the main menu it goes back to the display mode.

At the end of a menu (typically „rEt-“) you return to the first menu item when pressing the down arrow button again. Similiary, you jump to the end of the menu when pressing the up arrow in the first menu item.

In each menu item it is possible to return to the next upper menu by pressing both arrow buttons simultaneously. The feedback is a flashing „rEt-“. When holding the buttuns for longer than 1 s, the device returns to display mode, giving a flashing „ESc-“ (escape) as feedback.

If no button is pressed for 5 minutes in configuration mode, the device automatically switches back to the display mode.

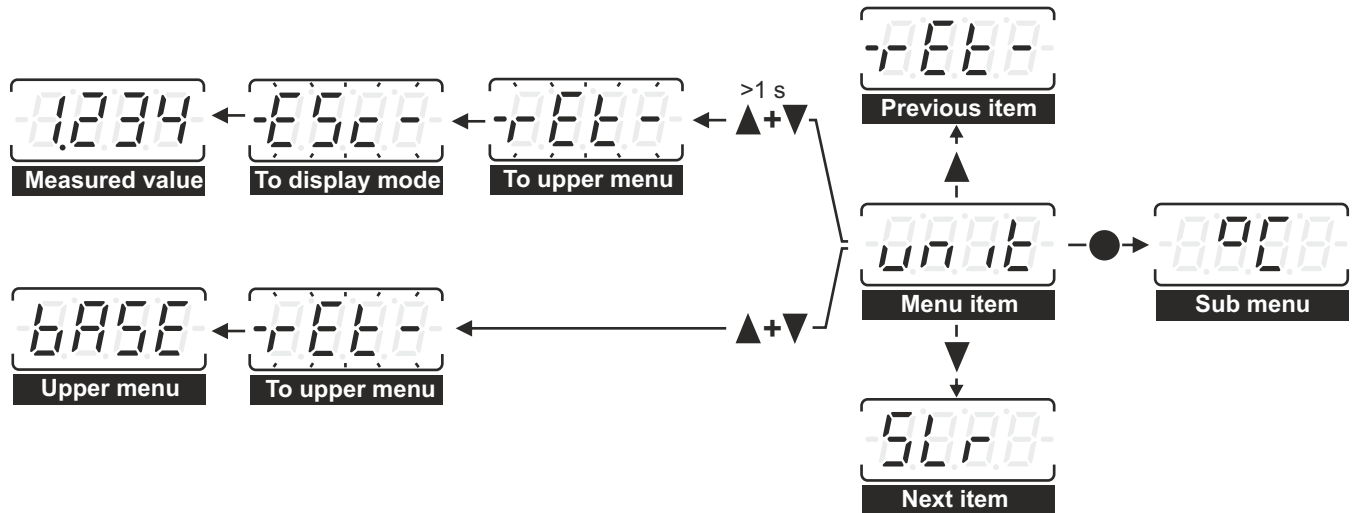

Configuration mode: Example operator menu

6.1.5 Setting Values

There are 2 types of values that can be altered:

- values which can be selected from a predefined parameter list
- numerical values

Selecting a value from a list

Parameter lists are used, e. g. for units. Within the list you navigate with the arrow buttons. With the center button a selected value is stored and confirmed by indicating „Stor“. After that the device is in the next upper menu.

The list can be left by pressing both arrow buttons simultaneously. This jumps back to the next upper menu without changing the present value.

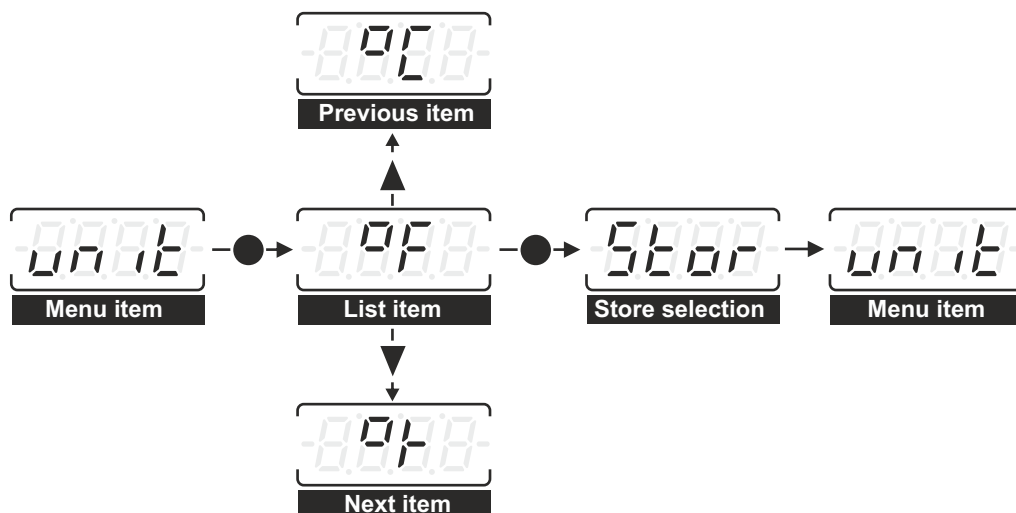

Configuration mode: Example to select a value from a list

● 6 Handling and Configuration (Continued)

Setting a numerical value

Numerical values are entered digit by digit. The selected digit flashes and is incremented with the up arrow button and decremented with the down arrow button. The more significant digit will also be incremented or decremented when stepping over zero. If a change of the active digit would exceed the allowable value (e. g. the lower or upper range limit) the allowable value will be shown. With the opposite arrow button you can return to the previous value.

The selected digit is confirmed with the center button and proceed to the next digit. You can cancel the value entry at any time by pressing both arrow buttons simultaneously. The device will then switch back to the corresponding menu entry. The partially edited value will not be saved.

When the right-most digit is selected, the center button confirms the whole value. "Stor" appears on the display to confirm that the value has been stored and the device switches back to the menu item for the value.

You can store a partially edited value at any digit position by holding the center button until "Stor" appears on the display (approx. 2 s).

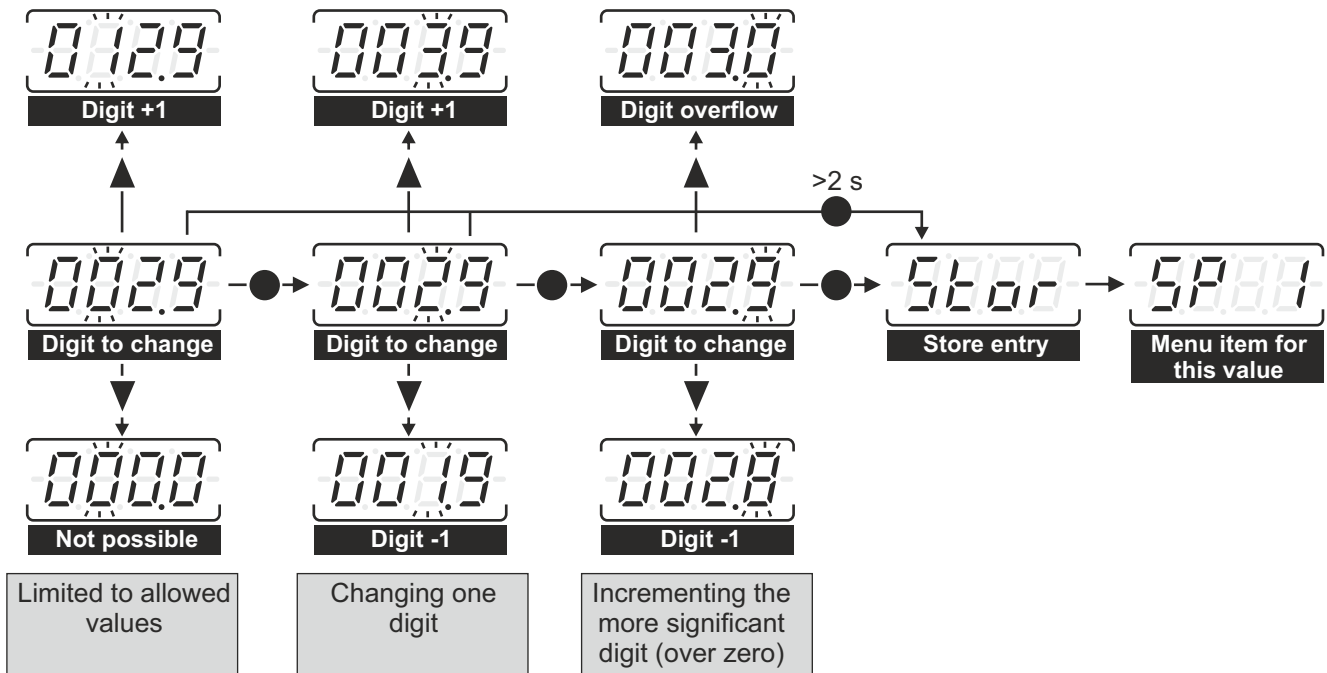







Button functions for entering numerical values (Example)

● 6 Handling and Configuration (Continued)







6.2 Main Menu

The main menu has the following functions

Display	Designation	Description
	Basic functions	Setting of unit, lower and upper range value, show/delete minimum and maximum pointer
	Display functions	All settings related to the display
	Switch point settings	Configuration of the switching outputs (option)
	Calibration functions	Teaching lower and upper ranges, calibrating the current output
	System data	Reset to factory settings, loop test, Displaying of: hardware version, software version, serial number
	Return	Return to display mode

6.3 Base Menu (bASE)

The base menu has the following functions

Display	Designation	Description
	Measuring unit	Setting the measuring unit (parameter list)
	Set lower range	Setting the temperature corresponding to 4 mA current signal
	Set upper range	Setting the temperature corresponding to 20 mA current signal
	Set damping	Setting the damping for the measuring signal
	Trailing pointer minimum (low)	Display and/or delete the minimum trailing pointer
	Trailing pointer maximum (high)	Display and/or delete the maximum trailing pointer
	Return	Return to main menu

6 Handling and Configuration (Continued)

6.3.1 Setting the Measuring Unit (unit)

A selected unit applies to data entries (e.g. switching points) and to the display of numerical values (e.g. the trailing pointers). Possible are the following units:

Display	Unit	Display	Unit
	°C (Celsius)		°F (Fahrenheit)
	K (Kelvin)		% (Percent of measurement range)
	mA		Return to Base Menu

Example for the steps needed to change the unit from Celsius to Fahrenheit:

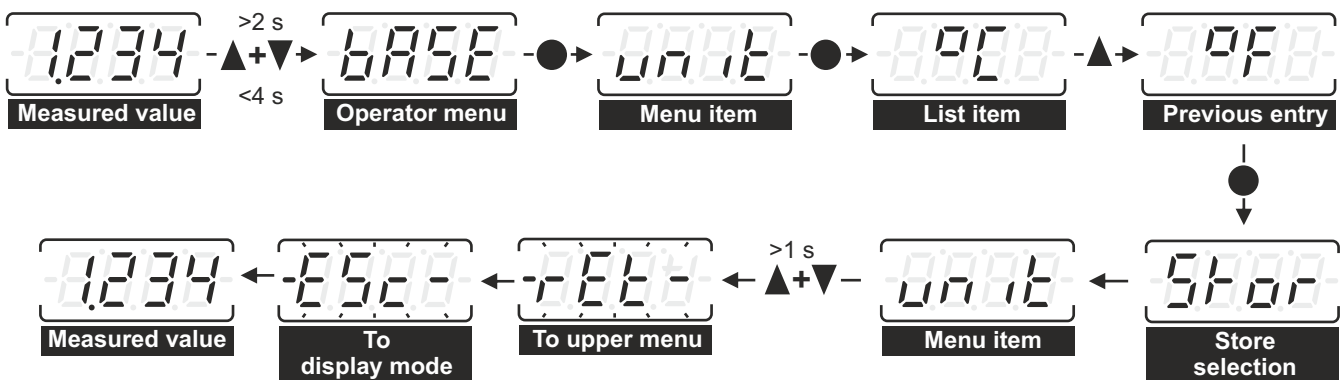

Steps to change the unit

6.3.2 Setting Lower and Upper Ranges (SLr / Sur)

It is possible to set the lower range (SLr) and the upper range (Sur) value as needed within the allowed measurement range of the device (lower and upper range limit), which is also known as „turn down“. The minimum span is about 10% of the maximum range (see technical data). Make sure that there are no settings outside the permitted measurement range.

Select the desired menu item and then enter the measurement value which has to correspond to 4 mA (SLr) or 20 mA (Sur) loop current. This will not affect the calibration of the transmitter and the current output.

A change of the measuring range will delete the trailing pointers automatically.

This function is not available with the units %, mA.

Note: Although the switch points are set in the chosen unit, they are saved as a percentage of the range. Therefore the absolute switch point load will change with every new setting of the range. So it is always necessary to check the settings of the switch points after new range values have been set.

● 6 Handling and Configuration (Continued)

6.3.3 Setting the Damping (dAP)

The damping of the measurement signal can be set in intervals of 0.1 s. Damping is disabled when set to 0.0 s. The default setting is 0 s.

6.3.4 Trailing Pointers (Lo/Hi)

The trailing pointers for minimum and maximum values can be displayed or reset. A reset is confirmed with „----“ on the display.

The trailing pointer shows „Er.Lo“ respectively „Er.Hi“ if the current output has been set to an error current (see chapter 5).

Display	Designation	Description
	Value of the min/max pointer	Value of the min/max pointer in the selected measuring unit
	Clear	Reset the stored pointer value
	Return	Return to „Lo“ or „Hi“

The steps to reset the minimum pointer are shown below.

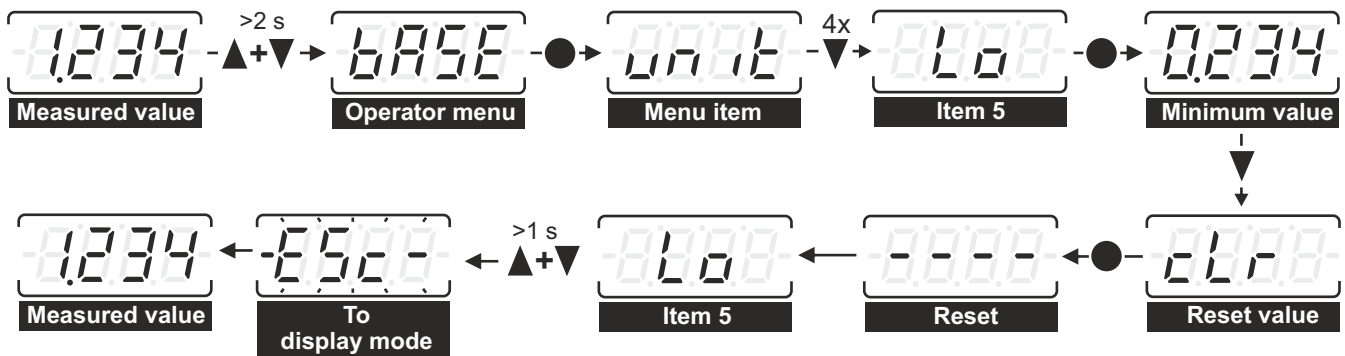

Steps to reset the minimum pointer

● 6 Handling and Configuration (Continued)

6.4 Display Menu (diSP)

The display menu has the following functions. The options „td“ and „tu“ are only displayed if „AddU“ is set to „off“.

Display	Designation	Description
	Add unit	Remove or add unit to the display
	Display period for measured value (time data)	Setting between 0,5...99,9 s possible
	Display period for unit (time unit)	Setting between 0,5...99,9 s possible
	Rotate 180°	Rotate screen by 180° when the device is mounted upside down
	Decimal places	Setting the decimal places (0...3 fixed decimal places or automatic)
	Return	Return to „diSP“

6.4.1 Add Unit (AddU)

The display of the set unit in the display can be toggled. If the unit isn't shown in the display, pressing the middle menu button will toggle the display on. Otherwise the display will switch automatically between showing the measured value and showing the unit. In this case the display time is dependent on the setting under “td” and “tu”.

Display	Designation	Description
	Display unit	The set unit will be added to the display on the right of the measured values.
	Do not display unit	The set unit won't be displayed.
	Return	Return to „AddU“

6.4.2 Rotating the Display by 180° (rot)







In case of mounting the device upside down, the 7-segment display and buttons can be rotated by 180° so that reading and operating are possible as usual.

Display	Designation	Description
	Standard (0°)	Resets display back to normal. Has no function otherwise.
	Upside down (180°)	Display rotated by 180° for upside down operation
	Return	Return to „rot“

● 6 Handling and Configuration (Continued)

6.4.3 Decimal Point Setting(dEcP)









Possible is a fixed or an automatic positioning of the decimal point.

Display	Designation	Description
	Automatic	The decimal point is set so that all digits are fully used
	No decimal place	
	One decimal place	
	Two decimal places	
	Three decimal places	
	Return	Return to „dEcP“

Please note that when the decimal point is fixed the measured value may not be displayed if there are insufficient digits left of the decimal point. In this case the maximum number that can be shown on the display will appear flashing, e.g. "99.99", when two decimal places are set for a measured value of 110.

6.5 Switch Point Menu (SP)

The menu has items for the settings of the two switch points. The output behaviour can be a hysteresis or a frame function where the menu items are different. The switching delays can be defined independently from the output function.

Display	Designation	Description
	Switch point	Switchpoint in the selected measuring unit
	Reset point	Reset point in the selected unit
	Delay switch	Output delay at switch point
	Delay reset	Output delay at reset point
	Output function	Configuring the output behaviour (normally open, normally close, hysteresis / frame function)
	LED switch point	Behaviour-settings for the switchpoint-LED
Menu items for switch point 2		
	Return (return)	Return to „SP“
Menu items for LED 1 and LED 2, respectively		
	Electrical behaviour	The LED glows if the switchpoint contact is closed.
	Logical behaviour	The LED glows if the switchpoint value is reached or if it falls into the frame.

● 6 Handling and Configuration (Continued)

The switch point (SP) must be between the upper range value (URV) and the reset point. The reset point (rP) must be between the lower range value (LRV) and the switch point. The minimum hysteresis (difference between switch point and reset point) is 0,5% of the measuring range (MR) which is configured under 6.3.2.

It is possible to define a delay for the switch point as well as the reset point, e. g. to avoid short error signals triggering the switch.

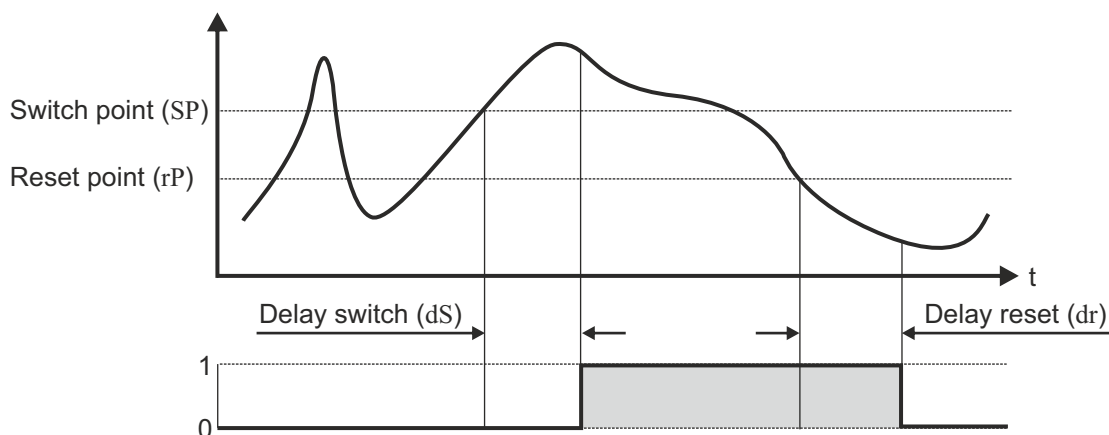
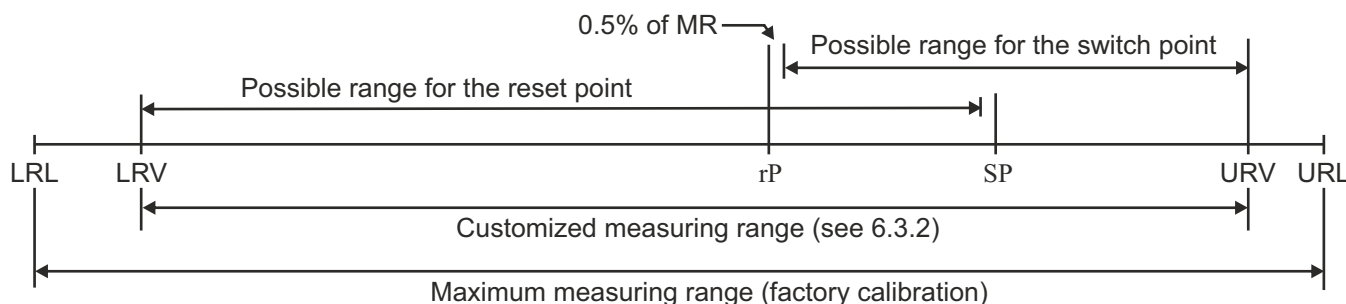





When the frame function is used, the menu items for switch point and reset point are replaced by the upper and lower frame limits. The minimum difference of the frame limits is 0,5% of the measuring range (MR) which is configured under 6.3.2.

Display	Designation	Description
	Frame high	Upper frame limit in the selected measuring unit
	Frame low	Lower frame limit in the selected measuring unit
	Delay switch	Output delay when entering the frame
	Delay reset	Output delay when leaving the frame
	Output function	Configuring the output behaviour (normally open, normally close, hysteresis / frame function)
	LED switch point	Behaviour-settings for the switchpoint-LED
Menu items for switch point 2		
	Return	Return to „SP“

● 6 Handling and Configuration (Continued)

6.5.1 Configuring the Output Function (out 1 / 2)



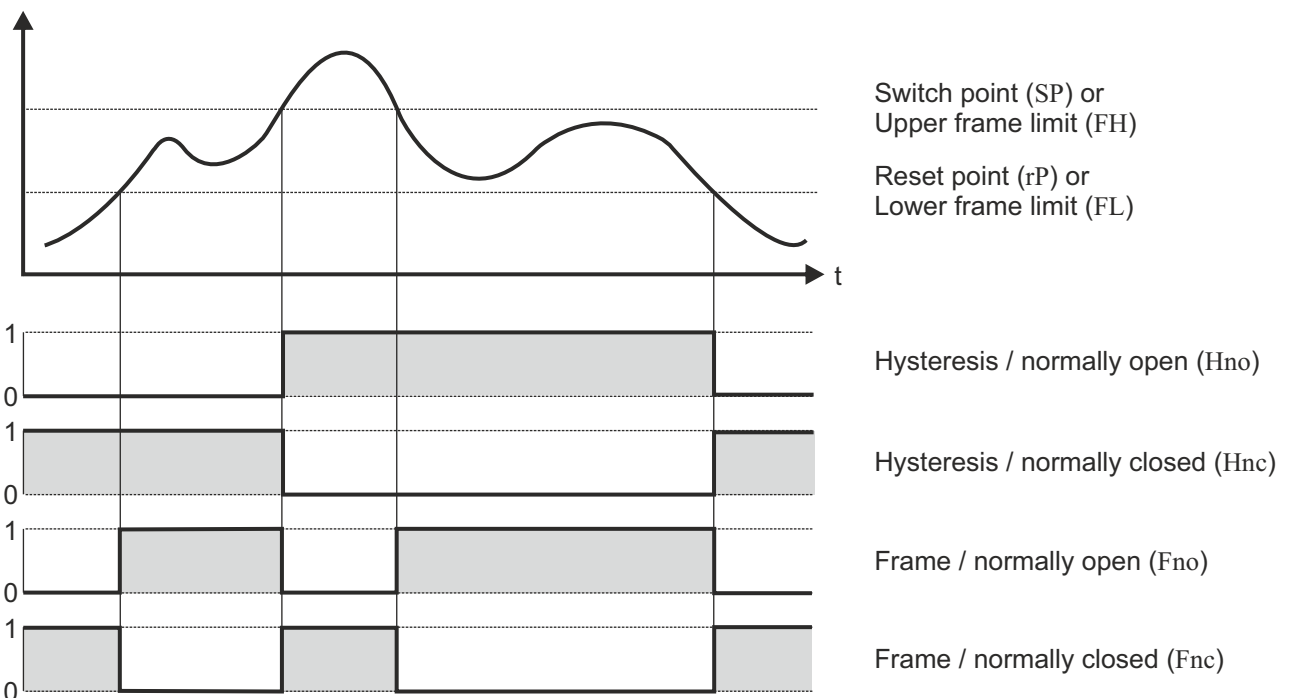

Possible are hysteresis or frame functions and the output as normally open or closed contacts .

Display	Designation	Description
	Hysteresis, normally open	If the input-signal is above the switch point the switch is closed. At the lower range limit the switch is open.
	Hysteresis, normally closed	If the input-signal is above the switch point the switch is open. At the lower range limit the switch is closed.
	Frame, normally open	Inside of the frame the switch is closed. At the lower range limit the switch is open.
	Frame, normally closed	Inside of the frame the switch is open. At the lower range limit the switch is closed.
	Return	Return to „out 1" or „out 2"



6.6 Calibration Menu (CAL)

The calibration menu has the following functions

Display	Designation	Description
	Teach lower range	Adjust the lower range (4 mA) to the applied input-signal
	Teach upper range	Adjust the upper range (20 mA) to the applied input-signal
	Adjust 4 mA	Adjust the current output at 4 mA
	Adjust 20 mA	Adjust the current output at 20 mA
	Return	Return to „CAL"

● 6 Handling and Configuration (Continued)



6.6.1 Adjusting Lower and Upper Range (tLr/ tur)

It is possible to adjust the output current for the lower range value (LRV) and the upper range value (URV) under the menu items „tLr“ and „tur“ to a certain input-signal.

For the adjustment a stable input-signal according the settings in chapter 6.3.2 has to be applied, e. g. by using a adjuster. Then enter the calibration menu and select „tLr“ respectively „tur“. When entering the menu, the entry points to „rEt“. To confirm the applied input-signal, go to „YES“ with one of the arrow buttons and press the center button. After this final confirmation the applied input-signal will be matched to the lower or upper range value.

Example: Set the the lower range value to 300 K, like it was shown in chapter 6.3.2 . For the modification the sensor is irradiated with infrared until the device measures a temperature of 300 K. When the display reading is stable, go to the menu item „Teach Lower Range“ and confirm with „YES“. From now on the transmitter will regard the actual sensor element reading as 300 K. The internal calculation of the temperature will be adapted accordingly.

When confirming with the center button „donE“ appears on the display which confirms that the device has acknowledged the change. Then the device switches back to the initial menu item („tLr“ or „tur“).

Display	Designation	Description
	Return	Return to „tLr“ or „tur“
	Yes	Adjust the lower or upper range value to the applied input-signal

6.6.2 Adjusting the Current Output (4 mA/20 mA)

It is possible to adjust the output current to eliminate tolerances and systemical deviations in the output driver or subsequent devices in the current loop.

Below are the steps for the lower current limit (4 mA). The adjusting of the upper current limit (20 mA) is done similar.





Select the menu item „4 mA“ and the device sets the output current to 4 mA. The display shows „04.00“. Now check the reading on the remote measuring instrument. If it deviates from 4 mA, enter this value in the device.

Example: The remote instrument shows 4.02 mA due to tolerances in the current loop. Enter then „04.02“ at the device.

If the value is confirmed the device will adjust the current output so that the remote instrument now will show 4.00 mA. The device will hold the 4 mA current output for 3 seconds so that it's possible to check the reading of the remote instrument. During this time the display will show „Stor“. After that period the device will calculate the current output depending on the sensor signal (load) and switch back to the menu item „4 mA“.

6.7 System Menu (SYS)

The system menu has the following functions

Display	Designation	Description
	Loop test	Setting a fixed current in order to test the current loop
	Information	Indicating of hardware and software version, serial number
	Reset	Reset to factory settings
	Return	Return to „SYS“

● 6 Handling and Configuration (Continued)







6.7.1 Loop Test (LoOP)

The device can be used to test the current loop. For this the current output can be set to any value between 3.6...21 mA. When an entry is confirmed, the transmitter sets the output current to the selected value and displays this value flashing. The flashing shows that the displayed value is not a valid measurement.

Note: In this mode the device will not return to the display mode after 5 minutes but continue the test until the operator will stop it by pressing the center button or both arrow buttons. The device returns to the menu item „LoOP“ and the output current returns to the value which is corresponding to the measured sensor signal.

6.7.2 Information (inFo)

The information menu has the following functions



Display	Designation	Display	Designation
	Hardware version 1 (HW1)		Software version 2 (SW2)
	Hardware version 2 (HW2)		Serial number 1 (Sn 1)
	Software version 1 (SW1)		Serial number 2 (Sn 2)
	Return	Return to „InFo“	

Due to the limited number of alphanumerical segments on the display the values for these items are splitted.

6.7.3 Reset to Factory Settings (rES)

It is possible to reset the device to the configuration as delivered with the menu item „Reset“ (rES). When entering the menu the entry points to „rEt“. To confirm the reset go to „YES“ with one of the arrow buttons and press the center button. After this final confirmation all parameters will be changed to the settings as delivered.

When confirming with the center button „donE“ appears on the display which confirms that the device has been reset to factory settings. Then the device switches back to the initial menu item („rES“).

Display	Designation	Description
	Return	Return to „rES“
	Yes	Resetting the device to factory settings

6 Handling and Configuration (Continued)

6.8 Menu Tree Overview

BASE		Menu with basic functions
	unit	Setting the measuring unit (see table under 6.3.1)
	SLr	Setting the sensor signal (LRV) which corresponds to 4 mA output signal (all units except % and mA)
	SUR	Setting the sensor signal (URV) which corresponds to 20 mA output signal (all units except % and mA)
	dAMP	Setting the damping for the distance signal
	Lo	Display and/or delete the minimum trailing pointer
	Hi	Display and/or delete the maximum trailing pointer
DISP		All settings relating to the display
	AddU	Add and remove unit to display
	td	Setting the display period for the measured value (Only visible if AddU = off)
	tu	Setting the display period for the unit (Only visible if AddU = off)
	rot	Display direction (0° = standard, 180° = turned)
	decP	Display the decimal places (0...3 fixed decimal places or automatically)
SP		Configuring the switching outputs (when available)
	SP 1 FH 1	Switch point or upper frame limit of switching output 1
	rP 1 FL 1	Reset point or lower frame limit of switching output 1
	ds 1	Output delay at the switch point of switching output 1
	dr 1	Output delay at the reset point of switching output 1
	out 1	Output functions of switching output 1 (Hno, Hnc, Fno, Fnc)
	LEd 1	Switchpoint-LED behaviour (ELEc, Logi)
		Menu items for switch point 2
CAL		Calibration menu
	ELr	Adjusting the lower range value (4 mA) to the applied sensor signal
	EUR	Adjusting the upper range value (20 mA) to the applied sensor signal
	4nA	Adjusting the current output at 4 mA
	20nA	Adjusting the current output at 20 mA
SYS		System functions
	Loop	Setting a fixed current for test of the loop
	info	Versions of hardware and software, serial number
	rES	Reset to factory settings

● 7 Troubleshooting



- Only the manufacturer should carry out repairs.



- Do not use any pointed or hard objects for cleaning to prevent damage to the electrical contacts and the lens.
- Verify in advance if the right voltage supply has been chosen.
- Biased measurements can also be created by an unsuitable grade of emissivity, caused by deviating material properties of the test object. See tables on page 30 / 31 for a list of average values usable for comparisons.

Failure	Possible cause	Procedure
No output signal	Cable break No/incorrect voltage supply	Check connectors and cable Adjust voltage supply to correspond with the operating instructions
No/false output signal product	Incorrectly wired	Follow pin assignment (see label / operating instructions)
Output signal unchanged after change in temperature	Infrared detector is defective or not aligned on test object	Replace infrared sensor or align it correctly
Output signal doesn't correspond to expectations	Device configuration is wrong	Adjust configuration
Output signal doesn't correspond to expectations	Infrared sensor is unsuitable, damaged or not aligned on the test object	Select suitable infrared detector or replace defective device or align the sensor correctly
Device shows minimum or maximum output signal respectively	Device is in error condition	See under chapter 5
Signal span erratic / imprecise	Electromagnetic interference source in the vicinity, e. g. inverter drive Working temperature too high / too low	Shield the device, shield the cables, remove the interference source Ensure permissible temperatures as per the operating instructions

Note: In case of unjustified reclamation an additional charge is possible.

Make sure the unit is working properly after every setting change. In case the error continues to exist, send the device in for repair (or replace the unit).

Returned goods: Clean dismantled devices. See also chapter 8 for more details.

8 Maintenance, Dismounting, Return, Cleaning, Disposal

8.1 Maintenance

- The METS-IR infrared temperature sensors are maintenance-free.
- Only the manufacturer should carry out repairs.

8.2 Dismounting

Create dead voltage condition on device. Disconnect electrical connections. Use chapter 4.4 in reversed order.

8.3 Return



Warning

- Before returning the device, follow the instructions in chapter 8.4.
- To return a device, use the original packaging or something comparable.
- To protect against damages, use anti-static foil, insulating material or identification as sensitive measurement equipment.

8.4 Cleaning

Clean the device regularly to prevent dust formation on device. The electrical contacts and the lens need to stay dry and clean!



- Property damage!
Abrasive agents or aggressive solvents can damage the contacts and the lens.
- Power down and create dead voltage condition on the device before cleaning.
 - Use only a soft, moist piece of cleaning cloth for cleaning.

Cleaning of lens

To avoid error in measurement, the lens of the sensor has to be cleaned periodically.



- Property damage!
Too strong mechanical stress may damage or crash the lens.
- Blow off loose particles using clean compressed air or a soft brush.
 - The lens surface can be cleaned with a soft, humid tissue moistened with water or a water based glass cleaner.
 - Take care that the lens will not be scratched

8.5 Disposal



- Dispose device components and packaging materials in accordance with the respective waste treatment and disposal regulations of the region or country to which the METS-IR is supplied.
- Collect electrical and electronic parts separately. Separate metals and plastics. Dispose of printed circuit board assemblies professionally.

● 9 Technical Data

Input

Infrared radiation: -40...1000 °C (minimum range: 100 °C)

Output

Current signal: 4...20 mA with superimposed communication signal (HART), 3-wire system

Current range: 3,8...20,5 mA

Signal on error: 3,6 mA (sensor short circuit, underflow)
21 mA (sensor break, sensor open circuit, overflow)

Performance

Infrared sensor: Spectral region: 8...14 µm
Optical resolution: 15:1
Accuracy*: ±1,5 °C, ±1,5%
Repeatability*: ±0,75 °C, 0,75%
Temperature coefficient: ±0,05 K/K, ±0,05% (ambient temperature: <18 °C, >28 °C)
Resolution: 0,1 °C
Response time: 30 ms (t90)
Warm-up time: 10 min
Emissivity, amplification: 0,100...1,100
Transmittance: 0,100...1,000

* Reference values: Temperature: ambient = 23±5 °C, test object = >0 °C / whichever is greater / ε = 1 /
response time = 1 s / Distance D = 20 cm, Measuring point S = 16,6 mm

Measuring amplifier: Accuracy: 0,3% of range
Resolution: 16 Bit
Filter setting: 0...99 s
Measuring rate: 10 measurements/s
Configuration: Keys on display / via software (HART communication)
Transmission behaviour: temperature linear
Turn-on delay time: <5 s
Reponse time: 20 ms

Indicator / limit values: Resolution: -9999...9999 digit
Error of measurement: ±0,2% of range, ±1 digit
Temperature drift: 100 ppm/K

Indication

Display: 7 segment, 8,5 mm, red, 4 digits, representation mirror-inverted 180° possible
Head of display: rotatable approx. 330°
Memory: minimum / maximum values
Indication: - measuring value - unit of measurement - control menu
Decimal point: automatically or manually, dependent on measuring range / unit

Limit Contacts

Electronically: 2x PNP or NPN (30 VDC, 200 mA)
Option: 2x PNP or NPN (30 VDC, 1000 mA)

Indication: 1 LED red for each limit value

Voltage across: <1 V

Settings: with 3 keys (TouchM-Technology)

Setting range: switch point and hysteresis: any value within measuring range

Switching delay: 0,0...999,9 s

Failsafe function: adjustable

Galvanical insulation: switching outputs are separated from measuring amplifier

● 9 Technical Data (Continued)

Supply

Voltage: 24 VDC \pm 10%
Reverse battery protection: available (no function, no damage)

Environmental Conditions

Temperature: Operating range: -20...+80 °C
Sensing head: -20...120 °C
Storing: -40...+85 °C
Air humidity: 10...95% rH (no condensation)

Mechanics

Dimensions: see page 31
Process connection: 1/2" / 3/4" / 1" / 1/2NPT
Electrical connection: M12 male, 8-pole
Material: Process connection: stainless steel 1.4571
Sensing head: stainless steel
Body: PBT GF30
Head of display: polycarbonate (makrolon)
Weight: approx. 240 g
Fitting position: any (avoid deposition on lens)
System pressure: 0 bar (barometric pressure)
Device protection: Protection class: at least IP65 (electronics)
PCB: potted
Vibration: IEC 68-2-6: 3G, 11 – 200 Hz, any axis
Shock: IEC 68-2-27: 50G, 11 ms, any axis

Programmable Features

Measuring amplifier: Measuring range start (LRV) / Measuring range end (URV) /
Adjustment, simulation of output current / Filter function / Linear output signal /
HART address / 2-point calibration
Display: range of indication / time of indication / decimal point / units /
stabilisation of zero point / locking of programming / calibration points /
TAG number
Limit contacts: limit value 1 and 2 / hysteresis 1 and 2 / delay times 1 and 2
Features, Operation: according VDMA 24574-1 up to 24574-4

● 10 Optical Charts and Emissivity (Continued)

10.1 Optical Charts

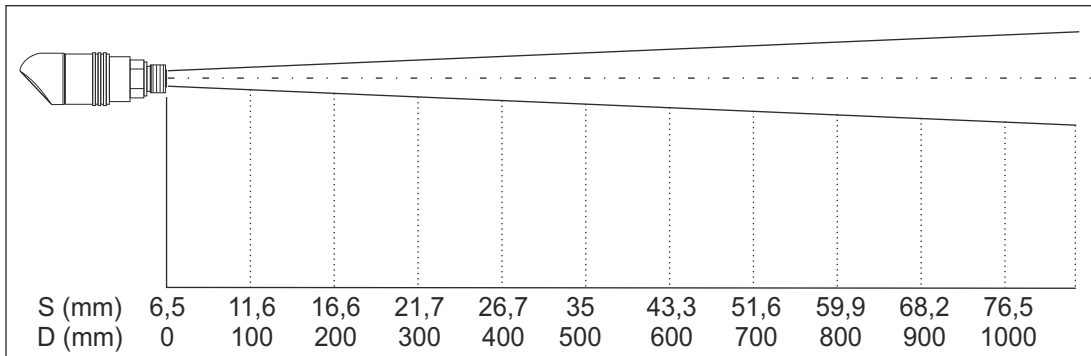

S = Measuring point size
D = Distance from sensing head front to the object
For valid measurement the point size should be as large as the object or smaller.

The optical chart above shows the diameter of the measuring spot in dependence on the distance between measuring object and sensing head. The spot size refers to 90 % of the radiation energy. The distance is always measured from the front edge of the sensor housing.

- The size of the measuring object and the optical resolution of the infrared thermometer determine the maximum distance between sensing head and measuring object.
- In order to prevent measuring errors the object should fill out the field of view of the optics completely. Consequently, the spot should at all times have at least the same size like the object or should be smaller than that.

10.2 Emissivity / Transmissivity

The emissivity (ϵ) is used as a material constant factor to describe the ability of the body to emit infrared energy. The actual emissivity of a material depends on the following factors:

- Temperature
- Measuring angle
- Geometry of the surface
- Thickness of the material
- Constitution of the surface (polished, oxidized, rough, sandblast)
- Spectral range of the measurement
- Transmissivity (e.g. with thin films)

The transmissivity is a measure for the transparency of a body: At a value of 0 any kind of light can transit the body, it is completely transparent. At a value of 1 the body absorbs totally the incident light. In this case it is also impervious to infrared.

- If the adjusted emissivity is too high, the infrared thermometer may display a temperature value which is much lower than the real temperature – assuming the measuring object is warmer than surroundings. When the measuring object is cooler than the surroundings the measuring result can be falsified by near by infrared sources.
- A low emissivity (reflective surfaces) carries the risk of inaccurate measuring results by interfering infrared radiation emitted by background objects (flames, heating systems, chamottes).
- A change of the preset emissivity is only possible on request and before delivery. A change by customer is not possible. For an alternative possibility see 10.3.
- The spectral range is determined by its design and cannot be changed.

● 10 Optical Charts and Emissivity (Continued)

10.3 Adjustment of Deviation in Emissivity and/or Transmissivity

The infrared sensor comes by default with an emissivity of 0,95 and a transmissivity of 1. If the conditions at the test object are different to this, the temperature measurement is faulty. To compensate these errors, please follow the following steps:

Example: Temperature test object: 100 °C, adjusted upper range value (URV): 300 °C

(Of course any other value is possible as test object temperature, however it must be known (measured) and adjusted)

The exact temperature of the test object has to be measured with an alternative measuring method (e.g. contact thermometer) and has to be brought to a temperature of 100 °C.

As described under „**6.3.2 Setting lower and upper ranges (SLr / Sur)**“, the upper range value is adjusted from 300 °C to the available test object temperature of 100 °C.

In the next step, as described under „**6.6.1 Adjusting lower and upper range (tLr / tur)**“, the output signal is adjusted to the available test object temperature (temperature test object: 100 °C, output signal: 20 mA, shown temperature on display: 100 °C.)

Note: The spot area of the infrared sensor has to be aligned exactly with the test object.

In the last step, as described under „**6.3.2 Setting lower and upper ranges (SLr / Sur)**“, the upper range value of 100 °C is adjusted back to the value of 300 °C. For the existing emissivity and/or transmissivity during the adjustment the output values of the METS-IR are now correctly.

● 10 Optical Charts and Emissivity (Continued)

10.4 Emissivity Tables

Note: These emissivity tables are average values only.

Emissivity Table Metals					
Material	Typical Emissivity		Material	Typical Emissivity	
Aluminium	non oxidized polished roughened oxidized	0,02-0,1 0,02-0,1 0,1-0,3 0,2-0,4	Lead	polished roughened oxidized	0,05-0,1 0,4 0,2-0,6
Chrome		0,02-0,2	Iron	non oxidized rusted oxidized forged, blunt	0,05-0,2 0,5-0,7 0,5-0,9 0,9
Iron, casted	non oxidized oxidized	0,2 0,6-0,95	Gold		0,01-0,1
Haynes (alloy)		0,3-0,8	Inconel	electro polished sandblast oxidized	0,15 0,3-0,6 0,7-0,95
Copper	polished roughened oxidized	0,03 0,05-0,1 0,4-0,8	Magnesium		0,02-0,1
Brass	polished roughened oxidized	0,01-0,05 0,3 0,5	Molybdenum	non oxidized oxidized	0,1 0,2-0,6
Monel (Ni-Cu)		0,1-0,14	Nickel	electrolytic oxidized	0,05-0,15 0,2-0,5
Platinum (black)		0,9	Mercury		0,05-0,15
Silver		0,02	Steel	polished plate rustless heavy plate cold-rolled oxidized	0,1 0,1-0,8 0,4-0,6 0,7-0,9 0,7-0,9
Titanium	polished oxidized	0,05-0,2 0,5-0,6	Wolfram (polished)		0,03-0,1
Zinc	polished oxidized	0,02 0,1	Tin (non oxidized)		0,05

● 10 Optical Charts and Emissivity (Continued)

10.4 Emissivity Tables (Continued)

Emissivity Table Non Metals			
Material	Typical Emissivity	Material	Typical Emissivity
Asbestos	0,95	Asphalt	0,95
Basalt	0,7	Concrete	0,95
Ice	0,98	Soil	0,9-0,98
Paint (non alkaline)	0,9-0,95	Gypsum	0,8-0,95
Glass plate melt	0,85 n/a	Rubber	0,95
Wood (natural)	0,9-0,95	Limestone	0,98
Carborundum	0,9	Ceramic	0,95
Grit	0,95	Carbon non oxidized graphite	0,8-0,9 0,7-0,8
Plastic (>50 µm, non transparent)	0,95	Paper (any color)	0,95
Sand	0,9	Snow	0,9
Textiles	0,95	Water	0,93

The values of these emissivity tables refer to a spectral range of 8...14 µm

● 11 Dimensions (in mm)

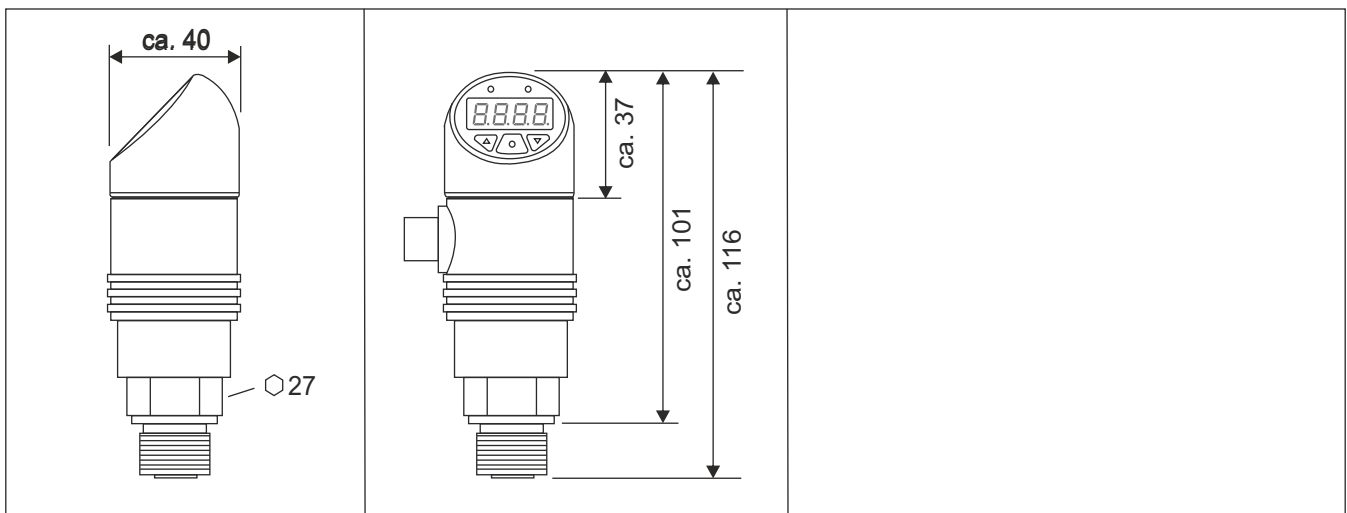

● 12 HART Communication

The HART-Tool is a graphical user interface for the with menu-driven program for configuration. It can be used for putting into operation, configuration, analysis of signals, data backup and documentation of the device. Operating systems: Windows XP, Windows 7, 8.1 and 10.

Connection via HART interface (modem) with USB interface of a PC or hand-held HART communicator

Settings:

- Adjustment of output current	- Simulation of output current	- Filter function
- Limits of measuring range	- Linear output signal	- HART address
- HART TAG number	- 2-point calibration	

Please note: When using communication via a HART modem, a communication resistance of 250 Ω has to be taken into account.

● 13 Accessories

Interface HART, USB, software

Order No.: **01310-00220**