

Operating Instructions



1 General Information	2
1.1 General Safety Notes.....	2
1.2 Intended Use.....	2
1.3 Conformity with EU Regulations.....	2
1.4 ATEX Approval.....	2
2 Transportation and Storage	2
3 Installation and Commissioning	2
3.1 Mechanical Installation	3
3.2 Electrical Connection	3
4 Operation	3
4.1 Zero-point correction	4
4.2 Devices with Diaphragm Seal	4
4.3 Maintenance / Service.....	4
5 Disassembly	5

1 General Information

This document contains necessary information for the proper installation and use of this device. In addition to this instruction, be sure to observe all statutory requirements, applicable standards, the additional technical specifications on the accompanying data sheet (see www.labom.com) as well as the specifications indicated on the type plate.

1.1 General Safety Notes

The installation, set up, service or disassembly of this device must only be done by trained, qualified personnel using suitable equipment and authorized to do so.



Warning

Media can escape if unsuitable devices are used or if the installation is not correct.

Danger of severe injury or damage

- Ensure that the device is suitable for the process and undamaged.

1.2 Intended Use

The device is intended to measure pressure of gases, vapors and liquids as specified in the data sheet.

1.3 Conformity with EU Regulations

The CE-marking on the device certifies its compliance with the applicable EU Directives for placing products on the market within the European Union.

You find the complete EU Declaration of Conformity (document no. KE_021) at www.labom.com.

1.4 ATEX Approval

Devices of the type Cx1xx1 or Cx2xx1 are certified for use in explosive environments.

If you purchased a device with ATEX approval, please refer to the accompanying document XA_007 for ATEX-relevant information.

2 Transportation and Storage

Store and transport the device only under clean and dry conditions preferably in the original packaging. Avoid exposure to shocks and excessive vibrations.

Permissible storage temperature: -25...85 °C

3 Installation and Commissioning

Ensure that the device is suitable for the intended application with respect to pressure range, overpressure limit, media compatibility, temperature range and process connection.

3.1 Mechanical Installation

Before starting operation, check the process connection carefully for leaks under pressure. Use gaskets, if required, that are suitable for the process connection and resistant to the media.

You can use the device in any mounting position. Normally the transmitter is adjusted for a vertical mounting position. A different mounting position in combination with a small nominal range might cause a zero point offset. In this case a zero point adjustment might be necessary.

The device is ventilated via the connecting cable with a degree of IP67 protection and pressure ranges up to 16 bar / 250 psi. During installation lay a ventilated cable to an aeratable connection room. This compensates any atmospheric fluctuations.

3.2 Electrical Connection

Complete the mechanical installation before you connect the device electrically. Set up all electrical connections while the voltage supply is switched off.

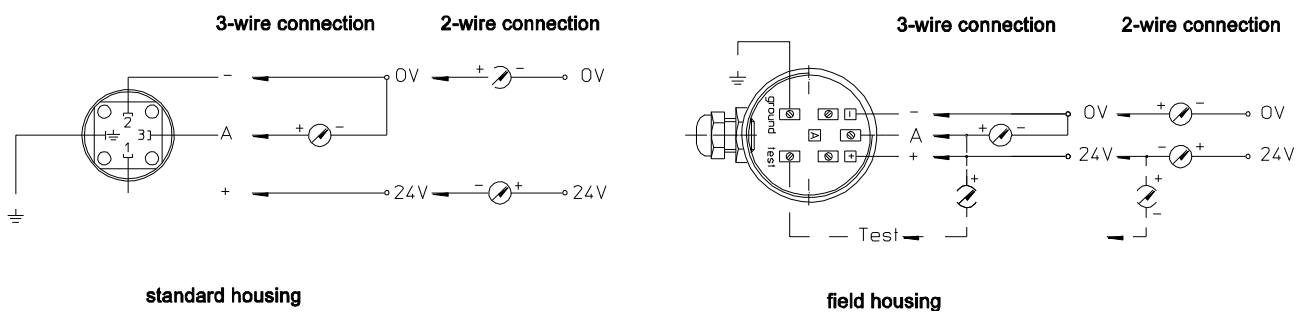

Figure 1: Options of the electrical connection

4 Operation

During operation, take care that the device remains within its intended pressure and temperature ranges. No other monitoring is necessary.

The permissible ambient and media temperature depends on the type of device and its design. This information can be found in the relevant data sheet.

4.1 Zero-point correction

If a subsequent zero point correction becomes necessary the potentiometers can be accessed in the model with field housing by unscrewing the locking ring. In the model with electrical plug the potentiometers can be accessed beneath the cap. The potentiometer for the zero point (zero) and range (span) can be adjusted with a screwdriver (1.5x40). 10 revolutions correspond to approx. $\pm 10\%$ of the measurement range. An exact reference pressure should be applied to align the measurement range.

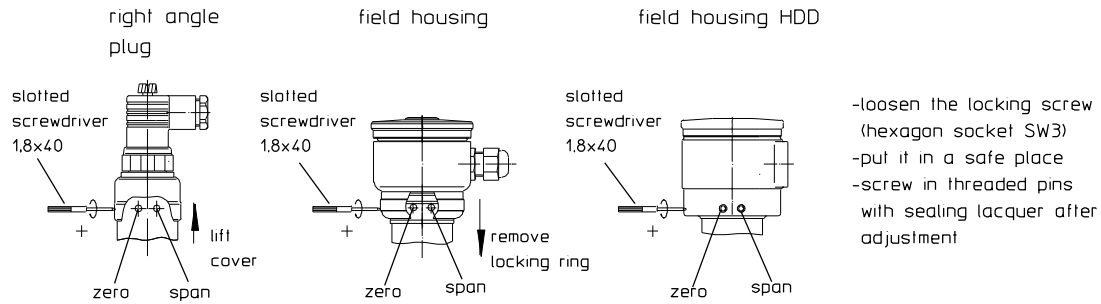

Figure 2: Zero-point correction

4.2 Devices with Diaphragm Seal

Remove the protective cap or protective wrapping from the diaphragm only just before installation to prevent contamination or damage.

The diaphragm must not be touched. Do not place the device on its diaphragm. Even small scratches or deformations may negatively influence the zero point or other characteristics of the device.

Pressure transmitter and diaphragm seal are a closed system that must not be separated. You can find further information about diaphragm seals in the document TA_031 on www.labom.com.

4.3 Maintenance / Service

When properly installed in accordance with applicable specifications, this device is maintenance-free. However, we recommend an annual recalibration of the device.

In the event of any damage or defect the customer cannot replace or repair any components or assemblies.

5 Disassembly

When measuring hot media, make sure that the device has cooled down prior to any dismounting or wear appropriate protective clothing to avoid burns.

Switch off the power supply to the device before disconnecting the electrical connections. Once this is done, the device may be mechanically removed.



Warning

Opening pressurized lines might cause severe injuries.

Danger of severe injuries or damage

- Relieve the process pressure before attempting to remove the device. Shut off the pressure supply for all feed lines to the device and relieve the pressure in them.



Warning

Hazardous deposits and residues might remain on opened process connections and removed devices.

Danger of injury

- After the device has been removed, seal off the measuring point and mark the open process connection accordingly. Consider a possible danger due to residues when handling the removed device.