



DOC023.52.00051

9184sc Chlorine 9185sc Ozone and 9187sc Chlorine Dioxide Analyzer

User Manual

01/2018, Edition 3

Table of Contents

Section 1 Specifications	3
Section 2 General Information	5
2.1 Safety Information	5
2.1.1 Use of Hazard Information	5
2.1.2 Precautionary Labels	5
2.2 General Sensor Information	6
2.3 Theory of Operation.....	6
Section 3 Installation	9
3.1 Mounting the Analyzer.....	9
3.1.1 Environmental Considerations	9
3.1.2 General Installation Considerations	10
3.2 Choosing the Sample Line Location.....	10
3.3 Connecting the Sample Stream.....	10
3.4 Connecting the Waste Stream.....	11
3.5 Assembling and Placing the Probe.....	11
3.5.1 Probe Assembly.....	11
3.5.1.1 Placing the Probe Into the Flow Thru Assembly.....	13
3.5.1.2 Using the Optional pH (9184sc TFC only).....	15
3.6 Connecting the Sensor with the sc Controller	15
3.6.1 Attaching a sc Sensor with a Quick-connect Fitting	15
3.7 Instrument and Controller Startup.....	16
Section 4 Operation	19
4.1 Using the sc Controller	19
4.2 Sensor Data Logging.....	19
4.3 Sensor Setup.....	19
4.3.1 Changing the Sensor Name and Parameter Selection	19
4.4 Sensor Diagnostics Menu.....	20
4.5 Sensor Setup Menu.....	20
4.6 Calibration	21
4.6.1 Temperature Sensor Calibration	21
4.6.1.1 Adjusting the Temperature	22
4.6.2 pH (9184sc T.F.C. or 9184sc Chlorine + Acid only)	22
4.6.2.1 Process pH 1 Point Sample.....	22
4.6.2.2 Process pH 2 Point Sample.....	23
4.6.3 Concentration Calibration	23
4.6.3.1 Process Calibration	24
4.6.4 Zero Calibration	24
4.6.4.1 Chemical Zero Calibration	25
4.6.5 Calibration Configuration	25
4.7 Set Calibration Defaults	25
Section 5 Maintenance	27
5.1 Maintenance Schedule.....	27
5.2 Scheduled Maintenance.....	27
5.2.1 Replacing the Membrane.....	27
5.2.2 Replacing the Tubing	28
5.2.3 Replacing the Electrolyte	28
5.2.4 Replacing the pH Electrode (9184sc only).....	28

Table of Contents

Section 6 Troubleshooting	29
6.1 Error Messages	29
6.2 Warning Messages	29
Section 7 Replacement Parts and Accessories	31
7.1 Replacement Parts, Sensor Only	31
7.2 Replacement Parts	31
7.3 Optional Accessories	31
7.4 Extension Cables	32
Section 8 Warranty, liability and complaints	33
Appendix A 9184sc Theory of Operation	35
A.1 Theory of Operation	35
A.1.1 Principle of Operation	35
Appendix B 9185sc Theory of Operation	37
B.1 Theory of Operation	37
B.1.1 Principle of Operation	37
Appendix C 9187sc Theory of Operation	39
C.1 Theory of Operation	39
C.1.1 Principle of Operation	39
Appendix D Modbus Register Information	41

Section 1 Specifications

Specifications are subject to change without notice

General			
Mounting	Flat, vertical surface such as a wall, panel, stand, etc.		
Analyzer Dimensions	10.63 x 9.84 in. (270 x 250 mm)		
Analyzer Weight	6.5 kg (14.3 lb)		
Materials	Electrode: gold cathode/silver anode; probe body: PVC; measuring cell: acrylic		
Sample Requirements			
Sample Flow Rate to Analyzer	Flow rate should allow for 14 L/hr minimum		
Minimum Inlet Pressure to Instrument	0.1–2 bar (1.4–28 psi)		
Minimum Flow Rate	14 L/hr auto-regulated by flow thru cell		
Pressure Range	0.1–2 bar (1.4–28 psi) influent; flow cell pressure will be the atmospheric pressure		
Sample Temperature Range	+2–45 °C (35.6–113 °F)		
Temperature Compensation	Automatic over the sample Temperature Range		
Sample pH	4 to 8 (acidification unit available for >8 pH)		
Sample Inlet Tubing: at instrument	¼ in. OD		
Drain Fitting	½ in. ID (supplied)		
Application Sample	Clean water		
Electrical			
Power Consumption	12 V, 1.5 Watts provided by sc controller		
Performance			
	9184sc	9185sc	9187sc
Measurement Range	0–20 ppm (0–20 mg/L) HOCl	0–2 ppm (0–2 mg/L) O ₃	0–2 ppm (0–2 mg/L) ClO ₂
Detection Limit	5 ppb (0.005 mg/L) HOCl	5 ppb (0.005 mg/L) O ₃	10 ppb (0.01 mg/L) ClO ₂
Accuracy	2 % or ±10 ppb HOCl, whichever is greater	3 % or ±10 ppb O ₃ , whichever is greater	5 % or ±10 ppb ClO ₂ , whichever is greater
Standard Deviation	0.7 %	1.0 %	1.5 %
Interference	No interference from chloramines. Ozone and chlorine dioxide interfere with measurement.	No interference from chlorine, chloramines, hydrogen peroxide, bromine, or chlorine dioxide.	None
Repeatability	±10 ppb (0.01 mg/L) or ±5 %, whichever is greater at a pH < 7.5		
Response Time	90 % < T=90 seconds		
Measurement Interval	Continuous		
Measurement Technology	Amperometric/Membrane (electrode, membrane, electrolyte)		
Calibration	Electrical zero or chemical zero with dechlorinated or deoxygenated water; calibration of the slope by comparison with a laboratory instrument; pH calibration (9184sc only) with Single or Two Point using standards or comparison with lab method with the process sample.		
Calibration Interval	2 months for typical application		
Maintenance			
Maintenance Interval, Measurement Cell	6 months for the membrane and electrolyte for typical operation (3 to 12 month range)		
Maintenance Interval, pH	1 to 1.5 years for typical operation		

Specifications

Environmental (sc Analyzer)	
Enclosure	IP66/NEMA 4X
Storage Temperature Range	-20 to 60 °C (-4 to 140 °F)
Operating Temperature Range	0 to 45 °C (32 to 113 °F)
Relative Humidity	10 to 90% non-condensing
Operating Humidity	0 to 90% non-condensing
Compliance	
The sc analyzer and sensor combination are: CE marked and declared by HACH LANGE to the applicable EU Safety and EMC Directives.	

Section 2 General Information

2.1 Safety Information

Please read this entire manual before unpacking, setting up, or operating this equipment. Pay attention to all danger and caution statements. Failure to do so could result in serious injury to the operator or damage to the equipment.

To ensure that the protection provided by this equipment is not impaired, do not use or install this equipment in any manner other than that specified in this manual.

2.1.1 Use of Hazard Information

DANGER

Indicates a potentially or imminently hazardous situation which, if not avoided, could result in death or serious injury.

CAUTION









Indicates a potentially hazardous situation that may result in minor or moderate injury.

Important Note: Information that requires special emphasis.

Note: Information that supplements points in the main text.

2.1.2 Precautionary Labels

Read all labels and tags attached to the instrument. Personal injury or damage to the instrument could occur if not observed

	This symbol, if noted on the instrument, references the instruction manual for operation and/or safety information.
	Electrical equipment marked with this symbol may not be disposed of in European public disposal systems after 12 August of 2005. In conformity with European local and national regulations, European electrical equipment users must now return old or end-of life equipment to the Producer for disposal at no charge to the user. Note: For all electrical products (marked or unmarked) which are supplied or produced by Hach-Lange, please contact the local Hach-Lange sales office for instructions for proper disposal.
	This symbol, when noted on a product enclosure or barrier, indicates that a risk of electrical shock and/or electrocution exists.
	This symbol, when noted on the product, identifies the location of a fuse or current limiting device.
	This symbol, when noted on the product, indicates that the marked item can be hot and should not be touched without care.
	This symbol, when noted on the product, indicates the presence of devices sensitive to Electro-Static Discharge and indicates that care must be taken to prevent damage to them.
	This symbol, when noted on the product, identifies a risk of chemical harm and indicates that only individuals qualified and trained to work with chemicals should handle chemicals or perform maintenance on chemical delivery systems associated with the equipment.
	This symbol, if noted on the product, indicates the need for protective eye wear.
	This symbol, when noted on the product, identifies the location of the connection for Protective Earth (ground).

2.2 General Sensor Information

The system consists of a controller with an integrated display, and a sensor (Figure 2). The choice can be made to use this instrument with the specifications and processes of the 9184sc, 9185sc, or 9187sc sensor. This is determined by selecting the parameter during the initial sensor setup and the type of sensor being used. See 4.3 Sensor Setup on page 19.

2.3 Theory of Operation

Refer to the following Appendices.

- Appendix A 9184sc Theory of Operation on page 35
- Appendix B 9185sc Theory of Operation on page 37
- Appendix C 9187sc Theory of Operation on page 39

Figure 1 Sensor Cell Operation*

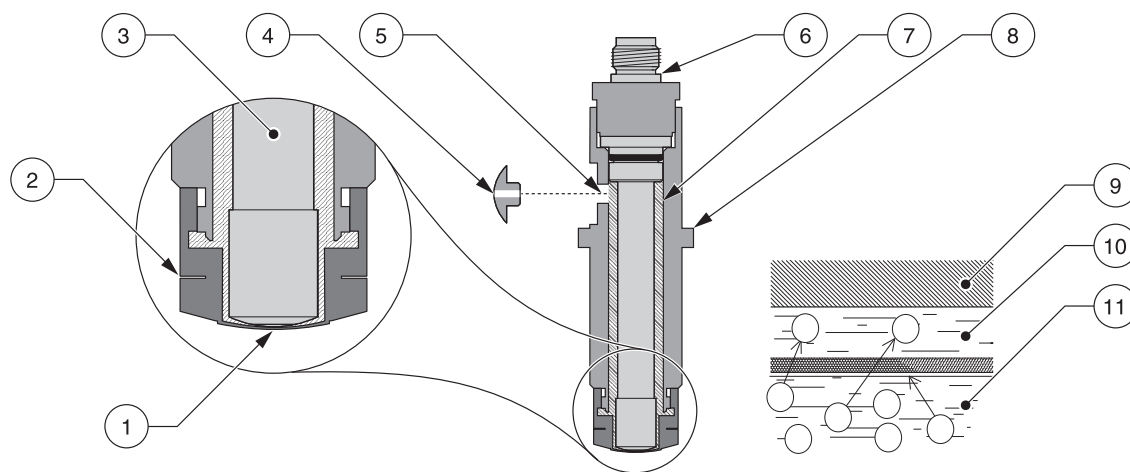

1. Membrane	7. Electrolyte
2. Membrane Holder	8. Probe Body
3. Anode	9. Cathode
4. Electrolyte Filling Plug ¹	10. Membrane/Interface Sample
5. Electrolyte Filling Hole	11. Sample
6. Assembled Electrode	

¹ A small hole exists in the plug to allow the instrument to maintain a consistent pressure regardless of changes in atmospheric pressure.

*See Replacement Parts and Accessories on page 31.

Figure 2 General Instrument Schematic**

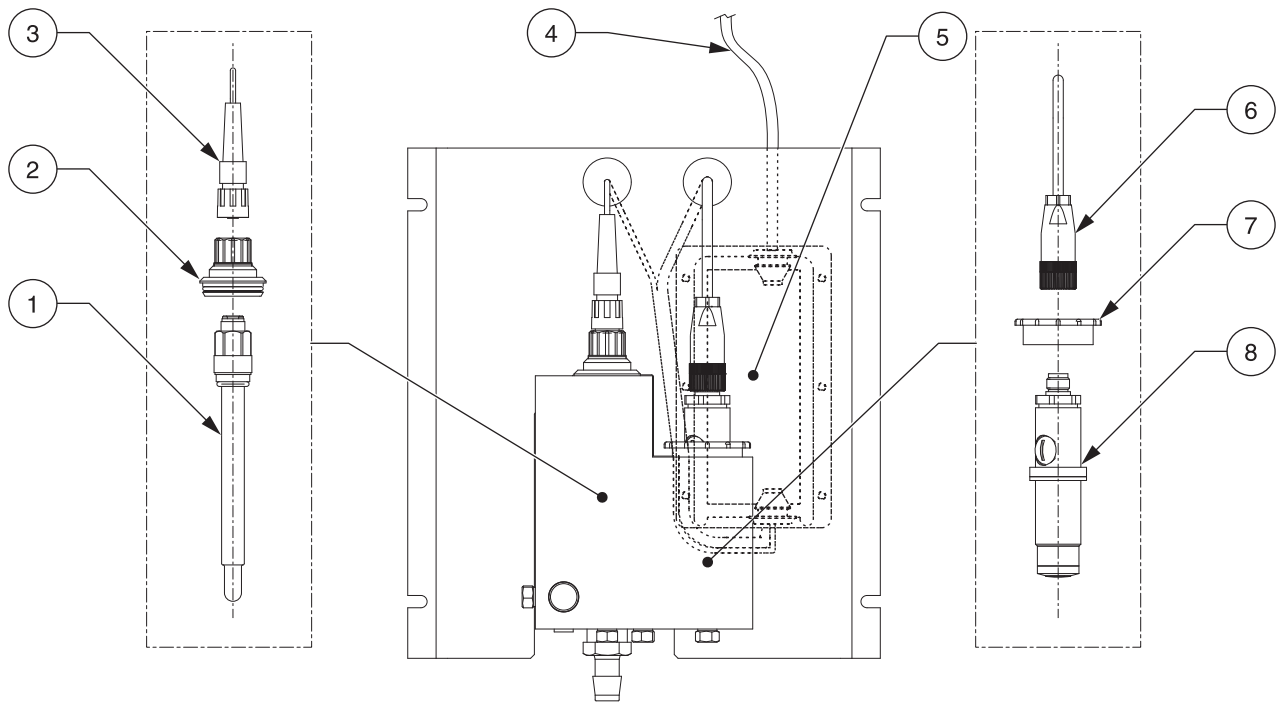

1. pH Probe (9184sc only)	5. Gateway (behind Mounting Plate)
2. pH Cell Cap (9184sc only)	6. Connector
3. Connector	7. Cell Cap
4. Cable to Controller	8. Probe Body

**See Replacement Parts and Accessories on page 31.

Section 3 Installation

DANGER

Only qualified personnel should conduct the tasks described in this section of the manual.

3.1 Mounting the Analyzer

The analyzer is designed to be mounted on a flat, vertical surface such as a wall, panel, stand, etc. The instrument must be level.

Locate the sensor as close to the sampling point as possible. The shorter the distance traveled by the sample, the faster the instrument can respond and indicate changes in sample concentration. The 152 mm (6-inch) clearance at the bottom of the instrument is not necessary if using the accessories. Refer to [section 3.3 on page 10](#) for sample stream connection instructions.

Figure 3 Analyzer Dimensions

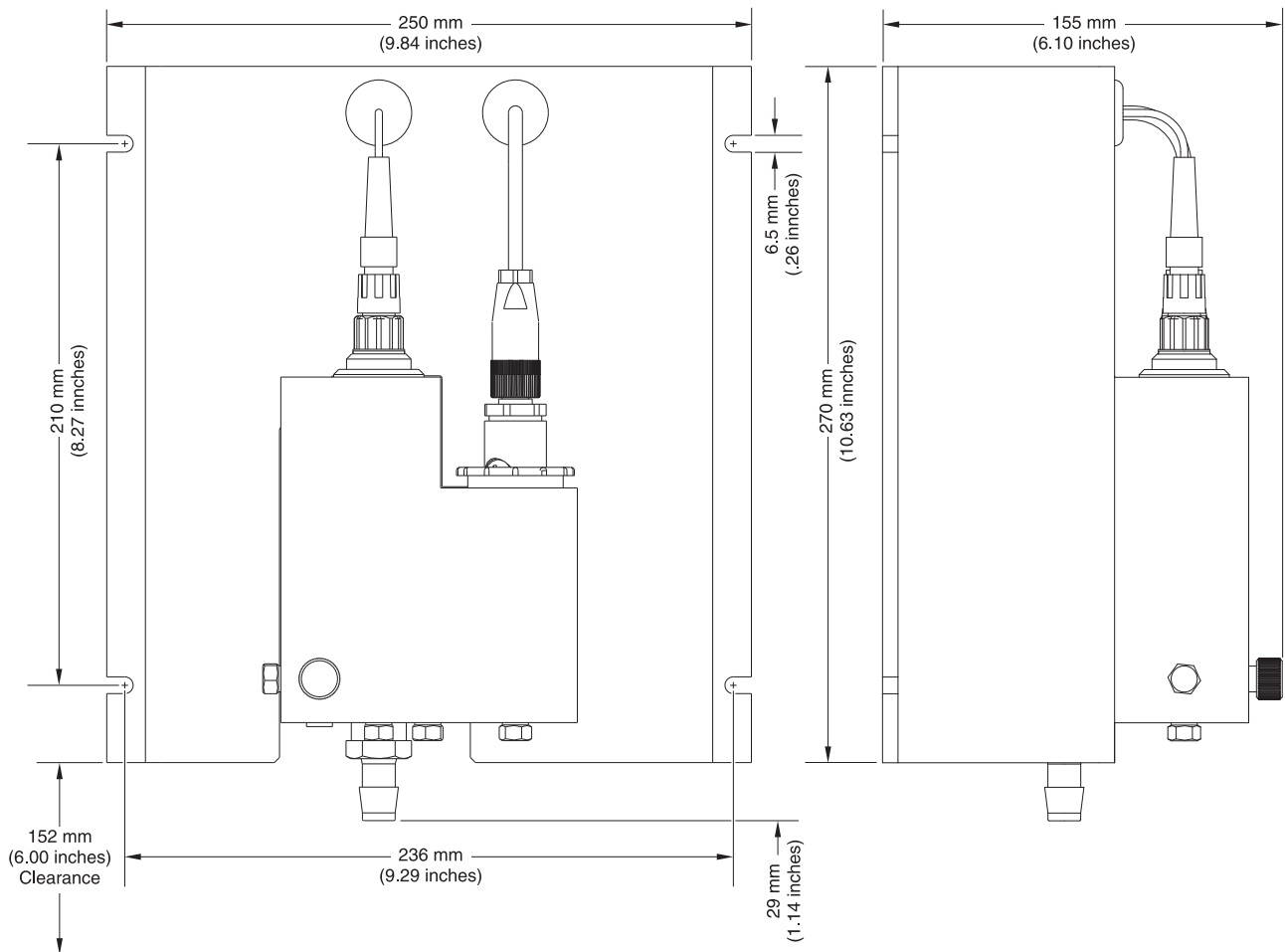

Note: The optional pH probe is used for the 9184sc TFC only.

3.1.1 Environmental Considerations

The instrument enclosure is IP66/NEMA 4X with an ambient temperature between 0 and 45 °C (32 to 113 °F), see [Specifications on page 3](#) for more information.

3.1.2 General Installation Considerations

- Place the analyzer in an accessible location.
- Keep the sample tubing as short as possible to minimize lag time.
- Do not place the probe next to a heat source.
- Ensure that there is no air intrusion into the sample supply line.
- Sample pressure must be sufficient to ensure a continuous supply to the probe. A minimum pressure of approximately 0.1–2 bar (1.4–28 psi) is sufficient to provide the correct flow rate. A stable flow rate of 200–250 mL/min is critical. Erratic flow rates will create erratic measurements.

3.2 Choosing the Sample Line Location

Note: Erratic readings will occur if a sample is drawn from a location that is too close to points of chemical additions to the process stream, if mixing is inadequate, or if the chemical reaction is incomplete.

Selecting a good, representative sampling point is important for optimum instrument performance (Figure 4). The sample analyzed must be representative of the condition of the entire system.

Install sample line taps into the side of larger process pipes to minimize the chance of ingesting sediment from the pipe line bottom or air bubbles from the top. A tap projecting into the horizontal center of the pipe is ideal.

Figure 4 Sample Line Location in the Process Stream

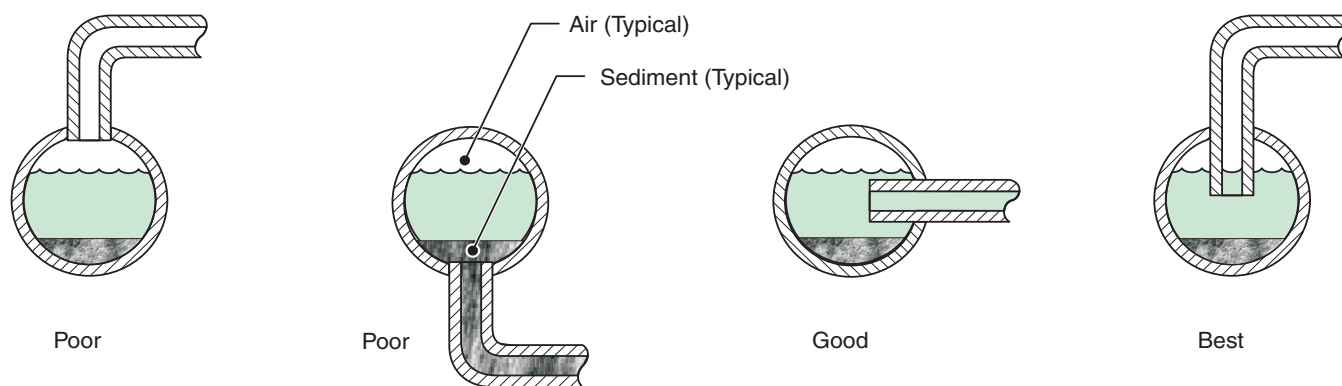

3.3 Connecting the Sample Stream

Sample inlet and drain connections are made on the Analyzer Flow Cell. Refer to [Specifications on page 3](#) for flow rates.

The sample inlet requires 6.3 mm (¼ in.) OD tubing. The connections are made with a quick connect fitting. Use the 6.3 mm (¼ in.) supplied tubing adapter in the electrode kit. Cut all tubing so the ends are squarely cut and not angled.

1. Push the tubing into the influent of the flow analyzer (Figure 5).
2. Push the supplied drain tubing onto the nipple beside the influent.
3. Ensure there are no bends in the tubing to prevent back pressure.

3.4 Connecting the Waste Stream

Connect the waste stream using the supplied ½-inch ID tubing. Be sure the drain is free flowing (free of obstructions) so that the waste stream does not cause unnecessary back-pressure or overflow.

Note: Waste from this instrument must go to the drain.

3.5 Assembling and Placing the Probe

Refer to [Figure 5](#) for a detailed description of the probe components.

Figure 5 Probe Components*

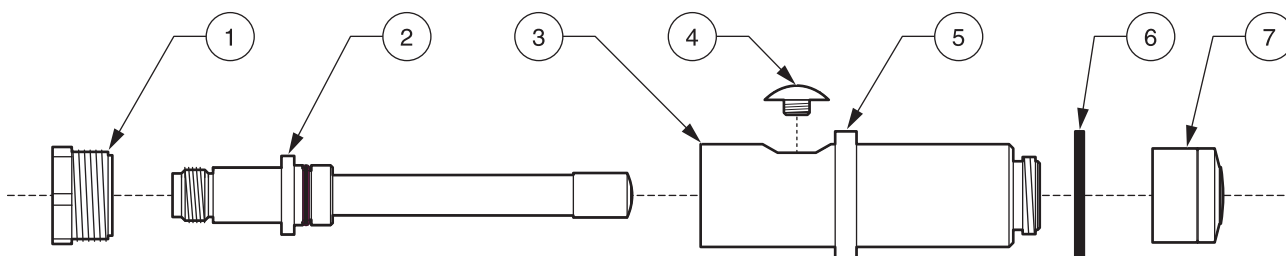

1.	Electrode Retaining Ring
2.	Measurement Electrode
3.	Probe Body
4.	Filling Screw
Note: A small hole exists in the plug to allow the instrument to maintain a consistent pressure regardless of changes in atmospheric pressure.	
5.	Flange
6.	Probe Body Washer
7.	Pre-Mounted Membrane (set of four); Ensure the properly marked membrane is chosen (e.g. CL will appear on the side for a Chlorine membrane).

3.5.1 Probe Assembly

CAUTION

To familiarize yourself with handling precautions, dangers and emergency procedures, always review the Material Safety Data Sheets prior to handling containers, reservoirs, and delivery systems that contain chemical reagents and standards. Protective eye wear is always recommended when contact with chemicals is possible.

1. Screw the membrane cap onto the probe body ([Figure 6](#) and [Figure 7](#)). Be careful not to touch or damage the membrane surface.
2. Remove the filling screw from the probe body.
3. Visually inspect the electrolyte to ensure that there are no particles or other impurities present.
4. Using the supplied syringe, fill the probe body with ~7 mL of electrolyte.
5. Slowly insert the electrode into the probe body. Do not use force when inserting into the probe body.

*See [Replacement Parts and Accessories](#) on page 31.

Installation

6. Tap the side of the probe to make sure that no air bubbles are trapped in the probe body when inserting the electrode.
7. Screw on the retaining ring. Some electrolyte may spill out the top of the body.
8. Insert the filling screw.
9. Wash hands and rinse sensor to remove excess electrolyte.
10. Place the probe into the Flow Thru Assembly.

Figure 6 Probe Assembly

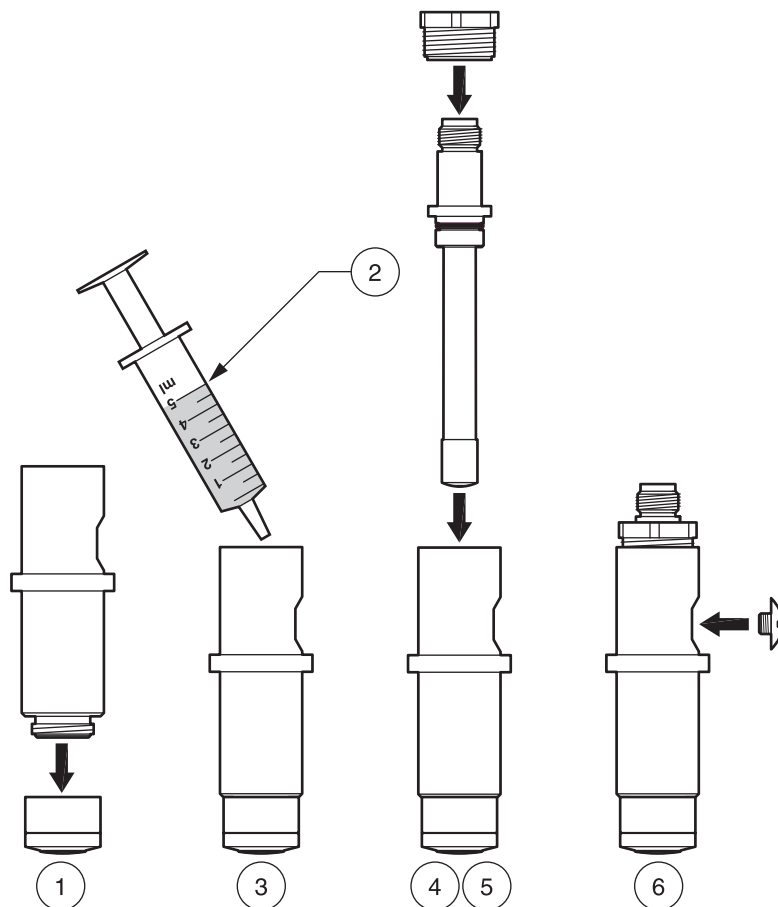

1. Membrane Cap to Probe Body	4. Seat Electrode into Probe Body.
2. Syringe Filled with 5 mL Electrolyte	5. Secure Electrode with Retaining Ring.
3. Inject Electrolyte into Electrode Body.	6. Insert Filling Screw ¹ .

¹ A small hole is in the plug so the instrument can maintain consistent pressure regardless of atmospheric pressure changes.

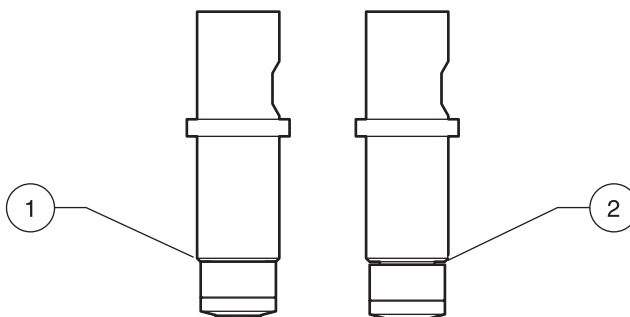
Figure 7 **Tightening the Membrane**

1. Displays the correct way to tighten the membrane. It is snug but not overtightened.

2. Displays the incorrect way to tighten the membrane. It is too loose and the internal electrolyte could leak.

3.5.1.1 Placing the Probe Into the Flow Thru Assembly

1. Remove the probe retaining nut ([Figure 8](#)).
2. Insert the newly assembled probe into the right chamber of the flow cell.
3. Gently screw the retaining nut back on, ensuring it is snug but do not overtighten.
4. Attach the keyed electrode.

Figure 8 **Placing the Probe Into the Flow Thru Assembly****

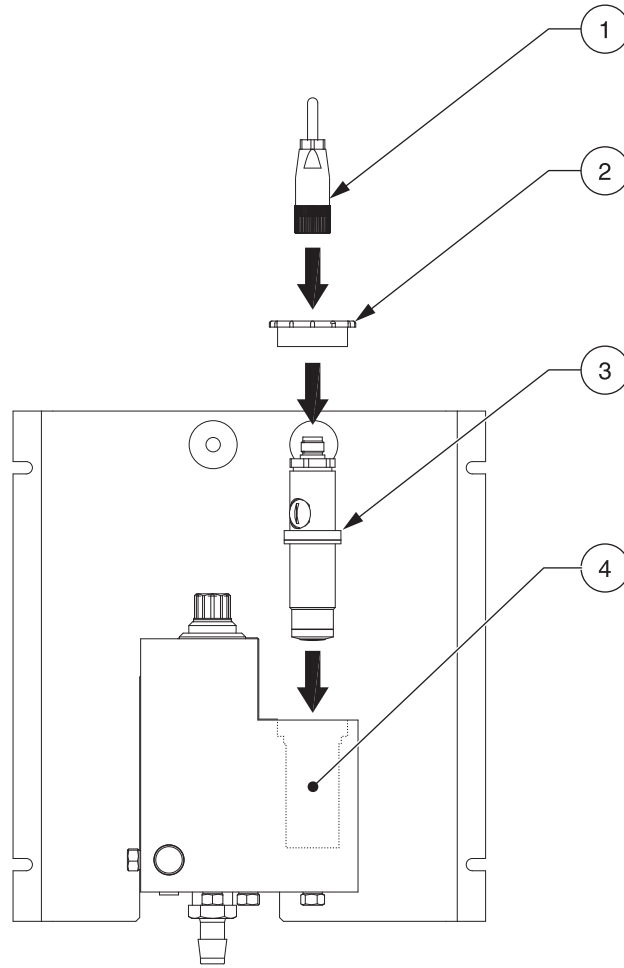

1. Electrode Cable Connector	3. Probe Assembly
2. Probe Retaining Nut	4. Flow Thru Assembly

**See Replacement Parts and Accessories on page 31.

3.5.1.2 Using the Optional pH (9184sc TFC only)

The optional pH (Figure 2 on page 7) is used when analysis is needed for measuring all of the free available chlorine (both HOCl and OCl⁻). See 4.3 Sensor Setup on page 19 for selecting this option using the controller during initial sensor parameter selection.

1. Remove the red cap from the left side of the flow cell.
2. Remove the O-ring from the white blank.
3. Gently remove the cover from the pH probe.
4. Put the O-ring from Step 2 onto the pH probe, sliding it gently over the glass end and up the probe until it is flush against the red connection.
5. Insert the newly assembled probe into the left chamber of the flow cell.
6. Attach the keyed electrode cable.

3.6 Connecting the Sensor with the sc Controller

3.6.1 Attaching a sc Sensor with a Quick-connect Fitting

The sensor cable is supplied with a keyed quick-connect fitting for easy attachment to the controller (Figure 9). Retain the connector cap to seal the connector opening in case the sensor must be removed. Optional extension cables may be purchased to extend the sensor cable length. If the total cable length exceeds 100 m (300 ft), a termination box must be installed.

Note: Use of a load termination box other than Cat. No. 5867000 may result in a hazard.

Figure 9 Attaching the Sensor using the Quick-connect Fitting

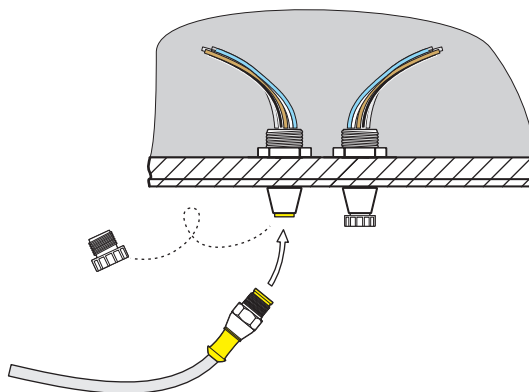
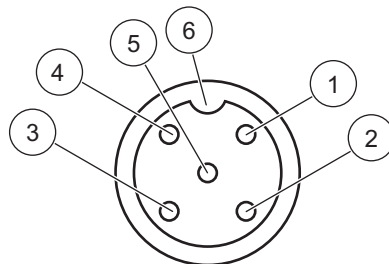

Figure 10 Quick-connect Fitting pin assignment



Number	Designation	Wire Color
1	+12 VDC	Brown
2	Circuit Common	Black
3	Data (+)	Blue
4	Data (-)	White
5	Shield	Shield (grey wire in existing quick-disconnect fitting)
6	Groove	

3.7 Instrument and Controller Startup

1. Ensure the flow regulator is threaded (clockwise) all the way and is snug but not overtightened.
2. Turn on the sample stream.
3. Slowly open the flow regulator (Figure 11) counterclockwise until consistent flow is achieved at a rate in which the flow cell can be flushed out for about two minutes. Check for leaks at this time. If leaks occur, fix by ensuring all connections are snug but not overtightened.
4. Adjust the flow regulator on the flow cell until the water begins to drain out the left drain port. This results in a constant 14 L/hour (200–250 mL/min) flow rate.
5. Supply power to the controller and it will automatically power on.
6. Allow the instrument to stabilize before proceeding. This usually takes between 2–48 hours.

Figure 11 **Setting the Flow Rate**

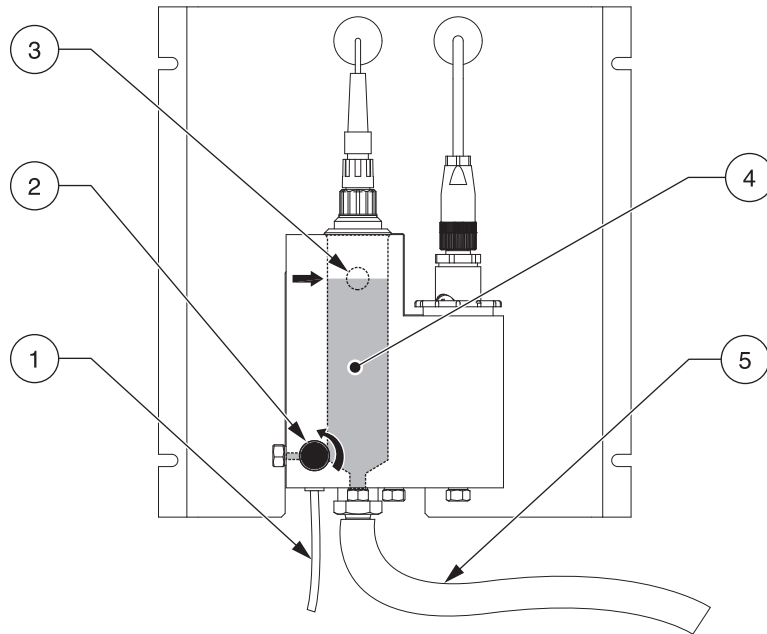

1. Sample inlet tubing	4. Sample
2. Flow meter adjustment knob	5. Drain tubing
3. Sample level overflow (indicates the correct water level)	

Section 4 Operation

4.1 Using the sc Controller

Before using the sensor in combination with an sc controller make yourself familiar with the operating mode of the controller. Refer to the controller user manual and learn how to use and navigate the menu functions.

4.2 Sensor Data Logging

The sc controller provides one data log and one event log for each sensor. The data log stores the measurement data at selected intervals. The event log stores a variety of events that occur on the devices such as configuration changes, alarms, warning conditions, etc. The data log and the event log can be read out in a CSV format. For downloading the logs please refer to the controller user manual.

4.3 Sensor Setup

Select the parameter during the initial sensor setup for the parameter that corresponds to the instrument that has been purchased. Parameter choices, depending on the instrument, are:

- Chlorine HOCL, does not include pH measurement
- Chlorine + Acid which is HOCL plus the acid verification accessory, does not include pH measurement
- Total Free Chlorine (TFC), includes pH measurement
- Ozone, does not include pH measurement
- Chlorine Dioxide, does not include pH measurement

When a sensor is initially installed, the sensor name will display. To change the sensor name refer to the following instructions:

4.3.1 Changing the Sensor Name and Parameter Selection

When a sensor is initially installed, the sensor name will be displayed. To change the sensor name refer to the following instructions:

1. From the Main Menu, select SENSOR SETUP and confirm.
2. Highlight the appropriate sensor if more than one sensor is attached and confirm.
3. Select CONFIGURE and confirm.
4. Select EDIT NAME and edit the name. Confirm or cancel to return to the Sensor Setup menu.
5. Select PARAMETER and confirm.
6. Choose the parameter the instrument purchased corresponds to and confirm.

4.4 Sensor Diagnostics Menu

SELECT SENSOR
ERROR LIST —See section 6.1 on page 29 .
WARNING LIST — See section 6.2 on page 29 .

4.5 Sensor Setup Menu

SELECT SENSOR (if more than one sensor is attached)
CALIBRATE
ZERO CAL
See section 4.6.4 on page 24 .
PROCESS CONC
Use to adjust concentration which requires accurate pH; and TFC in ppb. See section 4.6.3 on page 23 .
PROCESS TEMP
Use to adjust the TEMPERATURE for a °C value. See section 4.6.1.1 on page 22 .
PROCESS PH (9184sc T.F.C. or 9184sc Chlorine + Acid only)
Use to adjust for a 1 or 2 Point Process pH Sample. See section 4.6.2.1 on page 22 and section 4.6.2.2 on page 23 .
CAL CONFIG
Select OUTPUT MODE, CAL ZERO, or CAL DELAY. For the OUTPUT MODE, select ACTIVE, HOLD, TRANSFER, or CHOICE. For CAL ZERO, select ELECTRICAL or CHEMICAL. For CHEMICAL use a sample that does not contain any oxidants. Ensure that the sample source has a sufficient flow rate and that the sample is adequately mixed. CAL DELAY can adjust for Days. See section 4.6.5 on page 25 .
DEFAULT SETUP
Resets the sensor configuration to default settings. See section 4.7 on page 25 .
CONFIGURE
EDIT NAME
Enter up to a 10-digit name in any combination of symbols and alpha or numeric characters.
SELECT PARAM.
Select CHLORINE HOCL, CHLORINE + ACID, T.F.C., OZONE, or CHLORINE DIOX.
CONC UNITS
Select for ppb–ppm and ug/l–mg/l
T-SENSOR
The sensor has a factory-set internal temperature. Select AUTOMATIC or MANUAL setting. The preferred setting is AUTOMATIC.
TEMP UNITS
Select °C or °F.
SAMPLE PH (9184sc Chlorine + Acid only)
Allows user to set the pH of the sample.
SELECT PH MEAS (9184sc T.F.C or 9184sc Chlorine + Acid only)
AUTOMATIC or MANUAL setting and pH compensation. Use the AUTOMATIC setting when using supplied pH.

4.5 Sensor Setup Menu (continued)

DISP PH FORMAT (9184sc T.F.C or 9184sc Chlorine + Acid only)
Choose either XX.XX pH or XX.X pH.
pH MAXIMUM (9184sc T.F.C only)
Allows user to set the maximum pH allowed value. An higher value will display a PH TOO HIGH error message.
LOG SETUP
Allows user to select data logging interval for the sensor and temperature.
FILTER
Adjust for + s. This averages the signal over the specified time interval.
MAINS FREQ
Choose 50 or 60 Hz.
CONFIGURE (continued)
DEFAULT SETUP
Resets the sensor configuration to default settings.
DIAG/TEST
PROBE INFO
Displays the driver and software versions and the serial number.
CAL DATA
Displays OFFSET: °C, SLOPE: in A/mg and OFFSET: uA, SLOPE: %
SIGNALS
Displays INT, TEMP RAW, MV RAW and PH RAW.
COUNTERS
Displays sensor total time and humidity suppressor.

4.6 Calibration

4.6.1 Temperature Sensor Calibration

The probe contains a temperature sensor which is factory pre-set. If there are setting questions, the data can be validated using a high precision thermometer using [Table 1](#) and performing the steps in [section 4.6.1.1 on page 22](#).

Temperature Conversion

Conversion from Celsius to Fahrenheit: °F = 1.8 x °C + 32

Conversion from Celsius to Kelvin: K = °C + 273.15

Table 1 Temperature Conversions

°C	°F	K	°C	°F	K	°C	°F	K
0	32	273.15	16	60.8	289.15	32	89.6	305.15
1	33.8	274.15	17	62.6	290.15	33	91.4	306.15
2	35.6	275.15	18	64.4	291.15	34	93.2	307.15
3	37.4	276.15	19	66.2	292.15	35	95	308.15
4	39.2	277.15	20	68	293.15	36	96.8	309.15
5	41	278.15	21	69.8	294.15	37	98.6	310.15
6	42.8	279.15	22	71.6	295.15	38	100.4	311.15
7	44.6	280.15	23	73.4	296.15	39	102.2	312.15
8	46.4	281.15	24	75.2	297.15	40	104	313.15
9	48.2	282.15	25	77	298.15	41	105.8	314.15
10	50	283.15	26	78.8	299.15	42	107.6	315.15
11	51.8	284.15	27	80.6	300.15	43	109.4	316.15
12	53.6	285.15	28	82.4	301.15	44	111.2	317.15
13	55.4	286.15	29	84.2	302.15	45	113	318.15
14	57.2	287.15	30	86	303.15			
15	59	288.15	31	87.8	304.15			

4.6.1.1 Adjusting the Temperature

1. From the Main Menu, select SENSOR SETUP and confirm.
2. Highlight the appropriate sensor if more than one sensor is attached and confirm.
3. Select CALIBRATE and confirm.
4. Select PROCESS TEMP and confirm.
5. Press ENTER when Stable, TEMP: XX.X is displayed. confirm to continue.
6. Adjust the Reading XX.X °C with the keypad and confirm.
7. CAL COMPLETE, OFFSET: X.X °C, confirm to continue.
8. MOVE PROBE TO PROCESS is displayed. Confirm.

4.6.2 pH (9184sc T.F.C. or 9184sc Chlorine + Acid only)

The manufacturer recommends calibrating the pH probe with a pH 4 and pH 7 buffer solution, regardless of sample pH.

4.6.2.1 Process pH 1 Point Sample

1. From the Main Menu, select SENSOR SETUP and confirm.
2. Highlight the appropriate sensor if more than one is attached and confirm.
3. Select CALIBRATE and confirm.
4. Select PROCESS PH and confirm.

5. Select 1 POINT SAMPLE and select the available Output Mode (Active, Hold, or Transfer) from the list box and confirm.
6. MOVE CLEAN PROBE TO SAMPLE is displayed. Confirm to continue.
7. VALUE: X.XX pH, TEMP: XX.X °C is displayed. Confirm to continue.
8. Adjust the SAMPLE VALUE: X.XX pH with the keypad and confirm.
9. COMPLETE, OFFSET: X.XX pH, SLOPE: XX.X% display. Confirm to continue.
10. Return Probe to Process displays. Confirm.

4.6.2.2 Process pH 2 Point Sample

1. From the Main Menu, select SENSOR SETUP and confirm.
2. Highlight the appropriate sensor if more than one is attached and confirm.
3. Select CALIBRATE and confirm.
4. Select PROCESS PH and confirm.
5. Select 2 POINT SAMPLE and select the available Output Mode (Active, Hold, or Transfer) from the list box and confirm.
6. MOVE CLEAN PROBE TO SAMPLE1 and confirm.
7. VALUE: X.XX pH, TEMP: XX.X °C is displayed. Confirm to continue.
8. Adjust the SAMPLE VALUE: X.XX pH to the known pH with the keypad and confirm.
9. MOVE CLEAN PROBE TO SAMPLE2, Press ENTER to Continue is displayed. Confirm.
10. VALUE: XX.XX pH, TEMP: XXX °C is displayed. Confirm to continue.
11. Adjust the second SAMPLE VALUE: X.XX pH to the known pH with the keypad and confirm.
12. VALUE: XX.XX pH, TEMP: XXX °C IS displayed. Confirm to continue.
13. COMPLETE, SLOPE: XXX.X%, OFFSET: X.XX pH is displayed. Confirm to continue.
14. Return Probe to Process displays. Confirm.

4.6.3 Concentration Calibration

9184sc

To test for Total Free Chlorine, use the Total Free Chlorine Calibration Method, with the manufacturer DPD test kits (Cat. No. 2105545). These test kits go with the DR/4000 and DR/2500 spectrophotometers and the DR/800 colorimeter.

Use the Pocket Colorimeter II™ for measuring free chlorine concentrations with the DPD method that is available from the manufacturer (Cat. No. 5870023) for all other 9184sc uses.

9185sc

To test for Ozone, use the Indigo Method, Ozone HR AccuVac test (Cat. No. 25180-25) that goes with the DR/4000, DR/2500, DR/890, and the Pocket Colorimeter II.

9187sc

To test for Chlorine Dioxide use the DPD Glycine Method, Chlorine Dioxide Reagent Set (Cat. No. 27709-00) that goes with the DR/4000, DR/2500, and DR/890, and Pocket Colorimeter II.

Note: Please reference the manufacturer catalog for other methods.

When performing the following steps, calculate the pH first then write down that number for reference.

4.6.3.1 Process Calibration

When performing these steps, calculate the pH first then write down that number for reference.

1. From the Main Menu, select SENSOR SETUP and confirm.
2. Highlight the appropriate sensor if more than one sensor is attached and confirm.
3. Select CALIBRATE and confirm.
4. Select PROCESS CONC and confirm.
5. Move Clean Probe to Sample, Press ENTER to continue is displayed. Confirm.
6. Confirm when Stable, VALUE: X.X nA, TEMP: XX.X °C.
7. (9184sc only) Adjust the pH VALUE: +X.XXpH (this is an actual value) with the keypad and confirm.
8. Adjust the TFC or CONCENTRATION VALUE (depending on instrument purchased): XXX.X ppb (this is an actual value) with the keypad and confirm.

Note: Refer to [section 4.6.3 on page 23](#). If adjusting the TFC value, use the Total Free Chlorine Method.

9. COMPLETE, SLOPE: nA/MG, OFFSET: uA is displayed and confirm to continue.
10. RETURN PROBE TO PROCESS is displayed and confirm.

4.6.4 Zero Calibration

The Zero Calibration can be performed in two different ways: chemically or electrically. To perform a Zero Calibration, refer to [section 4.6.5 on page 25](#).

For most users, the manufacturer recommends using the Electrical Zero Calibration. This uses a purely electrical means of setting the zero calibration point which is completely automated. Changing the setting first in CAL CONFIG is the only way to obtain a chemical zero calibration. The electrical is standard and the chemical is optional. See [section 4.6.5 on page 25](#).

In low range applications (<50ppb), it is recommended to use the Chemical Zero Method. The Chemical Zero Method requires a sample that is completely free of any oxidants. An oxidant free reference sample may be produced by leaving water in an open container for 24 hours. For best results use actual process water. Bubble the water, if possible, to speed up the oxidant evaporation.

The Upper Level Calibration point is obtained by reference to a laboratory method (process calibration).

4.6.4.1 Chemical Zero Calibration

1. From the Main Menu, select SENSOR SETUP and confirm.
2. Highlight the appropriate sensor if more than one is attached and confirm.
3. Select CALIBRATE and confirm.
4. Select ZERO and select the available Output Mode (Active, Hold, or Transfer) from the list box and confirm.
5. MOVE CLEAN PROBE TO SAMPLE and confirm.
6. VALUE: XX.X µg/l, TEMP: XX.X °C is displayed and confirm to continue.
7. Complete OFFSET: 0.0 uA is displayed and confirm to continue.
8. RETURN PROBE TO PROCESS is displayed and confirm.

4.6.5 Calibration Configuration

1. From the Main Menu, select SENSOR SETUP and confirm.
2. Highlight the appropriate sensor if more than one sensor is attached and confirm.
3. Select CALIBRATE and confirm.
4. Select CAL CONFIG and confirm.
5. OUTPUT MODE displays. Use the keypad to choose one of the following: ACTIVE, HOLD, TRANSFER, or CHOICE and confirm. (Returns to the CAL CONFIG menu.)
6. Select CAL CONFIG and confirm.
7. Select CAL ZERO and confirm.
8. Choose either ELECTRICAL or CHEMICAL and confirm. (Returns to the CAL CONFIG menu.)
9. Select CAL CONFIG and confirm.
10. Select CAL Delay and confirm.
11. Adjust the Day XX using the keypad and confirm. (Returns to the CAL CONFIG menu.)

4.7 Set Calibration Defaults

1. From the Main Menu, select SENSOR SETUP and confirm.
2. Highlight the appropriate sensor if more than one sensor is attached and confirm.
3. Select CALIBRATE and confirm.
4. Select DEFAULT SETUP and confirm.
5. ARE YOU SURE? displays. Confirm to continue.
6. Complete displays. Confirm to continue. (Returns to the CALIBRATE menu.)

Section 5 Maintenance

DANGER

Only qualified personnel should conduct the tasks described in this section of the manual.

5.1 Maintenance Schedule

The following schedule shows the minimum maintenance requirements for typical operation.

Maintenance Task	2 Months	3 Months	6 Months	Annually
Membrane			X	
Electrolyte			X	
pH (9184sc only)				X
Cleaning ¹		X		
Tubing				X
Calibration	X			

¹ Maintenance frequency is application dependent. Additional or less maintenance will be appropriate in some applications. The sensor must be cleaned before liquid standard verification or calibration.

5.2 Scheduled Maintenance

CAUTION

To familiarize yourself with handling precautions, dangers and emergency procedures, always review the Material Safety Data Sheets prior to handling containers, reservoirs, and delivery systems that contain chemical reagents and standards. Protective eye wear is always recommended when contact with chemicals is possible.

5.2.1 Replacing the Membrane

Note: When removing the probe from the sample, we recommend keeping the probe vertical with the membrane facing down. Avoid touching the active part of the membrane.

Replace the membrane every 6 months under typical operating conditions, or more frequently as experience dictates (Figure 12).

1. Shut off the sample supply. Remove the probe cable.
2. Unscrew the probe retaining ring. Remove the sensor.

Note: Removing the sensor may activate alarms. Ensure that removing the sensor will not affect plant operation by switching to maintenance mode.

3. Unscrew the electrode retaining ring and filling screw.

Note: Never pull sharply on the electrode when the filling screw is in place.

4. Remove the electrode. Pour out the electrolyte.
5. Unscrew the membrane.

Note: Do not re-install a used membrane. After changing the membrane, allow the probe to stabilize for at least three hours; recalibrate the sensor.

For re-assembly, see section 3.5.1 on page 11.

Figure 12 Disassembling the Sensor

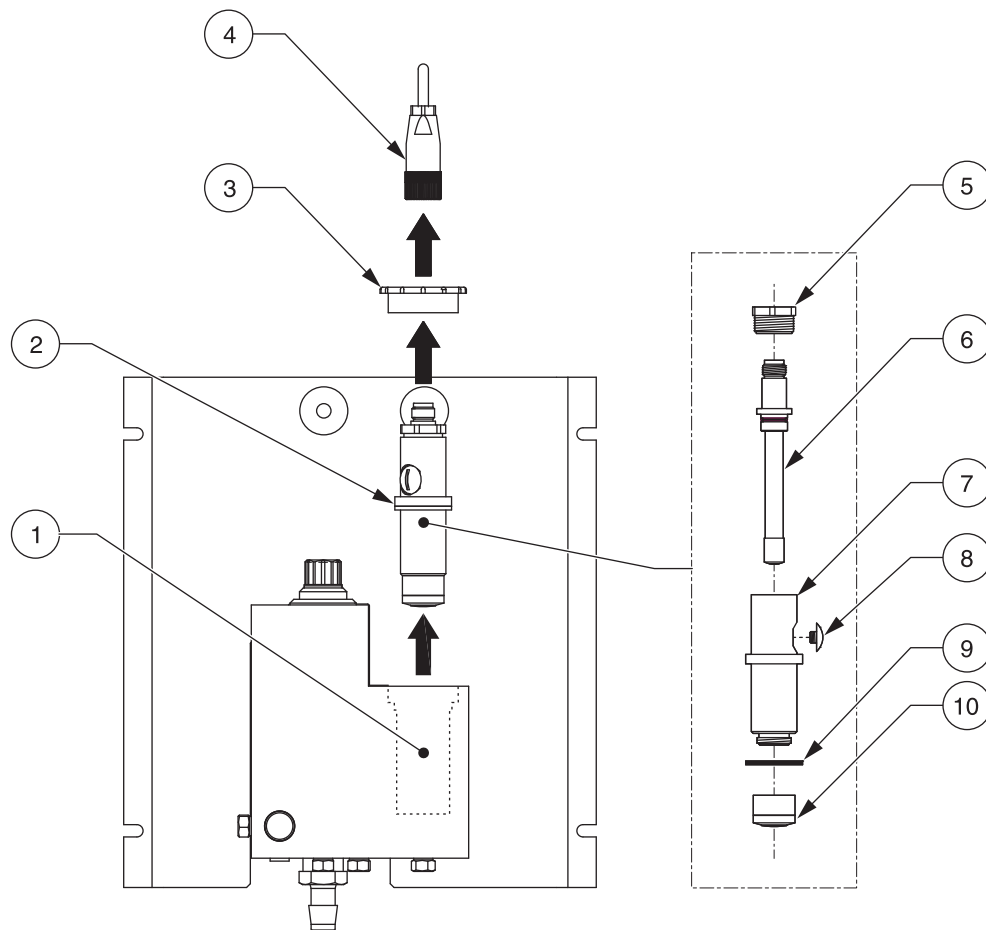

1. Probe Chamber	6. Measurement Electrode
2. Probe Assembly	7. Probe Body
3. Probe Retaining Nut	8. Filling Screw
4. Electrode Cable Connector	9. Probe Body Washer
5. Electrode Retaining Ring	10. Pre-mounted Membrane

5.2.2 Replacing the Tubing

Replace the tubing annually, if necessary.

5.2.3 Replacing the Electrolyte

Replace the electrolyte when changing the membrane. Refer to [section 3.5.1 on page 11](#) to replace the electrolyte.

5.2.4 Replacing the pH Electrode (9184sc only)

Replace the electrode 12 to 18 months depending on the application.

Section 6 Troubleshooting

6.1 Error Messages

Note: When an error occurs, the measurement values are replaced by dashes, (- - -).

Message Type	Error Message	Solution
Measurement-related Error Messages	CONC TOO HIGH	Check the current value, along with the calibration parameters. Check electrode.
	CONC TOO LOW	Check the current value, along with the calibration parameters. Check electrode.
	TEMPERATURE ERROR	Check for short-circuit or open circuit.
	INT. TOO LOW	Negative current. Check the electrode (electrolyte and membrane).
	INT. TOO HIGH	Ensure that there are no short-circuits on the measurement chain. Check the polarizing voltage.
	***** on the main display	No communication. Verify the connection and the cable. Test the 12V power supply.
	(At Connection time:) SENSOR MISSING FFFFFFFFFFFFFF displays	No communication. Verify the sensor is properly connected to the transmitter. Verify that the cable is not damaged. Test the 12V power supply. Open the sensor and change the board.
	COMMUNICATION ERROR	Open the sensor and verify that there is no humidity.
	TEMP TOO LOW	Temperature measurement is below -2°C . Verify that the actual temperature is not below -2°C . Verify the internal resistance of the NTC/K, which must be around 10 K. Connect the sensor simulator and verify the RAW value.
	TEMP TOO HIGH	Verify the actual temperature is not higher than 45°C . Connect the sensor simulator and verify the RAW value.
	RAW MEASUREMENT	Change the preamplifier.
	PH TOO LOW (9184sc only)	PH electrode is clogged, broken or too old. Calibrate the pH electrode. Clean the electrode. Replace the electrode.
PH TOO HIGH (9184sc only)	PH electrode is clogged, broken or too old. Calibrate the pH electrode. Clean the electrode. Replace the electrode.	
Calibration-related Error Messages	ΔT OUT OF LIMITS	The temperature difference between calibration and the theoretical sensor response is greater than the allowed limit. Limits: $\pm 20^{\circ}\text{C}$. Check temperature calibration (see 4.6.1 Temperature Sensor Calibration),
	OUT OF 4/20 mA	The measured value is out of the programmed scale range for analog outputs 1 and 2.

6.2 Warning Messages

Warning Display	Problem	Resolution
CAL FAIL SLOPE LOW	Slope is outside the limits.	Adjust so that it is within the limits by checking zero cal, ensuring the proper flow rate, and validating that it's clean. Be sure to put in the actual value and not the offset value when adjusting.
CAL FAIL SLOPE HIGH		Adjust so that it is within the limits by checking zero cal, ensuring the proper flow rate, and validating that it's clean. Be sure to put in the actual value and not the offset value when adjusting.
CAL TOO OLD	The last calibration was more than x days ago. (Setting from the sensor setup)	Calibrate the sensor. Set the calibration interval in the sensor setup.

Section 7 Replacement Parts and Accessories

7.1 Replacement Parts, Sensor Only

Description	Catalog Number
9184sc HOCl Chlorine Sensor	LXV430.99.00001
9184sc TFC Chlorine Sensor With pH	LXV432.99.00001
9185sc Ozone Sensor	LXV433.99.00001
9187sc Chlorine Dioxide Sensor	LXV434.99.00001

7.2 Replacement Parts

Description	Catalog Number
pH Electrode	368416,00000
9184sc set of 4 pre-mounted membranes	09184=A=3500
9185sc set of 4 pre-mounted membranes	09185=A=3500
9187sc set of 4 pre-mounted membranes	09187=A=3500
Electrolyte for the 9184sc	09184=A=3600
Electrolyte for the 9185sc	09185=A=3600
Electrolyte for the 9187sc	09187=A=3600
Replacement electrode for the 9184 sc	09184=A=1001
Replacement electrode for the 9185 sc	09185=A=1000
Replacement electrode for the 9187 sc	09184=A=1001
Replacement probe body	09184=C=4100
Filling screw	09184=C=1030
Syringe	560150,21957
Pre-assembled flow cell	LZY053
Mounting panel	LZY059
¼ in tubing adapter	09184=A=4020
Replacement gateway circuit board	LZX823
Replacement cable to transmitter	LZY105
Replacement electrode cable	09184=A=4300
Replacement pH probe cable	09184=A=4400
Manual	DOC023.52.00051

7.3 Optional Accessories

Description	Catalog Number
9180sc Acidification Unit	LZY051
9180sc Intermittent Flow Unit	LZY052
Versa Stand	5743200
125V Power Cord w/ Strain Relief	5448800
230V Power Cord w/ Strain Relief	5448900
Chlorine Free, Pocket Colorimeter II, with SwifTest DPD Reagent Dispenser	5870023
Chlorine, Free, DPD Test 'N-Tube, 10 mL sample, 50/test	2105545
Ozone HR AccuVac	2518025
Chlorine Dioxide Reagent Set	2770900

7.4 Extension Cables

Description	Catalog Number
Cable, sensor extension, 0,35 m	LZX847
Cable, sensor extension, 5 m	LZX848
Cable, sensor extension, 10 m	LZX849
Cable, sensor extension, 15 m	LZX850
Cable, sensor extension, 20 m	LZX851
Cable, sensor extension, 30 m	LZX852

Section 8 **Warranty, liability and complaints**

HACH LANGE GmbH warrants that the product supplied is free of material and manufacturing defects and undertakes the obligation to repair or replace any defective parts at zero cost.

The warranty period for instruments is 24 months. If a service contract is taken out within 6 months of purchase, the warranty period is extended to 60 months.

With the exclusion of the further claims, the supplier is liable for defects including the lack of assured properties as follows: all those parts that can be demonstrated to have become unusable or that can only be used with significant limitations due to a situation present prior to the transfer of risk, in particular due to incorrect design, poor materials or inadequate finish will be improved or replaced, at the supplier's discretion. The identification of such defects must be notified to the supplier in writing without delay, however at the latest 7 days after the identification of the fault. If the customer fails to notify the supplier, the product is considered approved despite the defect. Further liability for any direct or indirect damages is not accepted.

If instrument-specific maintenance and servicing work defined by the supplier is to be performed within the warranty period by the customer (maintenance) or by the supplier (servicing) and these requirements are not met, claims for damages due to the failure to comply with the requirements are rendered void.

Any further claims, in particular claims for consequential damages cannot be made.

Consumables and damage caused by improper handling, poor installation or incorrect use are excluded from this clause.

HACH LANGE GmbH process instruments are of proven reliability in many applications and are therefore often used in automatic control loops to provide the most economical possible operation of the related process.

To avoid or limit consequential damage, it is therefore recommended to design the control loop such that a malfunction in an instrument results in an automatic change over to the backup control system; this is the safest operating state for the environment and the process.

Appendix A 9184sc Theory of Operation

A.1 Theory of Operation

The 9184sc Chlorine Analyzer is an on-line, single-channel industrial analyzer that measures free chlorine in drinking water treatment plants, distribution networks, and other applications that require monitoring free chlorine at the ppb and ppm levels.

This instrument uses an amperometric method to measure HOCl concentration. A membrane allows the selective diffusion of HOCl molecules to the amperometric sensor (Figure 1 on page 6). The measurement is compensated for pH and temperature.

A.1.1 Principle of Operation

Specific terms exist to mention the different species of chlorine:

- Active Chlorine HOCl (hypochlorous acid)
It is the most powerful disinfectant, up to 100 times more efficient than hypochlorite
- Total Free Chlorine (TFC): HOCl + ClO⁻:
It is composed of dissolved chlorine (at low pH values), hypochlorous acid gas and hypochlorite ion. These species coexist, their relative proportion is depending on pH and temperature (see curve below for a dissociation at 25°C).
- Total Combined Chlorine (TCC):
It results from the addition of total free chlorine and chloramines (mono-, di- and trichloramine). The 9184 sc does not measure this parameter.

Fraction of Cl₂, HOCl and ClO⁻ react as a function of pH (Figure 13).

Figure 13 Dissociation Curve

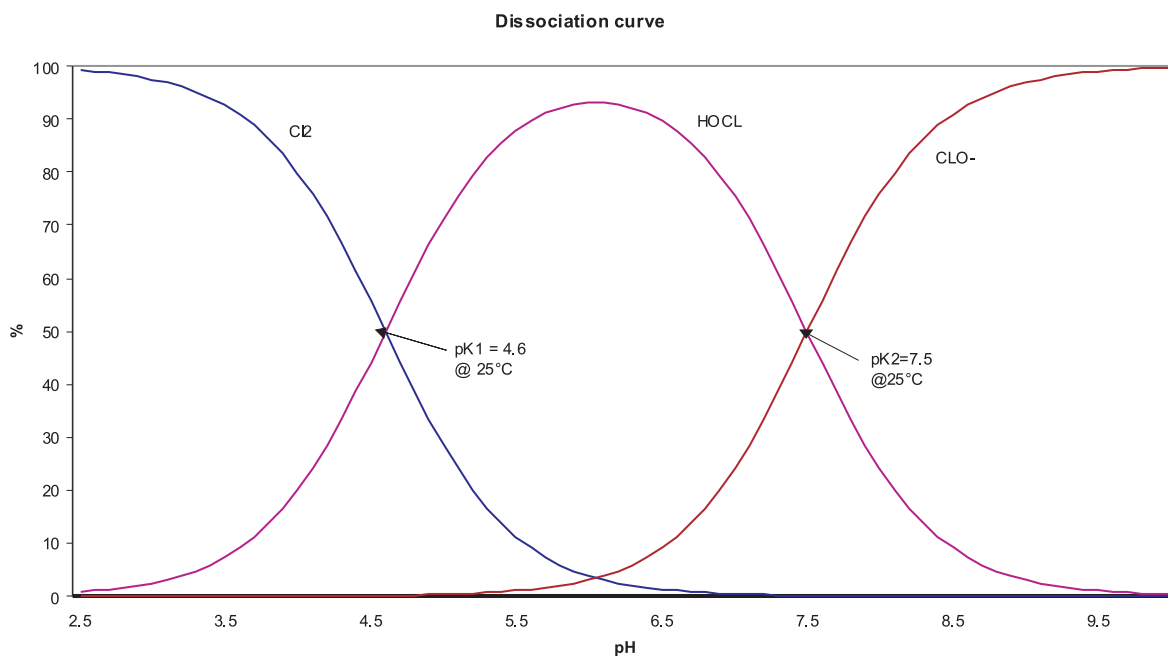

The dissociation reactions are as follow:

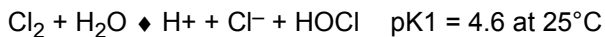

It is also important to notice that the dissociation constants are temperature-dependent (the equipment takes into account this element).

The amperometric sensor consists of:

- a gold working electrode (cathode) where the main reaction occurs
- a silver counter-reference electrode (anode)
- KCl electrolyte
- a microporous membrane selective to HOCl

The HOCl molecules in the sample diffuse through the membrane to a thin region between the membrane and the cathode that contains the electrolyte.

A constant potential is applied to the working electrode where HOCl is reduced according to the reaction:

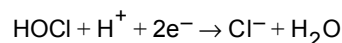

At the silver electrode (anode) the silver is oxidized to Ag^+ :

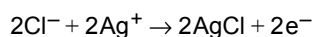

The reduction in HOCl at the cathode generates a current that is directly proportional to its partial pressure in the sample.

The electrochemical reaction and diffusion through the membrane are dependent upon temperature. Consequently, the measurement cell contains a temperature sensor that allows for automatic temperature compensation.

In the acidification version an additional analyzer version offers the possibility to measure samples with a high pH value. The sample pH is kept constant between 5.5 and 6.5 by continuously adding acid solution. At such pH levels, all ClO^- ions turn into HOCl, thus enabling the sensor to measure TFC.

Appendix B 9185sc Theory of Operation

B.1 Theory of Operation

The 9185sc Ozone Analyzer is an on-line, single-channel industrial analyzer that measures ozone in drinking water treatment plants, distribution networks, and other applications that require monitoring ozone at the ppb and ppm levels.

This instrument uses an amperometric method to measure O_3 concentration. A membrane allows the selective diffusion of O_3 molecules to the amperometric sensor (Figure 1 on page 6). The measurement is compensated for pH and temperature.

B.1.1 Principle of Operation

Ozone is a gas that is highly soluble in water (13 times more than oxygen). It is unstable when dissolved in water.

Effects on solubility:

- Some parameters e.g. temperature and pH can influence the stability of the measurement. The solubility of ozone in water decreases rapidly with temperature.

Effects of pH: Ozone reacting with OH^- hydroxide ions: the greater the number of these ions (high pH), the greater the degree of breakdown. Conversely, at a low pH, breakdown will be slower (Figure 14).

Figure 14 Time of Breakdown of Dissolved Ozone

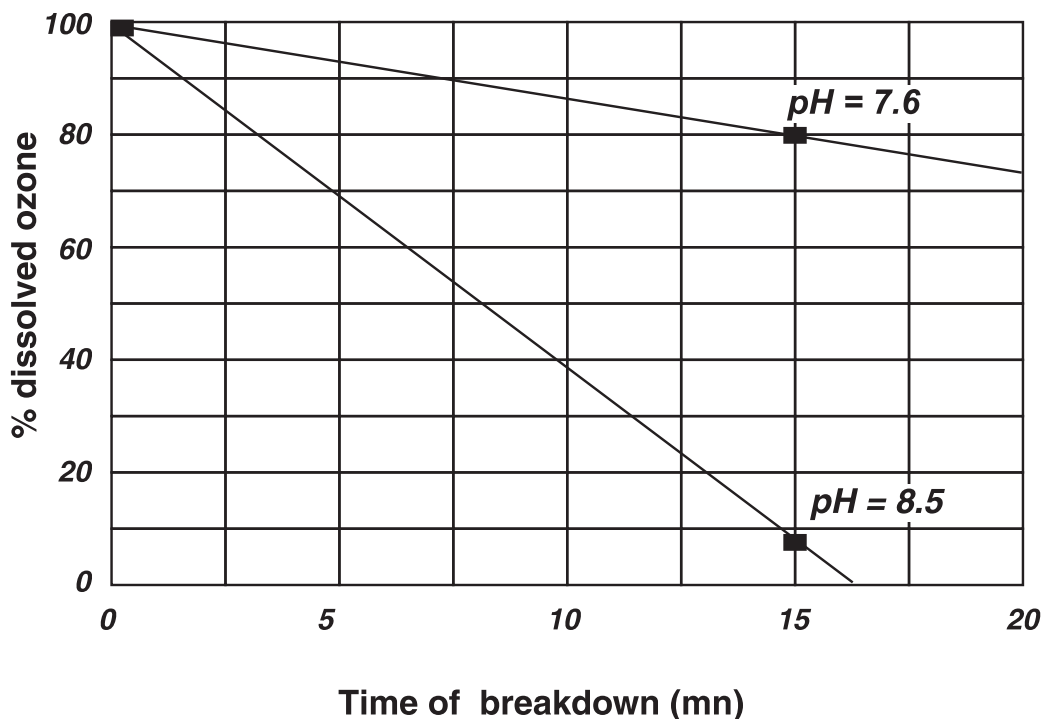

Finally, it is worth noting that, as the OH^- ion is a by-product of ozone breakdown in water, the reaction between OH^- and O_3 can be sustained until complete disappearance of the ozone. This is more pronounced if air is mixed with the water sample.

The exposure to free air of ozone water results in significant degassing: as the ozone content of ambient air is very low compared to that of the sample, exchange therefore occurs, with rapid loss of ozone in the sample.

This problem is even more pronounced if air/water mixing occurs. All of these phenomena, therefore, require that certain precautions be taken concerning the sampling line (section 3.2 on page 10 and section 3.3 on page 10).

C.1 Theory of Operation

The 9187sc Chlorine Dioxide Analyzer is an on-line, single-channel industrial analyzer that measures chlorine dioxide in drinking water treatment plants, distribution networks, and other applications that require monitoring chlorine dioxide at the ppb and ppm levels.

This instrument uses an amperometric method to measure chlorine dioxide concentration. A membrane allows the selective diffusion of ClO₂ molecules to the amperometric sensor (Figure 1 on page 6). The measurement is compensated for temperature.

C.1.1 Principle of Operation

Measurement is carried out using an amperometric method after diffusion of the chlorine dioxide molecules through a membrane. The molecules of chlorine dioxide contained in the sample diffuse through the membrane and are then found in an electrolyte zone of very slight thickness between the membrane and the cathode. A constant work potential is applied to the work electrode (cathode) where ClO₂ is reduced according to the reaction:

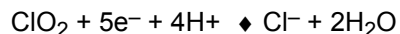

At the silver electrode (anode) the silver is oxidized to:



The reduction in chlorine dioxide at the cathode generates a current which is directly proportional to the partial pressure of it in the sample. The electrochemical reaction and diffusion through the membrane are dependent upon temperature, consequently the measurement cell is fitted with a temperature sensor which enables the automatic compensation of measurement variations according to temperature.

Appendix D Modbus Register Information

Table 2 Sensor Modbus Registers

Tag Name	Register #	Data Type	Length	R/W	Description
Main Measurement Parameter in mg/L	40001	Float	2	R	Concentration Measurement Tag in mg/L
pH Measurement Param.	40003	Float	2	R	pH Measurement Tag
Temperature measurement	40005	Float	2	R	Temperature measurement
Current Measurement Parameter in μ A	40007	Float	2	R	Current measurement in μ A
Main Measurement Parameter in ppm	40009	Float	2	R	Concentration Measurement Tag in ppm
Main Measurement Parameter in ppb	40011	Float	2	R	Concentration Measurement Tag in ppb
Main Measurement Parameter in μ g/L	40013	Float	2	R	Concentration Measurement Tag in μ g/L
Current Measurement Parameter in nA	40015	Float	2	R	Current measurement in nA
Raw pH measurement	40017	Float	2	R	Raw pH measurement
mV Raw measurement	40019	Float	2	R	Raw ORP measurement
Raw Temperature measurement	40021	Float	2	R	Raw Temperature measurement
AutoRange Concentration in ppX	40023	Integer	1	R	Auto Ranging Tag in ppX
AutoRange Concentration in Xg/L	40024	Integer	1	R	Auto Ranging Tag in xg/L
AutoRange Current	40025	Integer	1	R	Auto Ranging redirection of nA- μ A units
Concentration Tag-based	40026	Integer	1	R	Redirection tag for concentration ppm-mg/L units
Temperature Tag-based	40027	Integer	1	R/W	Redirection tag for temperature unit ($^{\circ}$ C- $^{\circ}$ F)
Sensor Name[0]	40028	Integer	1	R/W	Sensor Name[0]
Sensor Name[1]	40029	Integer	1	R/W	Sensor Name[1]
Sensor Name[2]	40030	Integer	1	R/W	Sensor Name[2]
Sensor Name[3]	40031	Integer	1	R/W	Sensor Name[3]
Sensor Name[4]	40032	Integer	1	R/W	Sensor Name[4]
Sensor Name[5]	40033	Integer	1	R/W	Sensor Name[5]
Function code	40034	Integer	1		Function code
Next Step	40035	Integer	1		Next Step
Password	40036	Pass	1	R/W	Password
Serial Number[0]	40037	Integer	1	R/W	Serial Number[0]
Serial Number[1]	40038	Integer	1	R/W	Serial Number[1]
Serial Number[2]	40039	Integer	1	R/W	Serial Number[2]
Application toogle	40040	Integer	1	R/W	9184..9187 applications
Active Concentration unit	40041	Integer	1	R/W	Active concentration unit (ppm or mg/L)
Concentration unit toogle	40042	Bit	1	R/W	Concentration unit toogle (ppm-mg/L)
Temperature unit toogle	40043	Bit	1	R/W	Temperature unit toogle ($^{\circ}$ C- $^{\circ}$ F)
Concentration offset unit	40044	Integer	1	R	Concentration offset unit (na- μ A)
Compensation pH toogle	40045	Integer	1	R/W	Compensation pH toogle (manual-auto)
pH display format toogle	40046	Bit	1	R/W	pH display format XX.X or XX.XX

Modbus Register Information

Table 2 Sensor Modbus Registers (continued)

Tag Name	Register #	Data Type	Length	R/W	Description
---	40047	Integer	1	R/W	Internal use
---	40048	Integer	1	R/W	Internal use
Averaging	40049	Integer	1	R/W	Averaging
Automatic/Manual temperature toogle	40050	Bit	1	R/W	Automatic/Manual temperature toogle
Manual Temperature unit	40051	Integer	1	R/W	Manual Temperature unit
Manual Temperature	40052	Float	2	R/W	Manual Temperature
Manual pH	40054	Float	2	R/W	Manual pH
50/60 Hz toogle	40056	Bit	1	R/W	50/60 Hz toogle
Output Mode	40057	Integer	1	R	Internal use
---	40058	Integer	1	R	Internal use
---	40059	Integer	1	R	Internal use
---	40060	Integer	1	R	Internal use
---	40061	Integer	1	R	Internal use
---	40062	Integer	1	R	Internal use
---	40063	Integer	1	R	Internal use
---	40064	Integer	1	R	Internal use
---	40065	Float	2	R	Internal use
---	40067	Float	2	R	Internal use
---	40069	Float	2	R	Internal use
Temperature Offset	40071	Float	2	R/W	Temperature Offset
Temperature Offset unit	40073	Integer	1	R	Internal use
pH Buffer 1 Measurement	40074	Float	2	R	Internal use
pH Buffer 2 Measurement	40076	Float	2	R	Internal use
Cal Conc Measurement	40078	Float	2	R	Internal use
Cal TFC Measurement	40080	Float	2	R	Internal use
Output Mode	40082	Integer	1	R	Internal use
Software version	40083	Float	2	R	Software version
Serial Number String[0]	40085	Integer	1	R/W	Internal use
Serial Number String[2]	40086	Integer	1	R/W	Internal use
Serial Number String[4]	40087	Integer	1	R/W	Internal use
Serial Number String[6]	40088	Integer	1	R/W	Internal use
Serial Number String[8]	40089	Integer	1	R/W	Internal use
Serial Number String[10]	40090	Integer	1	R/W	Internal use
pH Offset	40091	Float	2	R	pH Calibration Offset
pH Slope	40093	Float	2	R	pH Calibration slope
Concentration Offset	40095	Float	2	R	Concentration Offset
Concentration Slope	40097	Float	2	R	Concentration Slope
Calibration Return Status	40099	Integer	1	R	Calibration Return Status
Time between two calibrations	40100	Integer	1	R/W	Time between two calibrations
Concentration zero toogle	40101	Integer	1	R/W	Concentration zero toogle (electrical-chemical)
Time from start up	40102	Integer	1	R	Time the system is running
Time to exchange Humidity bag	40103	Integer	1	R	Time the humidity bag has been used

Table 2 Sensor Modbus Registers (continued)

Tag Name	Register #	Data Type	Length	R/W	Description
DriverVersion_float	40104	Float	2	R	Driver version
---	40106	Float	2	R	Internal use
Measurement Logging Interval	40108	Integer	1	R/W	Sensor Data logging interval
Temperature Logging Interval	40109	Integer	1	R/W	Temperature logging interval

Index

A		P	
Attaching the Sensor	15	Probe Components	11
D		R	
Dissociation Curve.....	35	Replacement Parts and Accessories	31
E		S	
Error Messages	29	Safety	5
I		Sample Line	10
Instrument Specifications	3	sc100 Warning Messages	29
M		Sensor	
Mounting		Data Logging	19
Installation Considerations.....	10	Sensor Cable	
O		Wiring.....	16
Optional pH.....	15	T	
		Theory 9184sc.....	35
		Theory 9185sc.....	37
		Theory 9187sc.....	39

HACH COMPANY World Headquarters

P.O. Box 389, Loveland, CO 80539-0389 U.S.A.
Tel. (970) 669-3050
(800) 227-4224 (U.S.A. only)
Fax (970) 669-2932
orders@hach.com
www.hach.com

HACH LANGE GMBH

Willstätterstraße 11
D-40549 Düsseldorf, Germany
Tel. +49 (0) 2 11 52 88-320
Fax +49 (0) 2 11 52 88-210
info-de@hach.com
www.de.hach.com

HACH LANGE Sàrl

6, route de Compois
1222 Vérenaz
SWITZERLAND
Tel. +41 22 594 6400
Fax +41 22 594 6499

